

INF 115

★ Forum '91

27th Forum on the Geology of Industrial Minerals

Industrial Minerals of Alberta and
British Columbia, Canada

Proceedings

Banff, Alberta, Canada

Sponsored by

Geological Survey Branch
B.C. Ministry of Energy, Mines
and Petroleum Resources

Alberta Geological Survey
Alberta Research Council

Open File 1991-23

Information Series 115

May 5-10, 1991

IVES
rmat
es



**INDUSTRIAL MINERALS OF
ALBERTA AND BRITISH COLUMBIA
CANADA**

**Proceedings of the 27th Forum on the Geology
of Industrial Minerals
May 5 to May 10, 1991, Banff, Alberta**

Compiled and edited by:

Z.D. Hora,
W.N. Hamilton,
B. Grant and
P.D. Kelly

ALBERTA
BRITISH COLUMBIA
CANADA

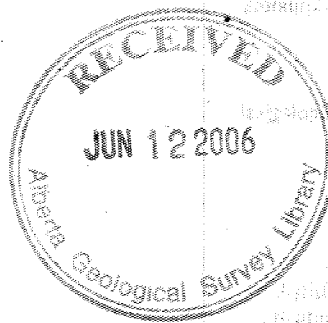

British Columbia
Geological Survey Branch

Open File 1991-23

Alberta Geological Survey

Information Series 115

Canadian Cataloguing in Publication Data

Forum on the Geology of Industrial Metals (27th : 1991 :
Banff, Alta.)

Industrial minerals of Alberta and British Columbia
Canada

(Open file, ISSN 0835-3530 ; 1991-23)

Joint publication of the British Columbia Geological
Survey and the Alberta Geological Survey.

-- Cf. p. ii.

Includes bibliographical references: p.
ISBN 0-7718-9149-0

1. Industrial minerals - Geology - Alberta -
Congresses. 2. Industrial minerals - Geology - British
Columbia - Congresses. 3. Industrial minerals industry -
Alberta - Congresses. 4. Industrial minerals industry -
British Columbia Congresses. I. Hora, Z.D. II. British
Columbia Geological Survey Branch. III. Alberta
Geological Survey. IV. Title. V. Series: Open file (British
Columbia. Geological Survey Branch) ; 1991-23.

TN799.5.F67 1991

553.6'09712

C92-092040-3

VICTORIA
BRITISH COLUMBIA
CANADA

January 1992

CHRONOLOGY OF THE FORUMS ON THE GEOLOGY OF INDUSTRIAL MINERALS

1st	1965	Columbus, Ohio
2nd	1966	Bloomington, Indiana
3rd	1967	Lawrence, Kansas
4th	1968	Austin, Texas
5th	1969	Harrisburg, Pennsylvania
6th	1970	Ann Arbor, Michigan
7th	1971	Tampa, Florida
8th	1972	Iowa City, Iowa
9th	1973	Paducah, Kentucky
10th	1974	Columbus, Ohio
11th	1975	Kalispell, Montana
12th	1976	Atlanta, Georgia
13th	1977	Norman, Oklahoma
14th	1978	Albany, New York
15th	1979	Golden, Colorado
16th	1980	St. Louis, Missouri
17th	1981	Albuquerque, New Mexico
18th	1982	Bloomington, Indiana
19th	1983	Toronto, Ontario
20th	1984	Baltimore, Maryland
21st	1985	Tucson, Arizona
22nd	1986	Little Rock, Arkansas
23rd	1987	North Aurora, Illinois
24th	1988	Greenville, South Carolina
25th	1989	Portland, Oregon
26th	1990	Charlottesville, Virginia
27th	1991	Banff, Alberta

NOTICE

This is a joint publication of the British Columbia Geological Survey and the Alberta Geological Survey. To ensure timely distribution of information the material contained herein was not edited to our normal standards. References were not checked for completeness or accuracy and readers are directed to the individual authors for further information or clarification of data.

TABLE OF CONTENTS

<p>PREFACE vii</p> <p>CANADIAN INDUSTRIAL MINERAL EXPORTS: A GLOBAL CONTRIBUTION By Michel Prud'homme 1</p> <p>INDUSTRIAL MINERALS IN ALBERTA By Wylie N. Hamilton 9</p> <p>OVERVIEW OF INDUSTRIAL MINERALS IN SASKATCHEWAN By Paul Guliov 19</p> <p>GEOLOGICAL SETTING AND DEVELOPMENT AND POTENTIAL OF SELECTED INDUSTRIAL MINERALS IN SOUTHEASTERN BRITISH COLUMBIA By Stephen B. Butrenchuk 37</p> <p>GEOLOGICAL HISTORY OF THE WESTERN CANADA SEDIMENTARY BASIN By Grant D. Mossop 45</p> <p>AN OVERVIEW OF THE SASKATCHEWAN POTASH INDUSTRY By Keith S. Crosby 47</p> <p>REGIONAL GEOLOGY OF THE MOUNT BRUSILOF CARBONATE-HOSTED MAGNESITE DEPOSIT, SOUTHEASTERN BRITISH COLUMBIA, CANADA By George J. Simandl, Kirk D. Hancock, Dan Z. Hora, Mary E. MacLean and Suzanne Paradis 57</p> <p>ENVIRONMENTAL SIGNIFICANCE OF MAGNESIUM OXIDE AS AN INDUSTRIAL MINERAL By Tim Sears and Hagen Schultes 67</p> <p>MAGCAN AND MAGNESIUM By A.H. Wheeler 71</p> <p>BARITE AND ITS USES AS A FILLER AND EXTENDER By Ronald J. Singh 75</p> <p>GEOLOGY OF TALC AND CHLORITE DEPOSITS IN MONTANA By Richard B. Berg 81</p> <p>THE LANG BAY KAOLIN RESOURCE, BRITISH COLUMBIA By Lauch Farris and Colin C. Harvey 93</p>	<p>OPPORTUNITIES FOR HIGH VALUE-ADDED PAPERMAKING MINERAL PIGMENTS IN WESTERN NORTH AMERICA By George Ionides 99</p> <p>THE GEOLOGY OF SANDS AND GRAVELS IN THE BOW VALLEY CORRIDOR, ALBERTA By W. A. Dixon Edwards 103</p> <p>THE UPPER DEVONIAN PALLISER FORMATION IN THE TYPE AREA NEAR EXSHAW, ALBERTA By N.C. Meijer Drees and D.I. Johnston 109</p> <p>THE BEARBERRY ULTRA SOUR GAS PROJECT By Paul Kitzan and Louis Auger 111</p> <p>YTTRIUM ENRICHED PHOSPHORITES IN THE FERNIE BASIN, SOUTHEASTERN BRITISH COLUMBIA By Jennifer Pell 117</p> <p>EVALUATION OF THE FERNIE PHOSPHORITE AND PRINCETON ZEOLITES: POTENTIAL FOR ROCK PHOSPHATE ZEOLITE FERTILIZER USE By Virginia Marcille-Kerslake 125</p> <p>A MASSIVE SKARN-HOSTED ANDRADITE DEPOSIT NEAR PENTICTON, BRITISH COLUMBIA By H.C. Grond, R. Wolfe, J.H. Montgomery and G.H. Giroux 131</p> <p>GEOLOGY, MINERALOGY AND PROCESSING OF MOUNT RIORDAN GARNET ORES By G.I. Mathieu, M.R. Boisclair and R. Wolfe 135</p> <p>DIAMONDS IN SASKATCHEWAN By Malcolm Richard Gent 147</p> <p>WATER FILTRATION USING PERLITE FROM THE FRENIER DEPOSIT OF BRITISH COLUMBIA By R.D. Giles and G.W. Poling 159</p> <p>ROCKS IN MOTION By Donald F. Gunning 167</p> <p>AMMOLITE, AN ORGANIC GEMSTONE FROM ALBERTA By Rene Vandervelde 171</p>
--------------------------------------------------------------------------------------------------------------------------------------------------------------------------------------------------------------------------------------------------------------------------------------------------------------------------------------------------------------------------------------------------------------------------------------------------------------------------------------------------------------------------------------------------------------------------------------------------------------------------------------------------------------------------------------------------------------------------------------------------------------------------------------------------------------------------------------------------------------------------------------------------------------------------------------------------------------------------------------------------------------------------------------------------------------------------------------------------------------------------------------------------------------------------------------------------------------------------------------------------------------------------------------------------------------------------------------------------------------------------------------------------------------------------------------------------------------------------------------------------------------------------------------------------------------------------------------------------------------------------	--------------------------------------------------------------------------------------------------------------------------------------------------------------------------------------------------------------------------------------------------------------------------------------------------------------------------------------------------------------------------------------------------------------------------------------------------------------------------------------------------------------------------------------------------------------------------------------------------------------------------------------------------------------------------------------------------------------------------------------------------------------------------------------------------------------------------------------------------------------------------------------------------------------------------------------------------------------------------------------------------------------------------------------------------------------------------------------------------------------------------------------------------------------------------------------------------------------------------------------------------------------------------------------------------------------------------------------------------------------------------------------------------------------------------------------------------------------------------------------------------------------------------------------------------------------------------------------------------------------------------------------------------------------------------------------

**FOUR MARL DEPOSITS WITHIN THE SKEENA
RIVER VALLEY, NORTHWESTERN BRITISH
COLUMBIA (103I/16W, 103P/1W, 93M/5E)**
By M.L. Malott 173

**1992 FORUM ON THE GEOLOGY OF INDUSTRIAL
MINERALS, WEST VIRGINIA**
By Claudette M. Simard 179

APPENDIX 1: POSTER ABSTRACTS 181

APPENDIX 2: LIST OF REGISTRANTS 211

PREFACE

The 27th Forum on the Geology of Industrial Minerals was held in Banff, Alberta, from May 5 through May 10, 1991. For the first time in its 27 year history, the Forum had two sponsoring agencies - the Alberta Geological Survey and the British Columbia Geological Survey. The Banff location was chosen both for its attractive setting in the Canadian Rocky Mountains and because it provided easy access to industrial minerals producers in both provinces of Alberta and British Columbia. Visits to operations were organized as three optional one-day field trips.

The Forum was attended by 150 industrial minerals specialists from Canada, the United States and Great Britain. About two thirds of the participants were from private industry and the rest were employees of various government agencies.

The Forum consisted of two full days of technical sessions with Alberta and British Columbia each sponsoring one day. The program focussed on the industrial mineral resources of the two provinces, but included contributions also from neighboring areas of Saskatchewan and Montana on some of their resources. Optional field trips covered such topics as the geology and industrial minerals of the Bow Valley between Banff and Jumping Pound in Alberta, and significant industrial minerals producers of the southern Rocky Mountain Trench in British Columbia. Over two thirds of the Forum attendees took at least one of the field trips.

The Alberta field trip visited the building stone operation of Thunderstone Quarries Ltd., and the Lafarge Canada Ltd. cement plant near Exshaw, the Continental Lime Ltd. plant and quarry, the Shell Resources Ltd. Jumping Pound gas and sulphur plant and the Burnco Rock Products Ltd. sand and gravel pit near Canmore. Field trips into British Columbia included visits to the Mount Moberly silica sand quarry and processing plant of Mountain Minerals Co. Ltd., the Nicholson lump silica quarry of Silicon Metaltech Inc., the Windermere gypsum quarries of Westroc Industries Ltd. and Mount Brussilof magnesite quarry of Baymag Mines Ltd. The gracious hospitality provided by the companies is gratefully acknowledged, most notably the explanations of individual operations provided by respective employees.

The 27th Forum was exceptionally well supported financially. Contributions by a number of organizations helped considerably to underwrite the costs of special activities and publications. These organizations included:

Alberta Energy - Active Minerals Limited - BAYMAG - British Columbia Trade Development Corporation - Burnco Rocks Products Ltd. - Cardinal River Coal Ltd. - CNRAIL - Cominco Exploration - Continental Lime Ltd. - Inland Cement Limited - International Marble & Stone Company Ltd. - I-XL Industries Ltd. - Mountain Minerals Co. Ltd. - Canada-British Columbia Mineral Development Agreement - Society of Economic Geologists Foundation, Inc. - Tilbury Cement Limited - Trigg, Woollett, Olson Consulting Ltd. - Trimac Transportation Services Ltd. - Westroc Industries Ltd.

New-world Gemstone provided support by donating the rhodonite and jade samples for the registration package.

The support given by the Alberta Geological Survey and British Columbia Geological Survey toward the organization and hosting of the meeting is greatly appreciated. The members of the planning committee spent a considerable amount of personal time to ensure the smooth executions of the meeting's program. A special appreciation goes to Patricia D. Kelly, who performed the task of transforming the collection of manuscripts into a printable document.

And finally, a special thanks to all Forum speakers and authors, who had to find the time and resources to prepare the manuscripts and present their papers.

- Z.D. Hora, *Industrial Mineral Specialist,*
Geological Survey Branch,
B.C. Ministry of Energy Mines and Petroleum Resources

- W.N. Hamilton, *Economic Minerals Geologist*
Alberta Geological Survey,
Alberta Research Council

CANADIAN INDUSTRIAL MINERAL EXPORTS: A GLOBAL CONTRIBUTION

By Michel Prud'homme

Mineral Policy Sector, Energy, Mines and Resources,
Canada, Ottawa, Ontario

INTRODUCTION

The importance of industrial minerals to the Canadian economy is demonstrated in their daily, routine usage in virtually every economic activity in the country. To name just a few examples, sand and gravel, crushed stone and salt are widely used in road de-icing; acid-grade fluorspar and pharmaceutical-grade feldspar are utilized in dentistry; silica, nepheline syenite and limestone are basic materials for glass manufacture; and potash, sulphur, lime and peat moss are widely consumed by the agricultural sector. However, the extent of the contribution of industrial minerals is perhaps not as visible as that of the "glamour" metals such as gold, nickel and copper. Here are some figures that perhaps put the industrial minerals sector in the proper perspective.

First, production: over the last thirty years, the contribution of industrial minerals within the metal and minerals sector in Canada has ranged between 23 per cent and 36 per cent of total value of production from the Canadian mining industry; at an average of 30 per cent, industrial minerals have remained an important and stable component of the Canadian economy.

Second, employment: the industrial minerals industry operated more than 925 plants across Canada and provided some 24 700 jobs in 1990. The employment in this sector accounts for one-third of all jobs in the Canadian mining sector. The construction material segment of the industrial minerals industry employs close to 13 700 workers while the other non-metallic segment provides 11 000 jobs; the largest single employer in this latter category is the potash industry providing 3 700 jobs, followed by the asbestos industry with 2 600 jobs.

CONTRIBUTION OF INDUSTRIAL MINERALS TO CANADA

In 1989, total Canadian production of industrial minerals was valued at \$5.4 billion and accounted for 0.85 per cent of the Gross Domestic Product. Exports of industrial minerals were estimated at \$2.95 billion, a 2.1 per cent contribution to our total merchandise exports in 1989.

Over the last 10 years, the value of industrial minerals production in Canada rose 28 per cent from \$4.2 billion to \$5.4 billion in current dollars (Figure 1); almost all this increase was reported in the construction material segment as major gains were registered in the production values of cement (up 34%), sand and gravel (up 27%) and stone (up 24%) (Table 1). The value of production for the other non-metallics remained static: significant increases reported in sales of titanium dioxide, peat and salt coincided with major declines in asbestos sales. Seven non-metallic minerals accounted for close to 94 per cent of total non-metallics sales in 1989. During the past ten years, sales of titanium dioxide, gypsum, peat and salt have grown rapidly while potash and sulphur

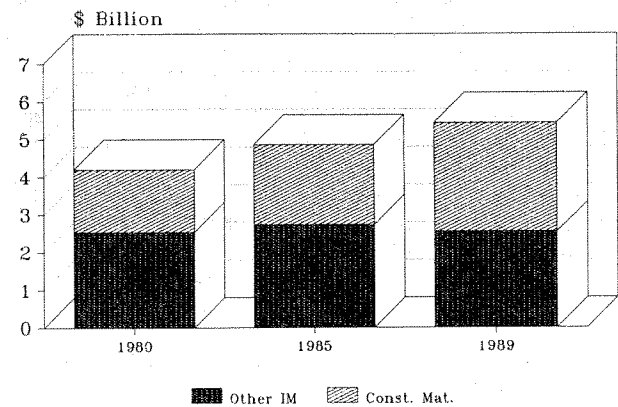

Figure 1. Industrial minerals production value (current \$).

sales have suffered from high volatility in prices and sales volumes due to international market conditions.

The increases in sales registered for gypsum, peat and salt were mainly due to simultaneous gains in unit values and tonnages; the small increases reported in sales of sulphur were mostly due to a significant rise in its unit value as shipment tonnages dropped dramatically by 30 per cent in 1989 compared to 1980 levels. The 60 per cent drop in asbestos sales revenues resulted from a combination of lower prices and reduced shipment tonnages, the latter factor contributing to two-thirds of this decline.

TABLE 1
CANADIAN INDUSTRIAL MINERALS
PRODUCTION VALUES

	1980	1989	Change
	\$ Million		
Construction Materials	1,669	2,890	+73%
Cement	581	998	+72%
S & G	508	837	+64%
Stone	341	632	+85%
Other Non-Metallics	2,532	2,542	+0.4%
TiO ₂	c	c	+135%
Peat	44	100	+127%
Salt	122	228	+87%
Asbestos	614	267	-60%
	4,201	5,432	+29%

IMPORTANCE OF INDUSTRIAL MINERAL EXPORTS FOR CANADA

In 1989, export sales of Canadian industrial minerals generated close to \$2.95 billion in revenues (Figure 2). Potash, sulphur, and asbestos were the major contributors, together accounting for some 76 per cent share of this total. However, the dominance of these three industrial minerals in Canadian exports has been continuously declining since 1980 from 98 per cent in 1980 to 76 per cent in 1989 as exports of other non-metallics have grown with the exploiting of existing opportunities in offshore markets.

Of special note, major increases in Canadian exports of industrial minerals were reported in this period for gypsum, cement and titanium dioxide, which contributed 30 per cent, 21 per cent and 11 per cent, respectively, of the increase in exports revenues registered between 1980 and 1989. Other minerals also contributed to this increase and included peat (10%), dimension stone (10%), and salt (8%). Significant gains in sales were also reported for nepheline syenite, crushed stone, talc and sand and gravel with a combined contribution of 8%.

The export pattern for Canadian industrial minerals has not changed significantly in the last ten years, showing the relative stability that Canadian producers benefit in the marketplace. Setting aside potash, sulphur, titanium dioxide and asbestos which are clearly oriented toward international markets, some variations indeed occurred in Canadian exports as certain suppliers of industrial minerals took advantage of market opportunities. Of special interest, peat, graphite, granite and talc have demonstrated important growth in shipment tonnages to foreign markets.

The importance of the unit value as an indicator for international trade has been evaluated for most Canadian industrial minerals. In 1989, minerals that had a unit value above \$100 per tonne were mostly exported (Table 2). Two exceptions here were talc with only 54 per cent of its production in Canada being exported despite a unit value in the range of \$100-110 per tonne, and dimensional granite with 35 per cent of its production being exported and unit values above \$300 per tonne. Only three minerals that had a unit value less than \$100 per tonne were also mostly exported. These were: (a) neph-

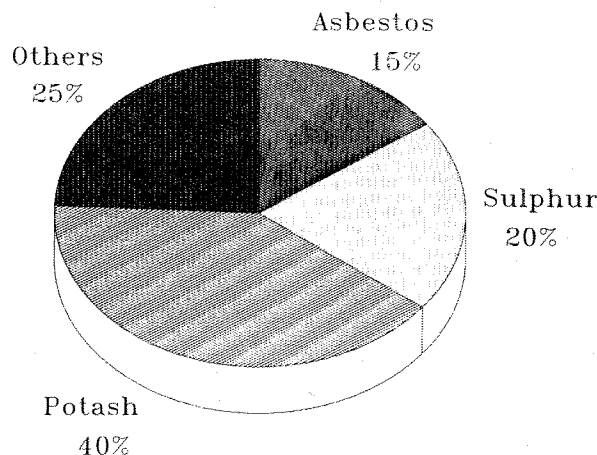

Figure 2. Canadian exports of industrial minerals 1989 - \$2.95 billion.

TABLE 2
IMPORTANCE OF EXPORTS - 1989

Unit value \$/t	Mineral	% shipment to exports
374	Asbestos	97%
134	Potash	99%
123	Peat	76%
120	Fluorspar	100%
107	Sulphur	100%
104	Talc	34%
c	TiO ₂	90%
c	Granite	35%
c	Graphite	100%
80	Sodium sulfate	60%
80	Lime	10%
78	Barite	4%
76	Cement	25%
42	Nepheline syenite	72%
24	Salt	22%
10	Gypsum	70%
6	Crushed stone	<1%
3	Sand & gravel	<1%
c	Silica	5%

eline syenite, for which Canada ranks first as world producer and exporter; (b) gypsum, for which Canada ranks second as world producer and first as exporter, mainly because of Canada's excellent resources and proximity to markets; and (c) sodium sulphate, for which Canada ranks third as world producer and is a major supplier to the U.S. market.

IMPORTANCE OF THE UNITED STATES MARKET FOR CANADIAN INDUSTRIAL MINERALS

The United States is the most important customer of Canadian industrial minerals. Canadian sales in the United States have shown over the last decade a strong stability and a wide diversity of minerals traded. In 1989, Canadian producers exported close to \$1.2 billion worth of industrial minerals to the United States (Figure 3). These exports which accounted for 43 per cent of our total exports of industrial minerals have created strong linkages between Canadian suppliers and U.S. buyers, and also a strong reliance by U.S. firms on our exports in order to meet the needs of consumers in that country.

In assessing the U.S. market, Canadian industrial minerals can be divided into two basic groups (Figure 4). A first group of minerals for which the U.S. accounts for more than 90 per cent of our exports comprises twelve minerals with a total export value of \$325 million in 1989. They are, namely, graphite, fluorspar, granite, barite, sodium sulphate, salt, talc, cement, sand and gravel, crushed stone, gypsum and lime.

This first group of minerals generally shows promising sales opportunities in the U.S. In the last five years, several of these minerals demonstrated strong growth in demand in the U.S. Other minerals in this first group are

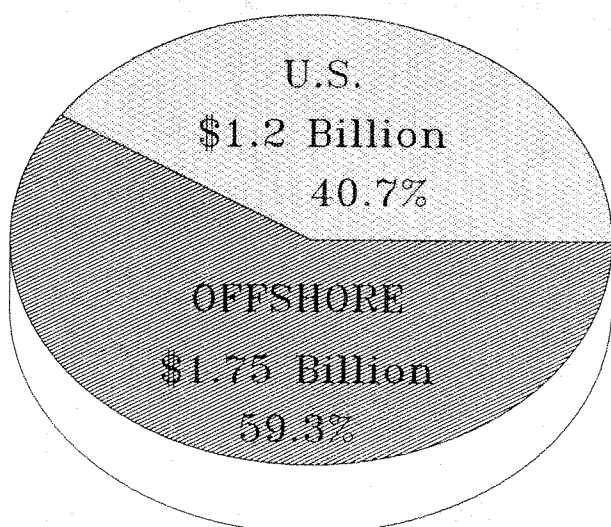

Figure 3. Canadian exports of industrial minerals - 1989 (Total Value - \$2.95 billion).

highly dependent on fluctuations in the U.S. market and therefore their sales are vulnerable to increased domestic production in the U.S., declining domestic consumption in that country or higher imports into the U.S. from countries other than Canada.

A second group comprises peat, titanium dioxide, sulphur, potash and asbestos for which the U.S. accounts for between 10 per cent to 85 per cent of our exports; in 1989, this latter group had a total export value to the U.S. of \$905 million.

The second group of five minerals is less sensitive to prevailing economic conditions in the U.S. Trade in the United States is important for these minerals; however, it is complemented by extensive trade with offshore countries. Moreover, the marketplace for these minerals is more affected by international factors and opportunities in the U.S. for them can be realized in a more global context.

Looking at the first group of minerals in more detail, prospects for future sales of Canadian graphite and acid-grade fluorspar in the United States appear excellent in the short to medium-term. The U.S. industry is highly dependent on imports for graphite and acid-grade fluorspar. The U.S. apparent consumption of these two minerals has shown high growth rates, 67 per cent and 34 per cent, respectively, between 1985 and 1989. The high import reliance of U.S. consumers (above 90%) bodes well for exporters such as Canada; sales opportunities could be realized with market penetration programs; however, the dominance of other countries as major suppliers in the U.S. market offers both opportunities and risks.

Markets for graphite have evolved significantly over the past ten years. Highly sophisticated graphite concentrates are being produced in many locations to respond to ever-increasing demand. Graphite consumption in the United States is expected to grow in the short to long-term due to its increasing usage in a range of industrial sectors; the latter include refractory products and replacement products for asbestos in gaskets. The world market for crystalline graphite is highly competitive and is strongly influenced by China and the Soviet Union.

Opportunities for Canadian sales in the North American market appear very good, provided that increases in supply are not too sudden and allow the market to progressively absorb any significant increase in productive capacity. Apart from representing a very reliable source, Canada produces graphite flakes of great purity. These two factors should allow producers to capture future sales opportunities in the United States. Joint ventures negotiated between Canadian producers and U.S. distributors should also help in capturing future sale opportunities.

The world market for acid-grade fluorspar plummeted in 1990 as a result of international controls on the production and consumption of chlorofluorocarbons (CFCs). The production of acid-spar in Canada stopped in 1990 when the sole Canadian producer in Newfoundland went into receivership. However, the deposit contains significant tonnages of high-quality acid-grade fluorspar ore free from arsenic and phosphorous substances. In the mid to long-term, consumption of fluorspar is expected to increase marginally, mainly due to anticipated growth in the aluminum sector and in substitutes for CFCs. The U.S. market is currently dominated by imports from China, South Africa and Mexico; however, if production in Newfoundland resumes, Canada could potentially gain market-shares in the U.S. because of its high-quality ore and its favourable geographic location.

The demand for dimensional granite products in the United States has continued to grow at an annual rate of 8 to 11 per cent since 1985, while U.S. reliance on imports remained stable at 50 per cent. The Canadian granite industry is expected to fare well in the medium to long-term with prospects of increased penetration of foreign markets. The Canadian industry continues to expand in order to maximize its ability to meet the growing consumption for granite products in the United States. Despite the dominance of Italy as the major exporting country for granite to the U.S., Canadian producers have succeeded in increasing continuously their share of this important market. In this context, four segments of the Canadian granite industry are expected to perform well in the near-term; these include the rough granite and architectural granite sectors, and the sectors of secondary services and peripheral services. In the medium-term,

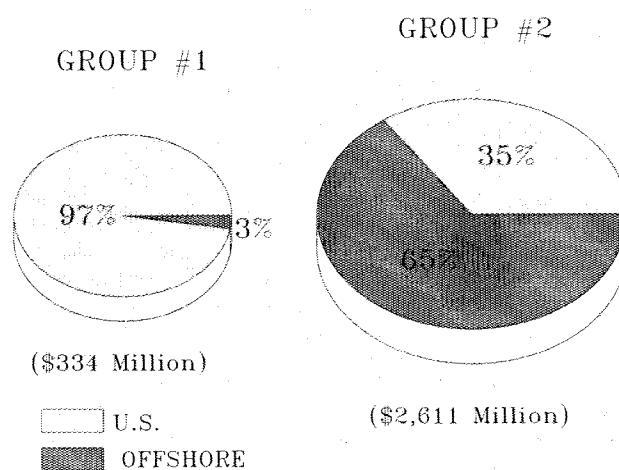

Figure 4. Canada exports - 1989.

growth in granite quarrying and processing is foreseen in the province of Quebec while development activities are currently being carried out in Ontario, Manitoba and British Columbia.

The United States is the predominant destination for Canadian barite despite the very small contribution of these shipments to the U.S. marketplace. During the last five years, total U.S. consumption of barite from all sources varied between 1.2 megatonnes per year and 1.6 megatonnes per year, with oil and gas-well drilling activities accounting for close to 85 per cent of barite consumed in the United States. Most barite products consumed are in ground and crushed forms, mostly transformed locally from imported crude originating from China, India and Mexico. The U.S. industry relies heavily on imported crude barite to meet its requirements. In this respect, Canadian producers can take advantage of selective market niches with some risk. In North America, the demand for barite is forecast to increase as a function of growth in drilling activities across North America. Barite demand for filler and extender applications in plastics and rubber products and in chemical products is expected to continue to grow rapidly.

Consumption of gypsum in the United States increased 7 per cent over the last five years. Demand for gypsum is projected to remain stable in North America as the consumption of wallboard in the construction industry flattens. Canadian exports of crude gypsum to the United States appear secure due to the lower transportation costs and higher quality gypsum of Canadian producers. Importantly, demand for crude natural gypsum is likely to be challenged by the production of synthetic gypsum from flue-gas-desulphurization processes. U.S. reliance on imports of gypsum has shown a continuous decline since 1985 from 40 per cent in 1985 to 32 per cent in 1989, due to increased domestic production and reduced imports. Canadian producers hold a strong position accounting for two-thirds of total imports; however, stiff competition expected from Mexico may influence that situation.

Domestic sales of salt and sodium sulphate in the United States were stable with no major changes in consumption and import reliance. Consumption of talc and cement increased 4 per cent while their respective reliance on imports grew to reach 7 per cent and 17 per cent respectively.

U.S. consumption of sodium sulphate remained static at around 850 000 to 900 000 tonnes per year during the last five years with stable U.S. reliance on imports at 14 per cent. Canada is the leading supplier of sodium sulphate to the U.S., accounting for a 95 per cent share of total imports. The current dominance of Canadian suppliers should position them to increase their sales in the near future. In the United States, sodium sulphate is mostly used in soaps and detergents (45%) and in pulp and paper (30%). Environmental concerns respecting detergents may limit growth in consumption of sodium sulphate despite sales opportunities in the pulp and paper sector as a substitute for caustic soda. Reduced domestic production of sodium sulphate in the United States could trigger higher import shipments from Canada in the near-term.

U.S. consumption of salt has remained stable at 39.2 megatonnes per year in the last three years, while im-

ports continued to increase to reach 6.1 megatonnes in 1989-90. U.S. reliance on imports remained static at 10.5 per cent with Canada holding a strong 40 per cent share of total salt imports. Sales opportunities for Canadian salt depend on market conditions. The high stability that Canada enjoys in this market should limit the impacts from any minor fluctuation in U.S. consumption. Demand for salt is forecast to remain stable in the short- to medium-term due to sustained demand by both the chemical and road de-icing sectors. Environmental concerns are limiting growth of de-icing salt consumption; several substitutes are currently under investigation for utilization in corrosion-prone areas such as bridge decks and underground parking lots. Salt consumption by the chloralkali sector has become more sensitive to the link between chlorine and the presence of dioxins and furans in effluents discharged by pulp mills; however, salt sales should remain stable due to strong demand for caustic soda and sodium chlorate.

Canadian producers of talc and cement benefit from an existing strong position in the United States with a 63 per cent and 28 per cent share, respectively, of total imports. U.S. consumption of talc and cement increased 4 per cent between 1985 and 1989. U.S. reliance on imports of cement remained stable at 17 per cent; the latter coming mainly from Mexico and Canada. The U.S. industry has increased its reliance on talc imports over the last five years, from 4 per cent in 1985 to 9 per cent in 1989. Canada has largely benefitted from these expanded imports with larger shipments to the U.S. of refined talc products. In the near future, Canadian producers of talc and cement could experience more competition in the United States from U. S. producers due to increasing domestic production.

Domestic demand in the United States for construction materials such as crushed stone and sand and gravel increased significantly during the 1980s, with growth ranging between 12 per cent and 20 per cent. Reliance within the U.S. on imports remained small (less than 1%) as domestic sources responded to most of this increase in demand. Canadian lime exports to the U.S. have been maintained in this period and enjoy a sustained 74 per cent share of total U.S. lime imports. U.S. reliance on Canadian suppliers for imports of crushed stone and sand and gravel is around 86 per cent and 52 per cent, respectively. Although the significance of Canadian exports of these construction materials is marginal compared with its production (less than 1 per cent of Canadian production is exported), U.S. consumption for these materials is growing and buyers are likely to face shortages, leaving room for opportunities in imports from all sources. Canadian producers are already positioning themselves to capture these potential sales.

Consumption of aggregates is forecast to increase; however, production of these materials is becoming more sensitive to environmental factors. The exhaustion of reserves near urban areas will lead to the exploitation of sources that are more remote, resulting in increased transportation costs. The utilization of some deposits will also be limited by environmental regulations on noise, dust and water contaminants. Within the next few years, aggregate producers in Newfoundland, Nova Scotia and British Columbia could benefit from a firming North American market, with growing prospects for coastal

shipments to urban regions along the U.S. eastern seaboard and west coast.

Let's now look at the second group of minerals in more detail. Since 1989, the Canadian peat industry has been going through a period of consolidation. In the medium-term, the situation depends on continuing growth in offshore sales and on the success of promotional activities carried out by the Canadian Sphagnum Peat Moss Association in the United States. The main objective of this campaign, which is aimed at the retail level, is to improve awareness by American buyers of the benefits of using Canadian sphagnum peat moss in gardening activities. The demand for peat in the United States has grown 8 to 11 per cent in the last five years, while the contribution of imports to the U.S. consumption remained stable at 33 per cent. Canadian peat exporters are well positioned in this marketplace, accounting for more than 99 per cent of total U.S. peat imports. Prospects for growth in Canadian sales of sphagnum peat moss in the U.S. are excellent but will be limited by competition from lower-cost products such as bark and straw. Future opportunities for Canadian producers reside also in offshore markets, with Japan as the main prospect. This market has been developed by Canadian suppliers over the last six years and has demonstrated a three-fold expansion in this period. Canada remains the leading foreign supplier of peat to Japan with a 95 per cent market share. Peat products as well as value-added peat-based products are expected to make further in-roads in Pacific Rim markets. Sales opportunities have been growing in South Korea and Oceania.

Over the last five years, the U.S. consumption of titanium dioxide has fluctuated between 900 000 tonnes per year and 1 000 000 tonnes per year while imports into the U.S. have been declining due to higher domestic production. Since 1989, the United States has become a net exporter of titanium dioxide pigment. Canada's share of imports is estimated at 16 per cent, after Germany with a 20 per cent share. Stiff competition amongst foreign suppliers may hinder Canadian producers from increasing their presence in this lucrative market. The production of Canadian titanium dioxide pigment is forecast to decline in the short-term following the closure of one of the two sulphate route plants in Canada. In the long-term, two main factors may affect the Canadian supply of titanium dioxide pigment. These are the feasibility of producing a slag compatible with the chloride process and the commissioning of a new chloride route plant within the next five years.

U.S. consumption of sulphur has risen 6 per cent since 1985. The United States imports close to 2.2 megatonnes per year of sulphur; Canada supplies about 50 per cent of this. In the last five years, U.S. reliance on imports varied from 7 per cent to 16 per cent in response to domestic requirements and international market conditions for fertilizers. Close to 60 per cent of all sulphur consumed in the U.S. is used in the manufacture of fertilizers. Canada and Mexico are the leading exporters of sulphur in the United States. The importance of the U.S. as an export destination for Canadian sulphur has increased in the last three years from 17 per cent to close to 25 per cent of total Canadian exports. Canadian exporters have achieved better netbacks from North American sales compared to those offshore due to strong U.S. demand and depressing world market condi-

tions. Canadian suppliers are expected to continue to make in-roads in the important U.S. market.

In the last ten years, the consumption of potash in the United States has been fluctuating between 5 megatonnes per year and 6 megatonnes per year K_2O . However, U.S. reliance on imports remained quite stable at 80 per cent in this period, with Canadian exporters enjoying a 90 per cent share of total U.S. imports. Canadian producers are likely to maintain their position in the North American market and take advantage of growth in the domestic demand within the United States for potash. U.S. consumption of asbestos has dropped dramatically over the last five years, from 120 000 tonnes in 1985 to 55 000 tonnes in 1989. U.S. domestic consumption is mostly supplied by imports. Canada was the leading supplier with 95 per cent of total U.S. imports, followed by the Republic of South Africa (4%).

U.S. demand for asbestos will continue to decline following the legislated phase-out of asbestos in the United States that came into effect in 1989.

CANADA-U.S. TRADE RELATIONS IN INDUSTRIAL MINERALS

Over the last 20 years, a number of developments have occurred with respect to Canada-U.S. trade relations in industrial minerals. During this period, Canadian suppliers of industrial minerals faced three anti-dumping petitions from U.S. producers. These were, namely, sulphur in 1973, salt in 1985 and potash in 1987. These actions precipitated a short-lived reduced level of exports in sulphur in the early 70s and for salt in the mid-80s, and higher delivered potash prices in the 90s. Technical barriers have also developed restricting sales growth for some Canadian minerals. In 1982, cement imports into the U.S. became limited under a "Buy America" clause within the U.S. Surface Transportation Assistance Act (STAA). The STAA provided substantial funding for highway and bridge projects in the U.S., which represented about 6 per cent of total cement consumption; in 1984, these restrictions were lifted by the Congress. In 1983, the U.S. Environmental Protection Agency (EPA) initiated proposals to ban asbestos in some products consumed in the United States. In 1989, EPA established a final ban and phase-out on the use of asbestos and asbestos products in the USA over the next 7 years. This ruling is currently in litigation in U.S. courts; a determination is expected by mid-1991. However, the adoption of the Canada-U.S. Free Trade Agreement led to a five to ten year phase-out as of January 1989 of tariffs on many items, including several minerals. While most industrial minerals produced in Canada already benefitted from "in-franchise" (free) U.S. tariffs, some minerals were given special access to the U.S. market after the implementation of that agreement in 1989 (Table 3). Tariffs were reduced for talc, acid-grade fluorspar, titanium dioxide and sodium sulphate and were eliminated for cement, graphite, cut granite and barite. Some modifications in these tariffs, even small levies, have improved the ability of the Canadian industry to realize new market opportunities in the U.S. Specifically, the Agreement has positioned some Canadian producers and exporters on an equal footing in the U.S. market with Third World exporters who enjoy duty-free access under the US General Preferential System.

CONTRIBUTION OF CANADIAN INDUSTRIAL MINERAL EXPORTS TO OFFSHORE MARKETS

In 1989, the value of Canadian industrial mineral exports to offshore markets was estimated at \$1.725 billion or 58 per cent of total value of Canadian industrial minerals exports (Figure 5). Canada exported more than twenty industrial minerals to more than forty countries in that year; however, only five minerals accounted for 99 per cent of these offshore exports. These were, namely, potash, sulphur, titanium dioxide, asbestos and peat. The importance of Canada as a major supplier in world markets can be best seen by its contribution in the international scene; Canada ranks as the world's leading exporter of potash (39% world share in 1989), sulphur (34%), asbestos (41%) and second major exporter for

TABLE 3
IMPACT OF CANADA - U.S. FREE TRADE AGREEMENT ON SELECTED I.M.

	Impact to Canadian producers	U.S. tariff 1989
Cement	Free	0 - 22 c/t
Graphite	Free	0.7 c/kg
Barite	Free	1.25 - 3.20 \$/t
Cut granite	Free	4.2% ad valorem
Fluorspar	Free	2.07 \$/t
Talc	Reduced 1993	0.02 c/t - 2.4% a.v.
TiO ₂	Reduced 1993	6% ad valorem
Sod. sulfate	Reduced 1998	32.5 c/t

titanium dioxide (23%) and peat (21%) (Table 4).

Offshore exports of industrial minerals benefit several provinces in Canada (Table 5). For example, offshore sales of potash benefit Saskatchewan (84% of Canadian production) and New Brunswick (16%); sulphur in Alberta (90%) and British Columbia (7%); asbestos in Quebec (75%), British Columbia (16%) and Newfoundland (9%); titanium dioxide in Quebec (100%); and peat in Quebec (41%), New Brunswick (31%) and Alberta (11%). Western Canada is well positioned to supply world markets as it dominates potash and sulphur sales and holds a strong position in asbestos and peat sales.

The Asian market is the most important destination for these five Canadian industrial minerals accounting for a 42 per cent share of our total offshore sales. Western Europe accounts for 23 per cent, followed by Latin America (14%), Africa (8%), Oceania (7%), the Middle East (4%) and Eastern Europe (2%) (Figure 6). In Asia, Canadian sales are dominated by shipments of potash, asbestos and sulphur. In Western Europe, most shipments are of titanium dioxide and asbestos while in Latin America, Canada's sulphur and potash are primary exports. In Africa, Oceania and Eastern Europe sulphur sales dominate, followed by shipments of potash. In the Middle east, asbestos and sulphur account for mostly all Canadian sales of industrial minerals.

Three Canadian industrial minerals, i.e. sulphur,

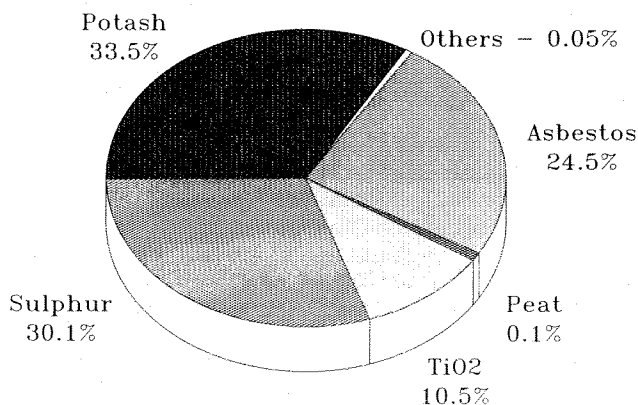

Figure 5. Offshore sales - \$1.715 billion (1989).

potash and asbestos, are strongly export-oriented; their production levels in Canada are heavily affected by international market conditions. In the case of sulphur and potash, Canadian producers are mostly perceived as swing or residual suppliers due to their ability to apply controls on production and inventories.

Close to ninety percent of Canada's sulphur production is exported. The world sulphur market is currently stagnant but should regain some firmness in the second half of this year. However, a surplus situation is expected by 1993 as new productive capacities come on stream in Canada, the United States and the U.S.S.R. Canadian production of elemental sulphur is forecast to increase from 6.2 megatonnes per year in 1991 to 7.1 megatonnes per year in 1995. The huge sulphur inventories located in Alberta have been continuously declining since 1979 when tonnages exceeded 20 megatonnes; late in 1990, sulphur stocks were estimated at 3.6 megatonnes and may reach 2.5 megatonnes by the end of 1991. Several projects in Canada are expected to be commissioned during the next five years. Of special significance, the Caroline project initiated by Shell Canada Limited in Alberta is expected to start in 1993 and produce 1.4 megatonnes of sulphur, accounting for two-thirds of new incremental production in Canada by 1994. Other projects include expansions at Kaybob, Brazeau and Savannah Creek in Alberta, and at Taylor Flats and Pine River in British Columbia. World sulphur consumption is forecast to grow at an annual rate of 1.3 per cent between

TABLE 4
CANADA AS A WORLD PRODUCER AND EXPORTER OF GROUP #2 MINERALS - 1989

	Producer Rank	Exporter	
		Rank	Share
Peat	4	2	21%
TiO ₂	2	2	23%
Sulphur	3	1	34%
Potash	2	1	39%
Asbestos	2	1	39%

1990 and 2000. Higher growth rates are projected in Asia, Africa and the United States during this period.

In international trade, Canada is currently the major sulphur supplier in the Middle East (100%) and Oceania (97%); while maintaining a dominant presence in Latin America (60%), Africa (50%) and Asia (50%). Poland dominates in Western Europe (37%) and Eastern Europe (81%), but Canada is ranked as second sulphur supplier to these regions holding a 7 per cent and 18 per cent share respectively.

The Canadian potash industry is concentrated in Saskatchewan and in New Brunswick with a total productive capacity estimated at 11.8 megatonnes per year K₂O. Canada ranks as the second world producer of potash; production in 1989 amounted to 7.0 megatonnes K₂O and inventories were at 1.3 megatonnes K₂O. Current world market conditions are flat; however, some supply shortfalls may prevail in 1991 as a result of lower output from Germany-east and the Soviet Union. The 1991 Canadian potash production is forecast to increase 10 per cent over last year, to reach 7.7 megatonnes K₂O. The world potash market is still experiencing an oversupply situation and Canada continues to act as a swing residual supplier by maintaining a low rate of capacity utilization. In 1989, Canadian producers ran at 59 per cent of capacity compared to a world average of 80 per cent. The industry in New Brunswick operated at 81 per cent of capacity compared to Saskatchewan producers at 52 per cent. For the next ten years, world consumption of potash, which is estimated at 28 megatonnes per year K₂O in 1989, is forecast to increase at annual growth rates ranging between 1.6 per cent and 2.0 per cent. Potash consumption in developing countries in Asia and Latin America will experience higher growth rates, i.e. 3 to 7 per cent per year, while demand in developed countries is projected to remain flat. Over the next ten years, exhausted reserves in the United States, Spain, France, Germany and the Soviet Union will have to be replaced in order to meet world demand, generated by expanding world population and higher potash formulation in fertilizer mixes. New incremental production may likely come on stream firstly from higher capacity utilization in Saskatchewan, and secondly from new mines. Possible new mines exist in Canada, especially in Saskatchewan, Manitoba and New Brunswick.

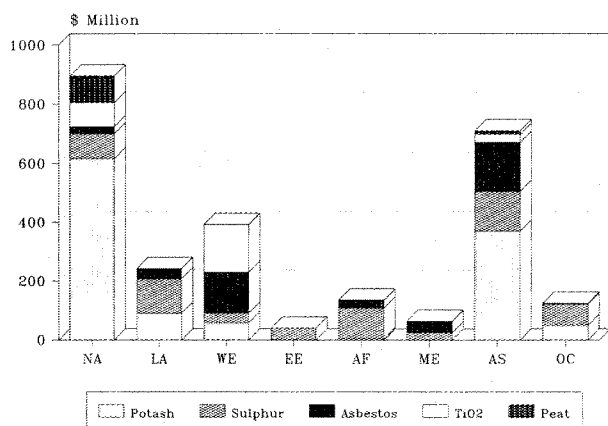

Figure 6. Canadian exports for Group #2 commodities.

TABLE 5
MAJOR PRODUCING REGIONS IN CANADA FOR
GROUP #2 COMMODITIES (1989)

Potash	Sask	84%	NB	16%	--	--
Sulphur	Alta	90%	BC	7%	Ont	1%
Asbestos	Que	75%	BC	16%	Nfld	9%
TiO ₂	Que	100%	--	--	--	--
Peat	Que	41%	NB	31%	Alta	11%

In international potash trade, Canada holds a strong position in Oceania (92% of total imports) and Asia (42%). Latin America is supplied by Canada (28%, leading supplier), Germany (27%) and the USA (20%). Canada maintains a small contribution in Western Europe (8%) and Africa (10%) where trade is dominated respectively by Germany and Israel.

Canada supplies half of the asbestos imports of Asia and Western Europe. Together these regions account for three-quarters of our total offshore sales of asbestos. In the short-term, the world demand for asbestos appears strong due to firm sales for asbestos products such as asbestos cement pipes. Medium-term prospects for asbestos sales appear good in developing countries and in Europe, but these could be influenced by the outcome of the EPA ban announced in 1989 and for which a ruling is expected by mid-1991. In this respect, a stable regulatory environment is critical to the long-term future of the asbestos industry. In the late 1980s, the world market returned to stability and growth following depressing years in the 70s. The Asian market is expected to demonstrate a strong growth, especially in Japan. Markets in Latin America, Africa and the Middle East are forecast to continue at current level of consumption or experience marginal growth. Consumption in the United States and Germany is expected to decline; currently these countries represent a small share of Canadian sales into world markets. At the international level, Asia is the leading offshore destination for Canadian asbestos with a 40 per cent share of offshore sales. Canada benefits from a strong position in this market accounting for two-thirds of Asian imports of asbestos in 1989.

The outlook for sulphur, potash and asbestos appears quite favourable for the economies of Western Canadian provinces. By the end of the 1990s, sulphur and potash world markets will have expanded with the potential of securing Canada a predominant world exporter. In conclusion, Canada enters the next millennium with a potential to increase its contribution to world trade of industrial minerals. Canada will likely continue to benefit from its huge resources and large variety of industrial minerals and to further develop its exports capabilities both in terms of security of supply and of reliable logistics.

INDUSTRIAL MINERALS IN ALBERTA

By Wylie N. Hamilton

*Alberta Geological Survey, Alberta Research Council,
Edmonton, Alberta*

INTRODUCTION

A rich variety of industrial minerals is found in Alberta, including 13 commodities that are currently produced and another dozen or so with potential for future production (Figure 1). However, the bulk of the current production value comes from four commodities - sulphur, limestone (in cement and lime), sand and gravel, and salt. These four accounted for 95 per cent of the province's total industrial minerals production value of \$618 million in 1990 (Figure 2). Alberta ranks fourth among the Canadian provinces in industrial minerals production, with about 12 per cent of the total for Canada.

Alberta's industrial minerals are primarily of sedimentary origin, derived from Phanerozoic rocks of the Western Canada Sedimentary Basin. The rocks form a northeast-tapering wedge of strata that terminates against crystalline basement rocks of the Precambrian Shield, exposed in the northeast corner of the province (Figure 3). The strata extend across the Plains region with a gentle southwestward dip, becoming upthrust and deformed along the Rocky Mountains fold belt in the southwest. Basin sediments include Paleozoic carbonates and evaporates, and Mesozoic and Tertiary clastics, many of which are existing or potential sources of industrial minerals. Glacial sediments that mantle much of the Alberta landscape, and the exposed crystalline rocks in the northeast are also sources of some of the industrial minerals.

Information on known deposits of the industrial minerals is summarized in the following sections, presented in alphabetical order by commodity. Minerals that have been dealt with in previous published summaries (Hamilton, 1976, 1984) are discussed only briefly. Those for which new information has been obtained are described in greater length. Locations of producing operations and prospective deposits are shown in Figures 3 to 7.

BENTONITE

Bentonite is common in Upper Cretaceous and Paleocene sediments throughout the Plains region; however, economic deposits are rare (Scafe, 1975). Only one deposit currently is being quarried, by M-I Drilling Fluids Inc. along the Battle River southeast of Edmonton (Figure 3). Production is of both swelling and non-swelling types, and serves a variety of markets - drilling mud, binder in animal feed pellets, in foundry sand, as a sealant for lining of tailings ponds, etc. Total annual production is estimated to be in the range of 10 000 to 15 000 tonnes.

Other known bentonite deposits in Alberta have indicated little potential for development, due to low yields or high grit content. However, given the extensive distribution of bentonitic strata, discoveries of additional

deposits in the shallow bedrock that have gone undetected to date are considered likely.

CLAY AND SHALE

Clays and shales are the dominant rock types in virtually all the Mesozoic formations and surficial deposits in Alberta. The clay rocks have been widely exploited at various times in the past for structural clay products, cement, and lightweight (expanded clay) aggregate manufacture. Although Alberta's clay resources are vast, as ceramic materials they are mostly the low-grade type, suitable only for low value ware such as brick (Scafe, 1991). Intermediate-grade stoneware clay and fireclay are known to occur in a few deposits, but high-grade ball and china clays are unknown.

In general, the better grades of ceramic clay in Alberta are found in nonmarine bedrock formations, among which the Upper Cretaceous Whitemud Formation has been the principal source (Hamilton and Babet, 1975). The Whitemud is exposed in the Cypress Hills area of southeastern Alberta, where several quarry operations currently exist. The clays are used mainly for structural clay products manufacture in plants at Medicine Hat and Redcliff, operated by I-XL Industries Ltd. Although the Whitemud is host to large kaolin deposits in Saskatchewan (Guliov, this volume), its potential for kaolin in Alberta is lacking (Hamilton, *et al.*, 1988).

Other Upper Cretaceous clays are quarried at several localities for use in cement making. Sources include the Paskapoo Formation - quarried at Wabamum (60 km west of Edmonton), and the Battle Formation - quarried in the Cypress Hills area. These clays are used along with local glacial clay in the cement plant at Edmonton operated by Inland Cement Ltd. Shales from the Wapiabi and Belly River Formations are quarried for use in the cement plant at Exshaw operated by Lafarge Canada Inc. Shale from the Paleocene Porcupine Hills Formation is used by Consolidated Concrete Ltd. for lightweight aggregate manufacture in Calgary, from pits at DeWinton just south of the city. Glacial lake clays are used by I-XL Industries Ltd. for a brick plant at Edmonton, from deposits quarried at the plant site and near the town of Athabasca (Figure 3). Other significant past uses of Alberta clay rocks included glacial clays for expanded aggregate at Edmonton and Namao (Figure 3), and dolomitic shale from the Mississippian Banff Formation for mineral wool production near Exshaw (Fox, 1981).

Production values for ceramic clay products and lightweight aggregate manufacture are not reported for Alberta. Neither are the quarried tonnages of raw clay and shale.

FORMATION BRINES

Subsurface formation waters in Alberta range in composition from almost fresh to brines with total dissolved solids content many times that of seawater. Cer-

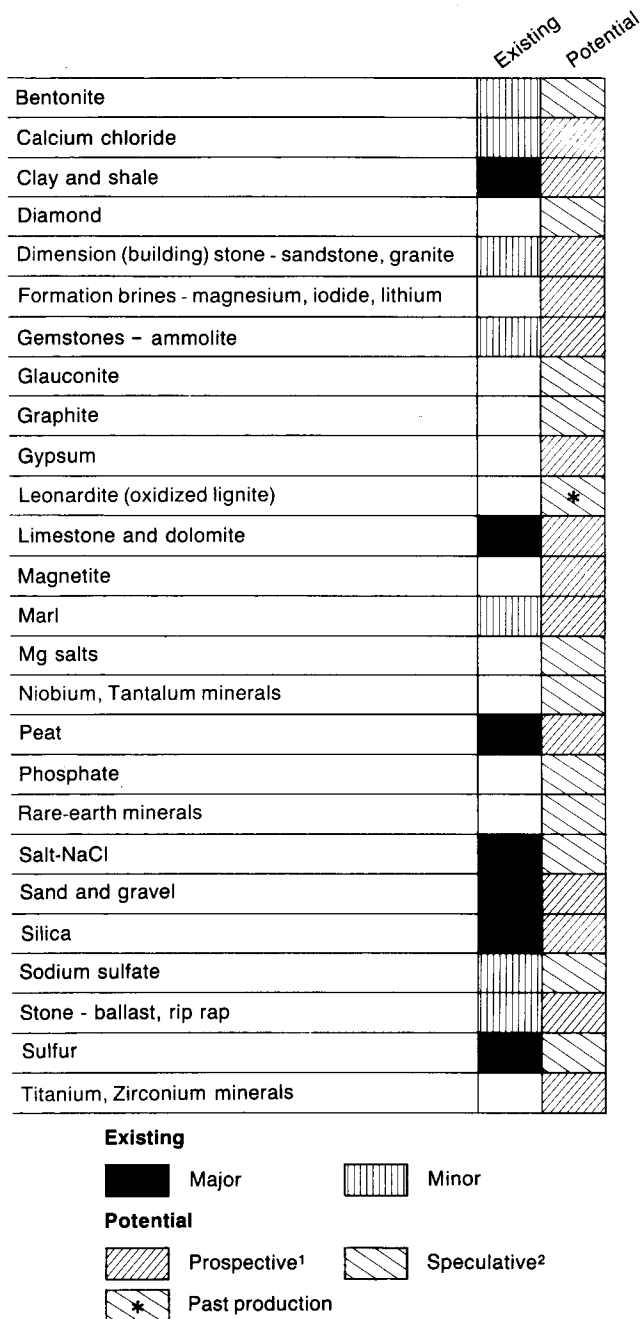

¹ Deposits reasonably well documented; sufficient prospecting to establish presence of ore-grade or potentially ore-grade material; indications of significant size based on geological projections and/or drilling; favourable industrial market potential.

² Deposits/showings of material known but not well documented; existence predicated largely on favourable geological situation; indications of potentially significant size; favourable industrial market potential for the present or near future.

Alternatively, some deposits with existing production may have unfavourable market potential for expansion.

Figure 1. Industrial minerals with existing and potential production in Alberta.

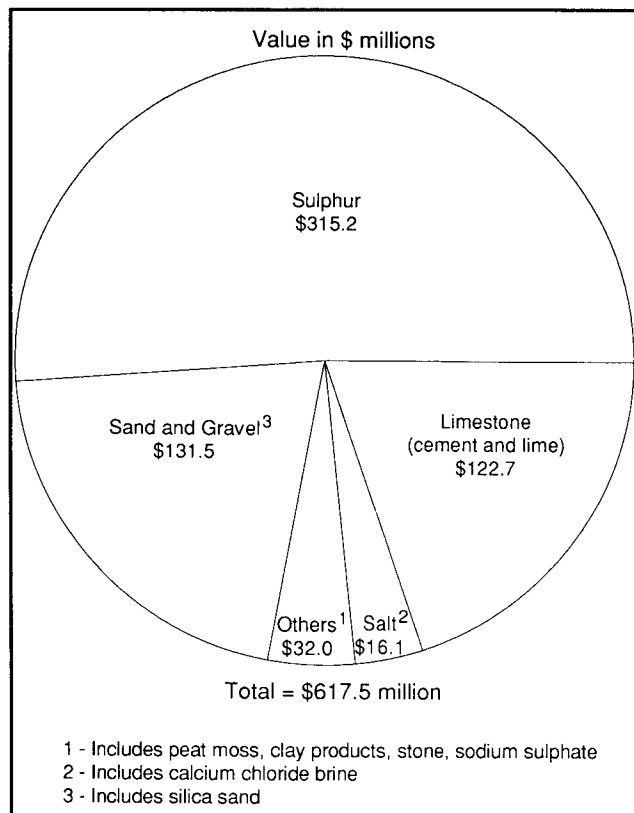

Figure 2. Values of industrial minerals production in Alberta in 1990. Not included are values for bentonite, marl and gemstone.

tain formation brines are enriched in calcium, magnesium, bromide, iodide and lithium (Hitchon, 1984) and constitute potential commercial sources for a broad range of industrial chemicals.

Ca-Mg brine fields with brine compositions exceeding 60 000 milligrams per litre calcium and 9 000 milligrams per litre magnesium have been mapped (Hitchon and Holter, 1971) and cover extensive areas in southern and north-central Alberta (Figure 4). The brines occur in the Upper Devonian Beaverhill Lake Formation in the southern area and the Middle Devonian Elk Point Group in the north-central area. A calcium chloride brine product is produced commercially from both areas, at four localities. Two of the localities, at Drumheller and Brooks, are operated by General Chemicals Ltd., producing from the Beaverhill Lake. The other two are near Slave Lake, operated by Tiger Chemicals Ltd. and Ward Chemicals Ltd. respectively, producing from the Elk Point. No production of magnesium brines presently occurs, although Mg concentrations in some of the brines being produced may be well within the range of potential commercial interest (9 000 mg/l). Given the enormous extent of the Ca-Mg brine fields, the potential for recovery of these chemicals clearly is very large, limited only by the reservoir producibility of the host formations.

Ca-Mg brines generally are also enriched in bromide; however, the highest bromide content measured (2790 mg/l - Hitchon, *et al.*, 1977) is below the level of current commercial sources. It seems unlikely that bromide would be recovered economically from Alberta formation brines, except possibly as a by-product during

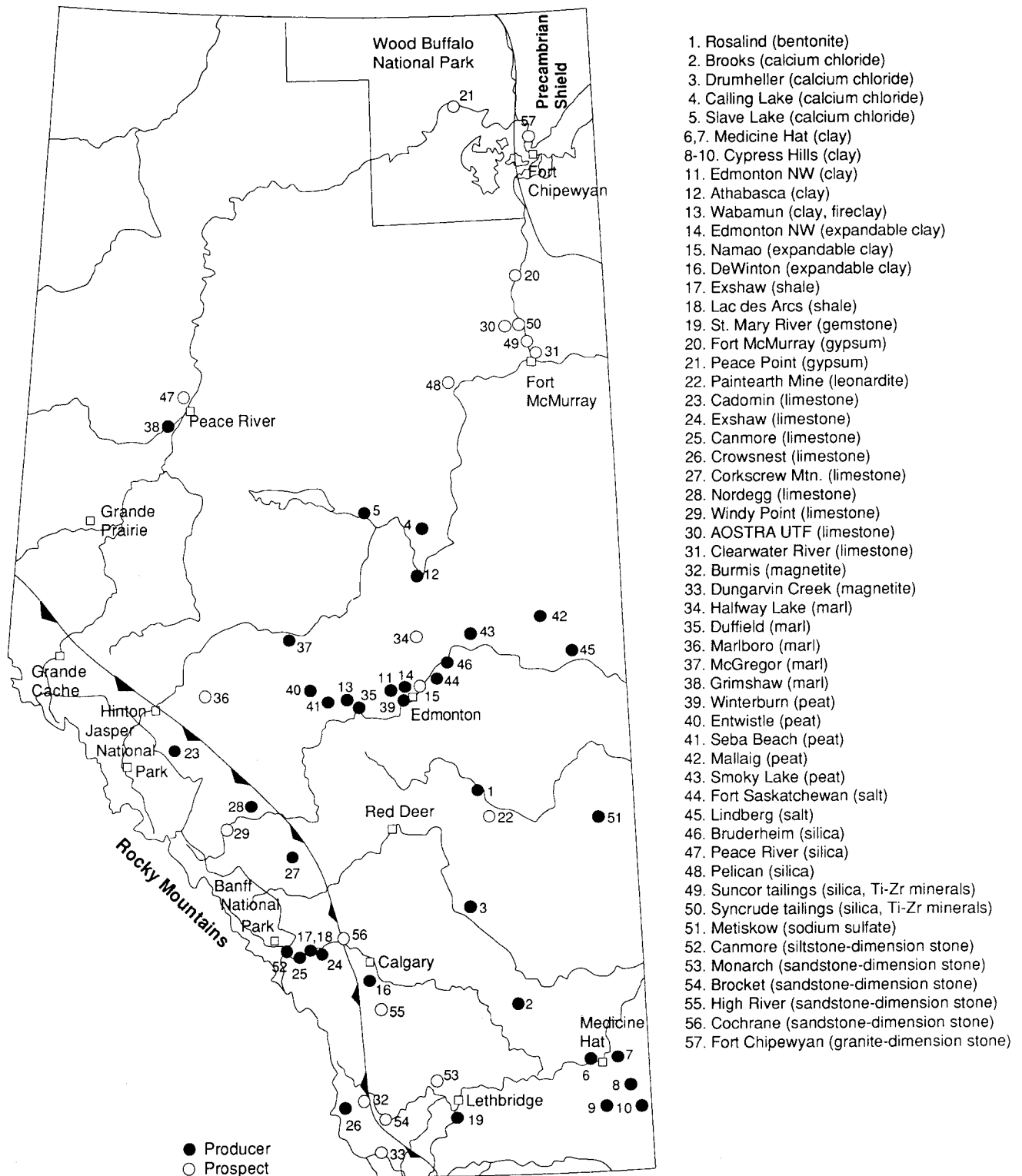

Figure 3. Locations of industrial mineral producers and selected prospects in Alberta.

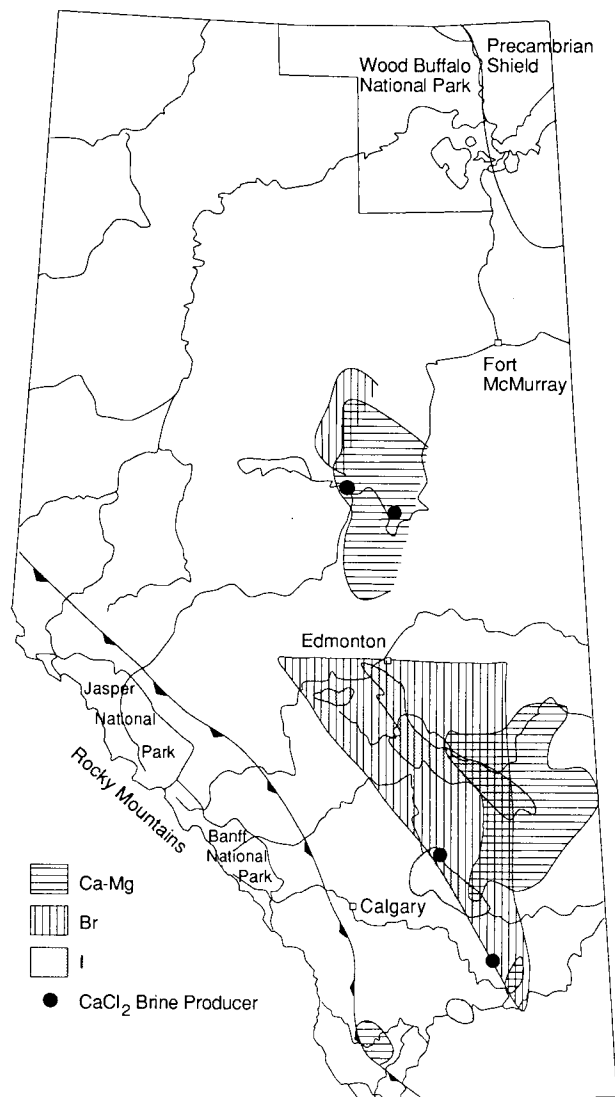

Figure 4. Distribution of formation brines in Alberta with more than 60 000 mg/l calcium and 9 000 mg/l magnesium; more than 1000 mg/l bromide; more than 40 mg/l iodide (from Hitchon, 1971; Hitchon, *et al.*, 1977).

Ca-Mg recoveries (Hitchon, 1984). Brines with iodide enrichment appear to be distinct and separate from the Ca-Mg brines, confined mainly to the shallower formations of Cretaceous age. Contents are generally in the range of 40 to 50 milligrams per litre, which is below the lower limit of current commercial production.

Lithium has had scant attention as a potential Alberta brine product. Few analyses are available, the only published data showing a maximum content of 100 milligrams per litre (Hitchon, *et al.*, 1977), well below the 200 to 250 milligrams per litre level for commercial production in Nevada (Hamilton and Hora, 1987).

GEMSTONES

Gemstones are not common in the rocks of Alberta. Nevertheless, a significant industry exists in the province based on production of ammolite, a gem-quality material extracted from the shell of ammonite fossils (specifically,

Placenticas). Production is from a richly fossiliferous zone in the Upper Cretaceous Bearpaw Formation, where it crops out along the St. Mary River in southern Alberta (Figure 3). The producing company is Korite Minerals Ltd. (Vandervelde, this volume).

LIMESTONE AND DOLOMITE

Limestones occur abundantly in Alberta in two main regions - the Rocky Mountains belt in the southwest and the Fort McMurray region in the northeast (Figure 5). In the southwest, huge reserves of high calcium limestone occur in formations of Cambrian, Devonian and Mississippian ages, exposed more or less continuously along the mountain ranges in narrow outcrop bands (Holter, 1976). The formations exceed 3 500 metres in total thickness in some areas and consist dominantly of limestones and dolomites in about equal proportions. Limestones in the northeast occur in nearly flat-lying Devonian strata onlapping the Precambrian Shield. These limestones have limited exposure in the valleys of major rivers where Cretaceous cover is eroded.

Limestone is exploited currently at six localities in the mountains. The two largest quarries are at Cadomin and Exshaw (Figures 3, 5), both producing limestone from the Devonian Palliser Formation for use in cement making. At Cadomin, Inland Cement Ltd. quarries up to 900 000 tonnes annually for in its cement plant at Edmonton, hauling the limestone by unit train a distance of 300 kilometres. At Exshaw in the Bow Valley, Lafarge Canada Inc. quarries about the same amount for its cement plant on the site.

Two other large operations quarry limestone mainly for lime manufacture, both producing from the Mississippian Livingstone Formation. Again in the Bow Valley, a quarry is operated by Continental Lime Ltd. for its lime plant at Kananaskis, just east of the Exshaw cement plant.

In the Crowsnest Pass, Summit Lime Works Ltd. supplies its lime plant at Crowsnest Lake from quarries near the plant site. These two operations quarry up to 750 000 tonnes annually, about half of which is shipped as limestone rock for various uses.

Two smaller operations, at Nordegg and near Rocky Mountain House, also quarry limestone from the Livingstone Formation for a broad range agricultural and industrial limestone products. At Nordegg, Nordegg Lime Ltd. produces riprap and crushed limestone for general aggregate use. At Corkscrew Mountain, south of Rocky Mountain House, Limeco Products Ltd. quarries and processes limestone for a variety of agricultural products. Annual quarry production at these two operations is about 150 000 tonnes.

Limestones in the northeast region have had no exploitation as yet. Some good grades are reported, but quarriable reserves are limited (Hamilton and Mellon, 1973). Potential for underground mining of limestone may exist at an underground test facility for in situ bitumen recovery from the Athabasca oil sands. Part of the testing operations involve tunnelling in Devonian limestone underlying the Cretaceous oil sands. The limestones at this site show promising grades (Holter and Hamilton, 1989), although a thorough evaluation has not been made.

Dolomite resources in Alberta are vast, but have had

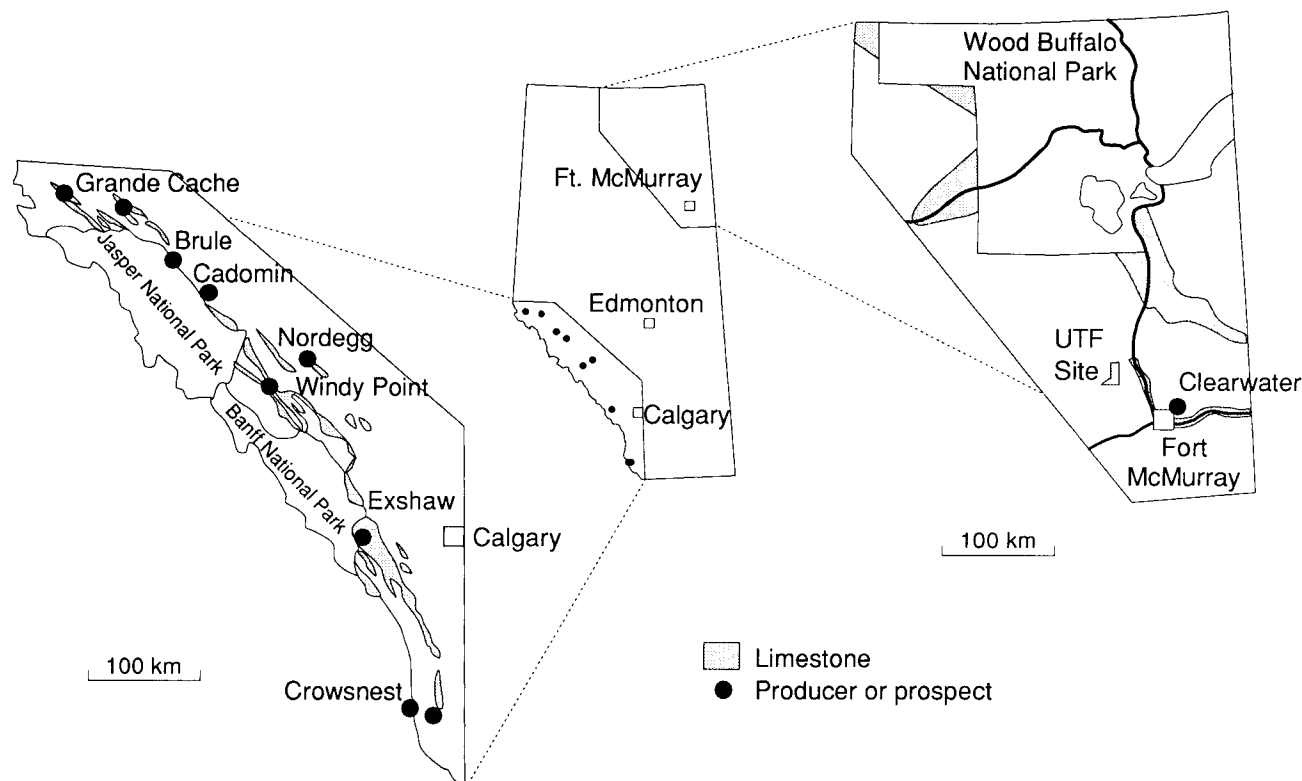

Figure 5. Distribution of limestone outcrop areas and producing or prospective sites in Alberta (from Holter, 1976).

little exploitation. Small past production has been reported from the Devonian Fairholme and Mississippian Rundle Groups in the Crowsnest Pass, for use as flux stone in British Columbia smelters.

Potential for expanded development of Alberta's limestone resources lies in the use of limestone as source rock for precipitated calcium carbonate (PCC), for use as paper filler. Several undeveloped deposits have tested favourably for PCC use (Hamilton, 1987; Holter and Hamilton, 1989; Tower, *et al.*, 1991). Alberta limestone quarried for the Continental Lime plant at Kananaskis is in fact used for PCC production at a pulp mill in Saskatchewan.

MARL AND TUFA

Deposits of marl and tufa are numerous in central and northwestern Alberta (Macdonald, 1982). The deposits are generally small, of postglacial or Recent age, and associated with groundwater discharge areas. A few have sizeable reserves (1 million tonnes or more) with grades of 65% CaCO₃ or better. Two of these, at Halfway Lake about 60 kilometres north of Edmonton, and at Marlboro about 200 kilometres west of Edmonton, were exploited in the past for cement-making; both operations have been shut down for several years. At least three other deposits have had sporadic production for local agricultural liming in Alberta (Figure 3). This appears to be the best potential use for Alberta marls in the future.

PEAT MOSS

Peatlands are widespread through the northern two-thirds of Alberta, covering one-quarter to one-third of

the land surface in this region (Turchenek and Pigot, 1988). Peat moss is commercially harvested at several localities in the province (Figure 3), the largest production coming from a plant near Entwistle, 80 kilometres west of Edmonton. Production for the province in 1990 was 64 000 tonnes, valued at \$13 million. These figures apply only to product that is processed and bailed, largely for export marketing. Peat moss is also produced in unprocessed bulk form for local horticultural use.

SALT

Salt deposits exist extensively in the subsurface of Alberta (Hamilton, 1982), underlying almost half the province as shown in Figure 6. The major deposits belong to the Middle Devonian Elk Point Group, a succession of strata comprised dominantly of thick salt beds which have a maximum thickness of 430 metres in east-central Alberta. The salt beds extend southwestward across the province from minimum depths of 210 metres at Fort McMurray to 1820 metres at Edmonton. Two distinct types of salt deposits are found at the Elk Point Group, corresponding with well defined Upper and Lower subdivisions. The Upper Elk Point contains by far the most extensive deposit, the Prairie Evaporite salt, underlying much of eastern Alberta and extending across southern Saskatchewan, where it contains rich potash mineralization (Figure 6). The deposit varies considerably in salt quality from place to place, in a manner reflecting normal marine evaporite deposition.

The Lower Elk Point salts are more restricted in distribution, although very thick and extensive in east-central Alberta. They occur in three separate deposits, which differ from the Prairie Evaporite in that they are

not normal marine evaporites in their chemical/mineralogical make-up; rather, they reflect a complex history of solution and redeposition that has resulted in salt (halite) of extraordinary purity.

Salt deposits are exploited at a number of localities in the province (Figures 3, 6). At Fort Saskatchewan just east of Edmonton, Lower Elk Point salt is brined from beds at depths of 1860 metres by Dow Chemical Canada Inc. for the manufacture of chloralkali chemicals. At Lindbergh, 80 kilometres east of Edmonton, the Canadian Salt Company Ltd. produces salt for domestic and industrial use, brining from the Upper Elk Point beds at depths of 1100 metres. Salt production for the past several years has been about 1.4 million tonnes annually, most of it for chemicals manufacture.

Two new plants are currently under construction in the area northeast of Edmonton, for production of sodium chlorate to be used in pulp bleaching. Both plants will utilize the exceptionally pure Lower Elk Point salt in solution mining operations. Elk Point salts are also used at several localities in Alberta for underground storage of petroleum products, in artificial caverns (Figure 6).

Past production of salt has occurred from the Lower Elk Point at Duvernay (60 km east of Edmonton) and from the Upper Elk Point at Fort McMurray, both solution mining operations. The latter is the only area in Alberta where salt beds would be shallow enough (210 m) for underground mining of salt.

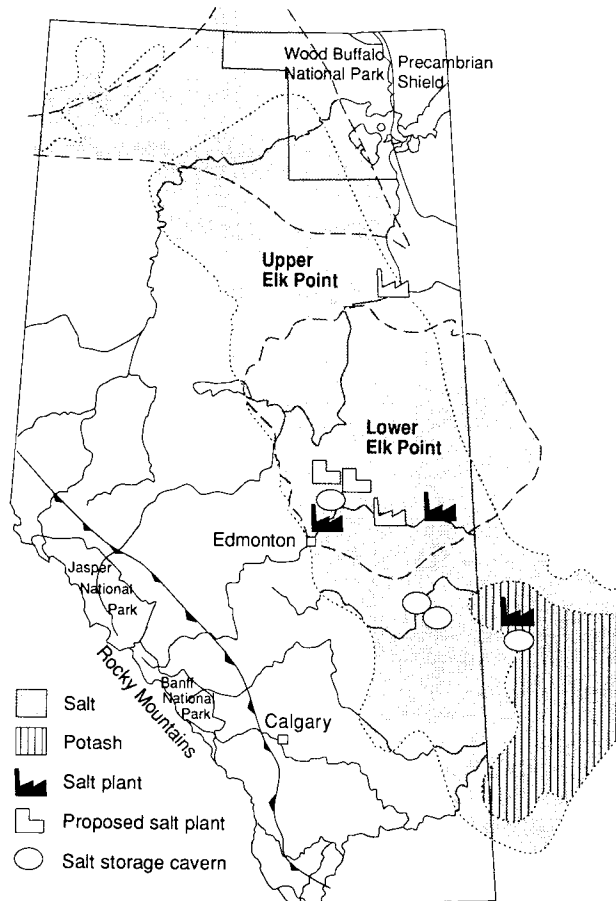

Figure 6. Distribution of Elk Point Group salt deposits and exploitation sites in Alberta.

SAND AND GRAVEL

Sands and gravels are among the most important industrial minerals in Alberta in terms of value. Annual production has ranged from 40 to 45 million tonnes over the last few years, valued at around \$140 million. Deposits are widely dispersed, and production occurs at hundreds of sites. The deposits are found primarily in the surficial sediments, in three main geological types; preglacial, glacial, and Recent alluvial (Edwards, this volume).

SILICA

Several deposits of good quality silica are known in Alberta (Figure 3), but are poorly situated with respect to transportation and markets, and are undeveloped (Hamilton, 1986). The only silica production comes from dune-sand deposits of relatively low grade at Bruderheim, near Edmonton. This type of deposit is very extensive in Alberta, but is of marginal grade, ranging from 90-95% SiO₂. The sand is upgraded for use mainly in the manufacture of fibreglass insulation. Higher grade resources exist in northern Alberta but are undeveloped; these include some highly quartzitic marine sandstones in the Lower Cretaceous Peace River and Pelican Formations, and the McMurray Formation sands that arise as tailings from oil sands processing. Quartzite deposits in the mountains also show promise, but are for the most part untested.

Production of silica in Alberta is not reported, but probably exceeds 150 000 tonnes per annum. The value of production, now lumped with sand and gravel figures, has been in the range of \$4 million to \$5 million annually in recent years.

SODIUM SULPHATE

Deposits of sodium sulphate are common in east-central Alberta, occurring as surface deposits of Recent age formed by evaporation in closed drainage basins under fairly arid conditions (Govett, 1958). Only one deposit has been developed, near Metiskow, about 200 kilometres southeast of Edmonton (Figure 3). This deposit was worked by Aggassiz Resources Ltd. primarily for production of high-purity sodium sulphate for use in detergents. Annual production was about 65 000 tonnes. The operation was shut down in early 1991 due to declining markets.

STONE

The potential for building and dimension stone in Alberta is rather limited because of the soft sedimentary character of the rocks. The only stone currently exploited for building stone in the province is a fine-grain sandstone (grading to siltstone) in the Triassic Spray River Formation, quarried at two sites near Canmore in the Rocky Mountains (Edwards, 1991). Known as Rundle Rock, the stone is dark grey and flaggy, and is used for rough building stone, patio stone, etc. Production is small, less than 100 000 tonnes per annum from the two quarries, operated by Thunderstone Quarries Ltd. and Rundle Rock Building Stone Ltd.

Limited use is made of Paskapoo Sandstone for restoration of historic Alberta buildings originally constructed of this material. This stone is a weak friable

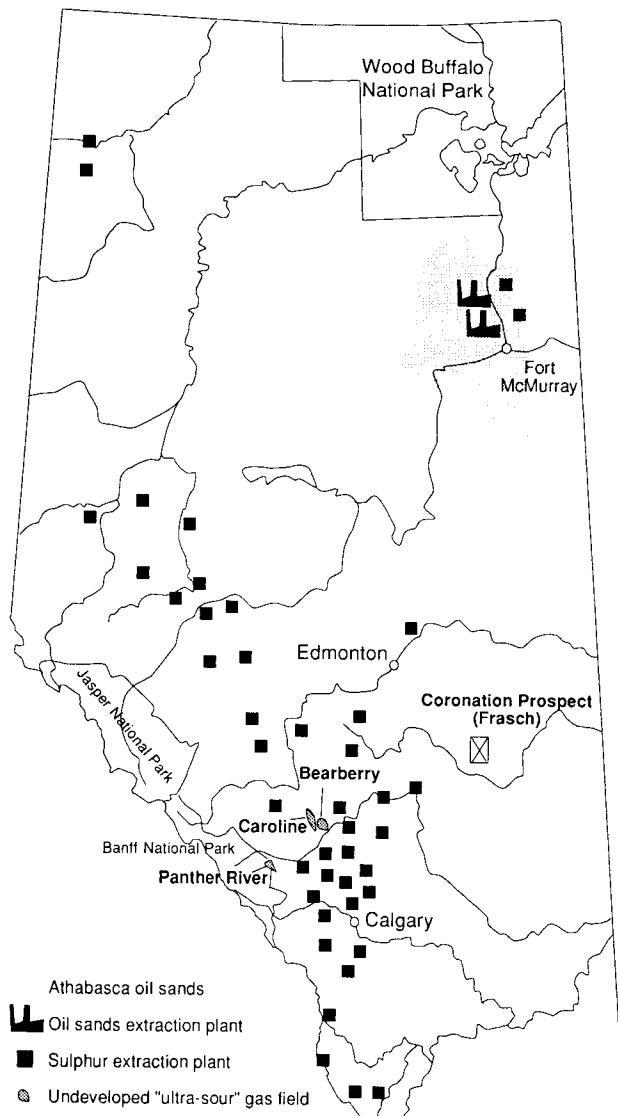

Figure 7. Locations of sulphur extraction plants in Alberta.

sandstone from the Paskapoo and Porcupine Hills Formations of Late Cretaceous and Paleocene ages. As many as 20 quarries of this stone were operated in the past (Godfrey, 1986).

Prospects for potential new development would include sandstones and quartzites in formations of Proterozoic and Cambrian ages in the Alberta mountains, and granites in Archean plutons in the Precambrian Shield region of northeastern Alberta. A quarry test site was opened on a red granite prospect near Fort Chipweyan to examine the feasibility of large block extraction, but initial results were not encouraging. The remote location hampers development potential for this prospect.

SULPHUR

Sulphur is widespread in the Alberta subsurface, occurring primarily as hydrogen sulphide gas mixed with

natural gas or dissolved in formation waters. The sulphur is recovered as a by-product or co-product of sour gas production, from Devonian and Mississippian carbonate reservoirs at more than 50 sulphur extraction plants scattered across the province (Figure 7). A small proportion is recovered from crude bitumen extracted from the Athabasca oil sands near Fort McMurray. Total production in 1990 was 5.3 million tonnes valued at \$315 million.

Sulphur production from sour gas has declined from the peak years of 1980 to 85 due to depletion of conventional resources (i.e. gas fields with H₂S concentrations less than 50% and mostly in the range of 3-20%). However, potential new resources exist in the form of ultra sour gas (70-90% H₂S), and the technology for extraction of these resources is under pilot plant development at the Bearberry field in the southern Alberta Foothills region (Kitzan and Auger, this volume). If the recovery technology proves feasible, reserves from the Bearberry field alone could double the recoverable sulphur reserves in Alberta, which are currently estimated at about 85 million tonnes.

Another prospective future source is native sulphur, found in carbonate-evaporite successions of Devonian, Mississippian and Triassic ages in Alberta and British Columbia (Hora and Hamilton, 1991). Intersections of native sulphur are reported in a number of wells in northeastern B.C., and one occurrence in Alberta has been intensively prospected. Known as the Coronation deposit, this Alberta occurrence is in the basal unit of the Upper Devonian Wabamun Group, where anhydrite has been in contact with petroleum from adjacent porous carbonate beds (Hollister, 1984). The deposit is small (measured reserves 365 000 t), and the depth (1200 m) and average grade and thickness precluded an economic Frasch operation. However, the potential remains for larger deposits in the Wabamun and other carbonate formations elsewhere in Alberta.

POTENTIAL RESOURCES

A number of industrial mineral commodities are not currently produced in Alberta, but are known to be present as potentially economic resources. These are the minerals classed as prospective in Figure 1 and would include such commodities as formation brines (for magnesium, bromide, iodide or lithium production), gypsum, magnetite, and titanium-zirconium minerals. The following is a brief description of the potential for these minerals (excepting formation brines, which is discussed above with reference to calcium chloride production). It also includes the minerals leonardite and phosphate - commodities classed as speculative in Figure 1 but having some definite resource qualities.

GYP SUM

Several gypsum deposits known to exist in Alberta are undeveloped, owing to remote or restricted locations or difficult accessibility (Hamilton, 1982). The deposits occur as near-surface projections of evaporite formations of Devonian and Triassic ages. These evaporites are widespread in the Alberta subsurface as anhydrites, but only in a few locations do they come close enough to the surface to be transformed to gypsum deposits. At least two of the deposits, Peace Point and Fort McMurray, have future development potential. The Peace Point de-

posit has a world class rating in terms of size and purity, but much of it lies within Wood Buffalo National Park and is interdicted from development. The Fort McMurray deposit (~200 km south of Peace Point) is huge, 2 billion tonnes grading 90 per cent plus gypsum, but is a subsurface deposit requiring underground mining. Gypsum exploitation in this region would have to await the industrialization projected with further development of the Athabasca oil sands.

The best potential for gypsum in Alberta could be for undiscovered, shallow buried deposits in the Alberta mountains. Prospective areas for such deposits can be postulated for locations in the disturbed belt where evaporitic strata occur in shallow structural settings. Known evaporite units in the Devonian, Mississippian and Triassic formations would provide prospective targets.

MAGNETITE

Titaniferous magnetite deposits are present at widely scattered localities in the Rocky Mountain Foot-hills belt of southwestern Alberta (Mellon, 1961). The deposits are thin and lensing, forming iron-rich zones at the top of the basal sandstone member of the Upper Cretaceous Belly River Formation. Individual magnetite beds, thought to originate as paleoplacers, are up to 1 metre thick with average Fe₂O₃ content of 29 per cent. Average TiO₂ content is about 3.5 per cent.

The richest deposits are located near Burmis in the Crowsnest Pass, and near Dungarvan Creek, south of Pincher Creek town (Figure 3). Complex faulting and folding at the two sites limit recoverable reserves to about 2 million and 6 million tonnes respectively. Both sites have been prospected as potential sources of magnetite for coal beneficiation.

TITANIUM-ZIRCONIUM MINERALS

Heavy minerals occurring in trace amounts in the Lower Cretaceous McMurray Formation - host formation of the Athabasca oil sands - are rich in titanium minerals and zircon. These heavy minerals become concentrated in the secondary tailings stream during oil sand processing at Fort McMurray, to where they constitute up to 25 per cent of the mineral solids. The concentration is about 100-fold from the original oil sands, such that the tailings become comparable in tonnage and grade to world-scale mineral sands deposits worked commercially for titanium and zirconium minerals recovery (Trevoy, 1984). Titanium minerals (ilmenite, leucoxene and rutile) constitute about 30 per cent of the heavy minerals fraction, zircon about 10 per cent.

No development of this mineral potential has yet occurred, despite the large tonnages of the minerals being wasted annually in the two oil sand plants in the area (114,000 t of titanium minerals and 26,000 t of zircon annually at the Syncrude plant - Trevoy, 1984). As world demand for titanium and zirconium increases, the potential for development of the heavy minerals in Athabasca oil sands is enhanced.

LEONARDITE

Deposits of leonardite - humic acid-rich material formed from oxidation of low rank coal - are found in the Battle River area of central Alberta. Small-scale production has occurred from a deposit associated with Upper

Cretaceous Horseshoe Canyon Formation coals. The deposit consisted of a 1 metre zone of the top of the basal coal seam in the formation. The production was used mainly in drilling mud conditioners; none has been reported since about 1980.

PHOSPHATE

Phosphates and phosphatic rock are common in the Alberta Rocky Mountains. No less than ten formations ranging in age from Devonian to Jurassic are phosphate-bearing in the area (Macdonald, 1987). However, deposits with grades approaching commercial levels are few, limited to the Permian Johnson Canyon and Ranger Canyon Formations and the Jurassic Fernie Formation. Best potential exists for the Fernie Formation deposits in the vicinity of Crowsnest Pass, where grades of 18-26% P₂O₅ have been identified in zones of 1 metre or more in thickness. However, the higher grade resources in this region lie largely within British Columbia. Steep structural settings combined with the submarginal grades for most deposits have deterred any development to date.

REFERENCES

- Edwards, W.A.D. (1991): Geology and Industrial Minerals of the Bow Valley, Banff-Canmore area, Alberta; 27th Forum on the Geology of Industrial Minerals, Banff, Alberta, Fieldtrip 1a Guidebook, 45 pages.
- Edwards, W.A.D. (this volume): The Geology of Sands and Gravels in the Bow Valley Corridor, Alberta.
- Fox, J.C. (1981): Industrial Minerals Tour of the Canmore Corridor, Alberta; Canadian Institute of Mining and Metallurgy Annual General Meeting, Calgary, Fieldtrip Guidebook, 30 pages.
- Godfrey, J.D. (1986): Dimension Stone - Mineral Commodity Profile; *Alberta Research Council*, Open File Report, 1986-13, 21 pages.
- Govett, G.J.S. (1958): Sodium Sulfate Deposits in Alberta; *Alberta Research Council*, Preliminary Report 58-5, 34 pages.
- Guliov, P. (this volume): Overview of Industrial Minerals in Saskatchewan.
- Hamilton, W.N. (1976): Industrial Minerals; Alberta's Uncelebrated Endowment; 11th Forum on the Geology of Industrial Minerals, *Montana Bureau of Mines and Geology*, Proceedings, Special Publication Number 74, pages 17-35.
- Hamilton, W.N. (1982): Salt and Gypsum in Alberta; *Canadian Institute of Mining and Metallurgy*, Bulletin, Volume 75, Number 846, pages 74-89.
- Hamilton, W.N. (1984): Summary of Industrial Minerals in Alberta; in *The Geology of Industrial Minerals in Canada*, *Canadian Institute of Mining and Metallurgy*, Special Volume 29, pages 250-253.
- Hamilton, W.N. (1986): Silica - Mineral Commodity Profile; *Alberta Research Council*, Open File Report, 1986-13, 31 pages.
- Hamilton, W.N. (1987): Field Evaluation of Prospective Filler-grade Limestones in Alberta; *Alberta Research Council*, Open File Report, 1989-14, 51 pages.
- Hamilton, W.N. and Babet, P.H. (1975): Alberta Clays and Shales: Summary of Ceramic Properties; *Alberta Research Council*, Economic Geology, Report 3, 73 pages.

- Hamilton, W.N. and Hora, Z.D. (1987): Industrial Mineral Opportunities in British Columbia and Alberta, Canada; *Society of Mining Engineers*, Annual Meeting, Denver, Colorado, Preprint, Number 87-111, 13 pages.
- Hamilton, W.N. and Mellon, G.B. (1973): Industrial Mineral Resources of the Fort McMurray Area; in Guidebook to Athabasca Oil Sands Area, *Alberta Research Council*, Information Series, Number 65, pages 123-162.
- Hamilton, W.N., Scafe, D.W. and Laidler, J.K. (1988): Evaluation of Kaolin in the Whitemud Formation of Alberta for Use as Paper Filler; *Alberta Research Council*, Open File Report, 1989-5, 79 pages.
- Hitchon, B. (1984): Formation Waters as a Source of Industrial Minerals in Alberta; in *The Geology of Industrial Minerals in Canada*, *Canadian Institute of Mining and Metallurgy*, Special Volume Number 29, pages 247-249.
- Hitchon, B. and Holter, M.E. (1971): Calcium and Magnesium in Alberta Brines; *Alberta Research Council*, Economic Geology Report, Number 1, 39 pages.
- Hitchon, B., Levinson, A.A. and Horn, M.K. (1977): Bromide, Iodide, and Boron in Alberta Formation Waters; *Alberta Research Council*, Economic Geology Report Number 5, 25 pages.
- Hollister, V.F. (1984): Sulphur Potential of the Wabamun Group, Alberta; in *The Geology of Industrial Minerals in Canada*, *Canadian Institute of Mining and Metallurgy*, Special Volume 29, pages 238-243.
- Holter, M.E. (1976): Limestone Resources of Alberta; *Alberta Research Council*, Economic Geology Report Number 4, 91 pages.
- Holter, M.E. and Hamilton, W.N. (1989): An Evaluation of Alberta Limestones for use as Paper Filler Materials; *Alberta Research Council*, Open File Report, 1990-11, 89 pages.
- Hora, Z.D. and Hamilton, W.N. (in press): Native Sulphur Resource Potential in Western Canada; *Society of Mining Engineers*, Annual Meeting, Proceedings, Phoenix, Arizona, 1992.
- Kitzan, P. and Auger, L. (this volume): The Bearberry Ultra-sour Gas Project.
- Macdonald, D.E. (1982): Marl Resources of Alberta; *Alberta Research Council*, Earth Sciences Report, 82-1, 94 pages.
- Macdonald, D.E. (1987): Geology and Resource Potential of Phosphates in Alberta; *Alberta Research Council*, Earth Sciences Report, 87-2, 65 pages.
- Mellon, G.B. (1961): Sedimentary Magnetite Deposits of the Crowsnest Pass Region, Southwestern Alberta; *Alberta Research Council*, Bulletin, Number 9, 93 pages.
- Scafe, D.W. (1975): Alberta Bentonites; *Alberta Research Council*, Economic Geology Report, Number 2, 19 pages.
- Scafe, D.W. (1991): The Ceramic Potential of Alberta Clays and Shales; *Alberta Research Council*, Economic Geology Report, Number 7, 138 pages.
- Tower, R.W., Bertram, E.F. and Melnichuk, J.A. (1991): Evaluation of Alberta Limestone for Precipitated Calcium Carbonate Production Suitability; *Alberta Research Council*, Manufacturing Technologies Department, internal unpublished report, 11 pages, appendix.
- Trevoy, L.W. (1984): Heavy Mineral By-products from Athabasca Tar Sands; in *The Geology of Industrial Minerals in Canada*, *Canadian Institute of Mining and Metallurgy*, Special Volume, Number 29, p. 244-246.
- Turchenek, L.W. and Pigot, M.E. (1988): Peatland Distribution in Alberta; *Alberta Research Council*, map, scale 1:2,000,000.
- Vandervelde, R. (this volume): Ammolite, an Organic Gemstone from Alberta.

OVERVIEW OF INDUSTRIAL MINERALS IN SASKATCHEWAN

By Paul Guliov

Saskatchewan Energy and Mines, Regina, Saskatchewan

ABSTRACT

The diversity and quality of Saskatchewan's industrial mineral resources offer many significant opportunities for development. Recent contributions to the total mineral sales value by industrial minerals in the province range from about 20 to 35 per cent. Industrial minerals production and sales value are dominated by potash, followed distantly by lignite, sodium sulphate, aggregate and salt. While lignite is not normally considered an industrial mineral it is included for practical reasons.

The principal industrial minerals of Saskatchewan are presented under five major groups including salts and brines, clays, construction materials, organics and gem materials. A sixth group, other industrial minerals, represents minor, less well known and poorly documented occurrences. Of the twenty-one principal minerals discussed four are considered to have significant medium term developmental potential. These are subsurface brines, kaolin, dimension stone and silica sand.

While no economic diamond deposits have been reported to date the discovery of at least four macrodiamonds and widespread favorable indicators of kimberlite occurrences are sufficient reasons for optimism and aggressive exploration programs.

Current silica sand development is on a modest scale. Sand quality, resource size and accessibility are factors favoring the development of the sand deposits and diversification of the industry.

A rapid growth in dimension stone markets in North America might favor the development of at least three stone deposits in east-central Saskatchewan. Of particular interest are veined amphibolites similar to verde antique, red and grey dolomite marbles and red and green varieties of granite.

Large kaolin resources in southern Saskatchewan are upgradable at least to paper filler quality. The kaolin with associated ball clays and a variety of Cretaceous and Tertiary stoneware clays could become the basis for growth in the province's clay industry.

Subsurface brines with very high levels of calcium and magnesium chloride have been identified in several areas of the province and are being investigated. In addition, high levels of bromine and significant boron and iodine values improve the economic prospects. If sufficiently large resources are present the brines could be the basis for a very significant chemical industry.

INTRODUCTION

Saskatchewan is host to a diverse group of industrial minerals and rocks that contribute about 20 to 35 per cent of the value of all mineral substances produced in the province (Table 1).

Although the level of contribution by industrial min-

erals is substantial it will likely grow significantly during the next decade based on the diversity of resources and their qualitative and quantitative aspects.

Nearly all industrial minerals production takes place in the Phanerozoic region of the province (Figure 1). Mineral production ranges from potash, sodium sulphate and salt used for their chemical properties to granular aggregate, silica sand and clays used principally for their physical properties. The level of development ranges from very high, as in the case of the world-class potash and sodium sulphate deposits, to low where small-scale single producers serve a limited market (eg. silica flux and bloating clay).

TABLE 1
COMPARISON OF SALES VALUE OF
INDUSTRIAL MINERALS AND OTHER MINERAL
GROUPS

Year	Value of Sales (\$Million)		
	Fuel Minerals	Industrial Minerals	Metallic Minerals
1984	2 073.9	905.1	372.8
1985	2 477.6	698.3	476.5
1986	1 442.8	631.5	467.4
1987	1 788.7	752.3	663.3
1988	1 375.8	1 055.7	493.7

The industrial minerals of the Precambrian Shield of Saskatchewan are less well known than those of the Phanerozoic basin. Numerous occurrences are known but require investigation and better documentation.

INDUSTRIAL MINERAL DEPOSITS

SALTS AND BRINES

POTASH

Of the several Devonian evaporite deposits in Saskatchewan the Middle Devonian Prairie Formation is the only one known to contain potash. The potash mineralization is largely confined to Saskatchewan, (Figure 2), but also extends southward into North Dakota and northeastern Montana and eastward into Manitoba, (Fuzesy 1984). Potash occurs within four members separated by halite in the upper 60 metres of the Prairie Formation (Holter, 1969) (Figure 3). The principal minerals are halite (NaCl), sylvite (KCl) and carnallite (KCl.MgCl₂.6H₂O). Insoluble content consists largely of anhydrite with minor clay, dolomite, quartz and iron oxide. Sylvite grades of about 30 per cent are common in all members.

The Prairie Formation has a regional gradient ranging from 1:450 to 1:160 due south in western areas and southwest in eastern areas. The evaporite beds are inter-

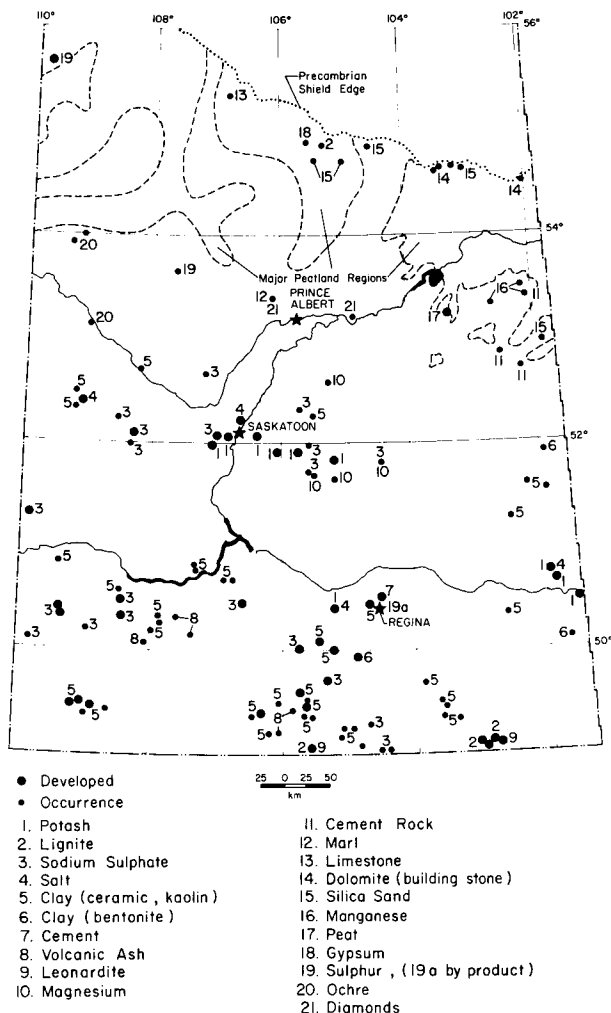

Figure 1. Industrial minerals distribution in southern Saskatchewan.

rupted by numerous solution channels and hollows, some of which were formed shortly after deposition and others at considerably later times as is indicated by accompanying collapse features in beds overlying many of these occurrences. There is evidence that some may be a result of diatreme intrusion.

Potash resources are generally accepted as being extremely large. Barry (1979) calculated reserves for single and double level conventional mining as 10.5 and 14.0 billion tonnes K₂O equivalent respectively. However, the influence of solution structures on recoverable reserves particularly in the region where the ore is at a conventional mining depth of 1100 metres or less make accurate estimates impractical. Deeper resources recoverable by solution mining are estimated to be at least 42 billion tonnes K₂O equivalent.

The industry in Saskatchewan comprises six producing companies operating two solution mines and 8 conventional mines. One of 9 underground mines was closed in 1987 due to flooding but was subsequently converted to a solution mining operation. Saskatchewan producers supply about 25 per cent of world potash demand, second only to the Soviet Union. Production peaked in 1980 and 1984 at about 7.5 million tonnes K₂O. The industry ap-

pears to be recovering following a post-1984 slump in production and prices. Production in 1988 exceeded 7 million tonnes K₂O. The present productive capacity of Saskatchewan mines is estimated at about 9.3 million tonnes K₂O equivalent.

Recent research and a demonstration of high quality commercial potassium sulphate production from sylvite and sodium sulphate met with considerable success at a pilot plant operated by the Potash Corporation of Saskatchewan at Big Quill Lake. The pilot plant uses an ion exchange process and has a capacity of 10 tonnes per day. The production rate presently is about 6.5 tonnes per day. Potassium sulphate is used as a fertilizer for chloride-sensitive crops. Additional markets could be realized with a substitution of potassium chloride for sodium chloride in the regeneration of water softeners.

The potash industry is dependent on the fortunes of the world agricultural economy as over 95 per cent of production is consumed in fertilizers. It is unlikely that alternate uses would have a significant effect on demand in the foreseeable future, however the industry is making efforts to expand markets and improve its competitive position in the world markets by improving efficiency of mining, processing, product handling and mine stability. Since 1985 various federal and provincial programs have provided the potash industry with assistance in market development and technical and environmental research.

SODIUM SULPHATE

Numerous closed basins or depressions in southern Saskatchewan resulted from various glacial and proglacial processes. Many of the basins, usually of the channel or riverine type but also the sinkhole and broad depressional types, contain deposits of sodium sulphate (Last and Slezak, 1987). The most abundant mineral salts are mirabilite (Na₂SO₄·10H₂O), thenardite (Na₂SO₄), bloedite (Na₂Mg(SO₄)₁₃·15H₂O) as well as magnesian sulphates such as epsomite and kieserite. Some deposits display an upward increase in magnesian salt with a corresponding decrease in sodium sulphate.

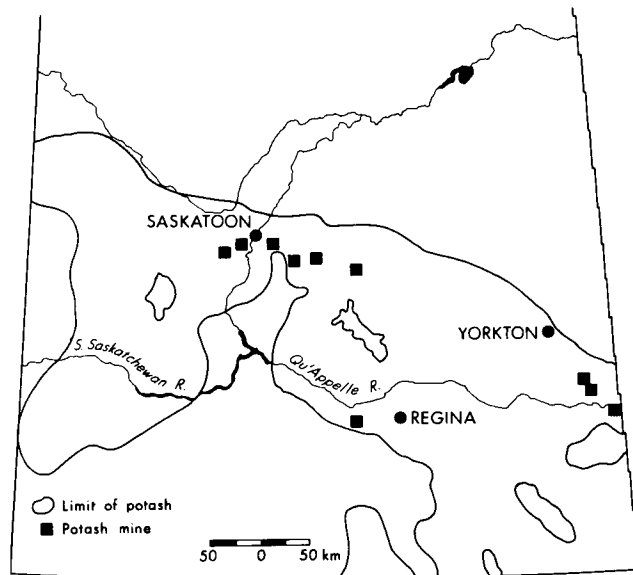

Figure 2. Potash regions of Saskatchewan.

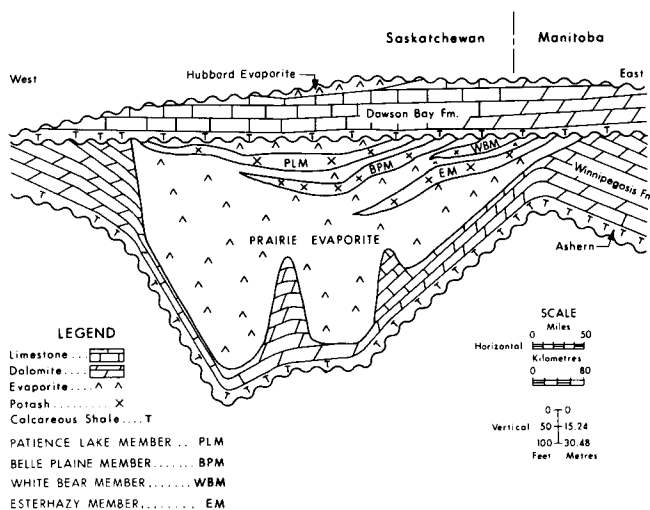

Figure 3. Diagrammatic cross section through the Prairie Formation in Saskatchewan and Manitoba (after Fuzesy, 1982).

The origin of the ions in these lakes is not yet fully understood. It appears likely however, that they may be derived from several sources or combinations thereof including:

- (a) shallow ground water
- (b) deep ground water possibly modified during ascent
- (c) surface leaching of the surrounding terrain

Evaporative concentration of the lake waters takes place during warm dry summers. Declining autumn temperatures precipitate salt crystal beds of the Na-Mg-SO₄ type (Tomkins, 1954, Last and Schweyen, 1983). Partial dissolution of the crystal beds during the following summer results in a net accumulation of permanent salt crystals. Repetition of such cycles gradually adds to the permanent crystal beds. Some of the deposits are of exceptionally high grade containing in excess of 90 per cent sodium and magnesium salts. Typical crystal bed thickness is 1 to 5 metres but in a few locations exceeds 30 metres. Natural sodium sulphate deposits are generally interlayered with impurities of silt, clay and biogenic material.

Tomkins (1954) identified 21 Saskatchewan deposits as containing between 500 000 tons and 9 million tons of anhydrous sodium sulphate. Twenty-four others were listed as containing between 100 000 tons to 500 000 tons. The distribution of these and others is shown in Figure 4.

Saskatchewan's sodium sulphate industry comprises four producers operating six plants. The total capacity of the industry is over 600 000 tonnes of anhydrous product. Two grades are produced; saltcake with a minimum of 97 per cent Na₂SO₄ used largely in the kraft paper industry and detergent-grade with up to 99.77 per cent Na₂SO₄ used mainly in the detergent, glass and chemical industries.

Total annual production peaked at nearly 510 000 tonnes in 1982 and gradually declined to about 272 000 tonnes in 1988. The average price during the same period remained fairly stable at \$85.00 to \$98.00 per tonne until 1986 followed by a decline to about \$81.00 in 1988.

SALT

Significant halite (NaCl) resources in Saskatchewan are of two main types: (a) massive strata of halite and (b) subsurface formation brines. A third type, of lesser economic significance, occurs as saline springs.

Resources of halite occurring in massive beds of Devonian age (Figure 5) are practically unlimited. The Middle Devonian Prairie Formation extends over most of the southern third of the Province and comprises the largest salt deposit. The formation varies in depth from the surface between 400 to 2 700 metres and averages about 120 metres in thickness. Other Devonian halite deposits of economic significance are the Dawson Bay Hubbard Evaporite and the Duperow Flat Lake halite (Dunn, 1975, Lane 1959, 1964). Deposits of lesser significance occur in the Mississippian Poplar and Ratcliffe beds of southeastern Saskatchewan. Thick, halite deposits are of economic significance not only for their salt resources but also as a medium for the development of salt caverns for the storage of natural and manufactured gases.

Subsurface brines in Phanerozoic formations increase in concentration with depth toward the Williston Basin centre. Maximum chloride concentrations in excess of 189 000 milligrams per litre are recorded in the deeper aquifers and about 38 000 milligrams per litre in the younger and shallower Mesozoic aquifers (Simpson and Dennison, 1975). Calcium and magnesium are common constituents in Devonian and older aquifers. Concentrations of calcium can reach a level of over 119 000 milligrams per litre and magnesium of over 51 000 milligrams per litre. Anomalous values of K, Br, I and B have also been reported.

Saline springs are common near the northern subcrop of Devonian rocks particularly in the region of Porcupine Mountain and Pasquia Hills (Simpson and Dennison, 1975). There are also scattered occurrences in western Saskatchewan and along the northern limit of the Athabasca Basin.

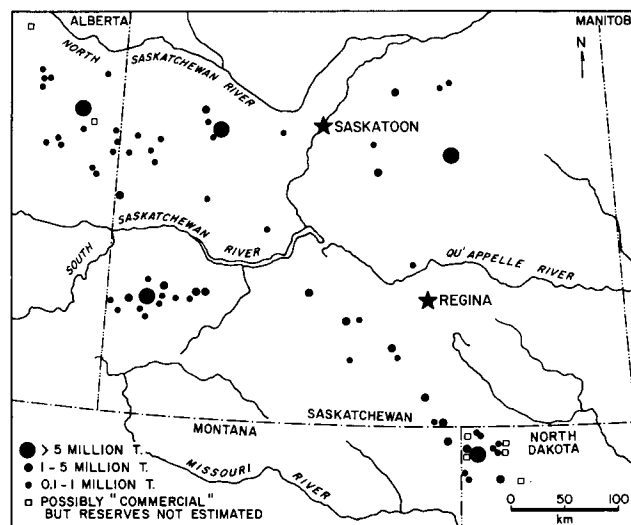

Figure 4. Distribution and size of sodium sulphate deposits of the northern Great Plains (after Last and Schweyen, 1983).

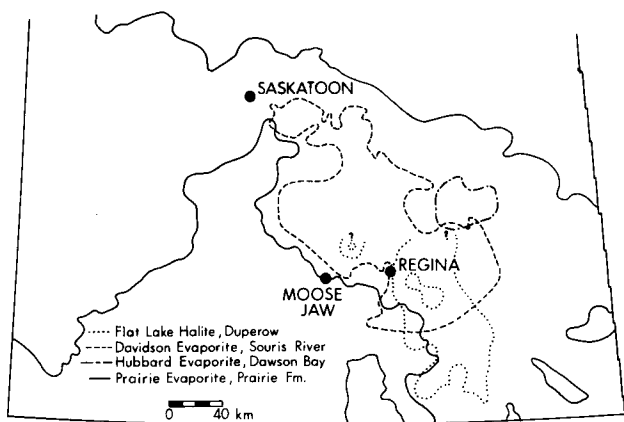

Figure 5. Distribution of salt in Devonian Formations of Saskatchewan.

The salt industry in Saskatchewan comprises four producers:

- Sifto Canada Inc. at Unity, producing fine vacuum-pan salt and fused salt,
- Canadian Salt Company Limited near Belle Plaine, producing fine vacuum-pan salt, livestock salt and ice-control salt,
- Saskatoon Chemicals Division of Weyerhaeuser, Saskatoon, producing caustic soda, chlorine and sodium hypochlorite for the pulp industry, and
- International Minerals and Chemical (Canada) Corporation Limited, near Esterhazy, producing ice-control salt as a by-product of potash mining.

Total production during 1988 was over 416 000 tonnes with a value of about \$20 million.

SUBSURFACE BRINES

Brine rich in calcium chloride has been seeping into the PCS Mining, Cory Division potash mine near Saskatoon since 1971. Inflow is reported from five widely scattered locations at rates ranging from less than one litre per minute to eight litres per minute. Buchinski, (1988) reported the following typical brine composition:

Ca ⁺⁺	138 000 ppm
Mg ⁺⁺	23 400 ppm
K ⁺	21 100 ppm
Na ⁺	6 300 ppm
Sr ⁺⁺	1 600 ppm
Cl ⁻	321 000 ppm
Br ⁻	4 890 ppm
SO ₄ ⁻	13 ppm
pH	4.6
S.G.	1.36
calcium chloride	28.1%
magnesium chloride	6.7%
potassium chloride	3.0%
sodium chloride	1.2%

The company has marketed the brine since 1987 principally for treatment of gravel roads. Total demand for road treatment brine in Saskatchewan is reported by Buchinski as 10 000 000 litres per year. The brine may also be used as a refrigerant and as tire ballast.

Magnesium-rich residual brines at the Cory mine

are believed to have migrated from the Prairie Formation into the overlying Dawson Bay Formation. Calcium-magnesium ion exchange occurred in the Dawson Bay carbonate during dolomitization and the residual calcium-enriched brine was entrapped therein, particularly in areas where the Prairie Formation is topographically low (Buchinski, 1988). An effective trapping mechanism may have been provided by salt plugging in the upper part of the Dawson Bay Formation where salt would have been released at the intermixing zone between halitic and calcitic brines.

Magnesium and calcium-rich brine occurrences in Middle Devonian carbonate formations are widely scattered throughout the Elk Point Basin in Saskatchewan (Figure 6). Concentrations of Ca⁺⁺ and Mg⁺⁺ ions up to 135 000 and nearly 90 000 milligrams per litre respectively are known and locally bromine levels are as high as 5 400 milligrams per litre. There is also some potential for iodine, boron and lithium.

Although resource evaluation has yet to be completed on these brines there is good reason to infer, from stratigraphic studies, that the resource is probably very large. Should the inference be borne by the results of further geological, engineering and chemical investigations the resource could be the basis of a major and diverse chemical industry.

MAGNESIUM SALTS

The Middle Devonian Prairie Formation in the Watrous-Nokomis region about 100 kilometres south-east of Saskatoon, contains high concentrations of carnallite (KCl · MgCl₂ · 6H₂O). Grades in the Belle Plaine Member and the lower part of the Patience Lake Member average from 50 to 68 per cent carnallite over large areas and locally are in excess of 90 per cent. The carnallite-rich Belle Plaine Member in the Quill Lakes area has an average thickness of about 14 metres.

Some of Saskatchewan's saline lakes contain significant concentrations of magnesium sulphate. In particular Big Quill Lake and Redberry Lake contain over 2 per cent Mg₂SO₄ in conjunction with sodium sulphate and

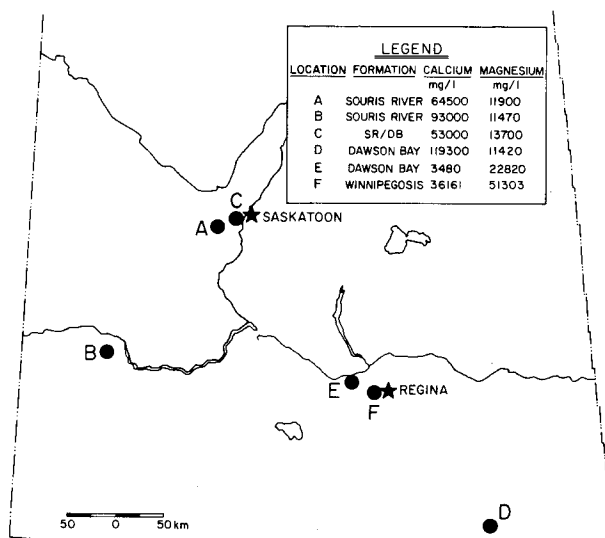

Figure 6. Occurrences of high-salinity brine in Devonian Formations, Saskatchewan.

sodium chloride. Magnesium resources in these and several other lakes were presented by Tomkins, (1953) as follows:

Big Quill	2.2 million tons
Redberry	1.85 million tons
Basin	0.85 million tons
Little Manitou	0.325 million tons
Aroma	0.12 million tons
Muskiki	0.11 million tons

Magnesium in subsurface formation brines are dealt with in a separate section.

CLAYS

SWELLING BENTONITE

The Late Cretaceous Bearpaw Formation represents the last extensive marine episode in Saskatchewan. Bearpaw sediments now extend over much of southwestern Saskatchewan and are exposed in many localities. The formation is a sequence of clays, silty and sandy clays and subordinate sands. Westward and northwestward the sequence wedges out into mainly terrigenous and continental sands. Eastward it thickens, becomes more argillaceous and merges with the Riding Mountain Formation. Bearpaw sediments are best exposed along the Frenchman River and along the South Saskatchewan River from Riverhurst eastward. Other exposures may be found along Notukeu Creek and its tributaries, along the Qu'Appelle River Valley from Buffalo Pound Lake northwestward and in the badlands between Avonlea and Moose Jaw Creeks.

The Bearpaw sequence of the South Saskatchewan River valley is 350 metres thick. Caldwell (1968) subdivided it into eleven members. One of these, the Snakebite member occurs just above the midpoint of the sequence and consists largely of medium to dark grey clay with numerous bentonite seams and subordinate bedded clay-ironstone and limestone concretions, nodules of fibrous calcite and septaria (Caldwell, 1968).

The Snakebite Member was deposited during the maximum extent and depth of the Bearpaw sea (Caldwell, 1982). At that time the western Cordilleran belt was experiencing increasing orogenic activity and frequent events of explosive volcanism. These events are now recorded as numerous bentonite beds in the Bearpaw sequence, particularly in the Snakebite Member. These beds are thin in the type locality of the Snakebite but exhibit their greatest known development in the Truax area where the member is exposed between Avonlea and Moose Jaw Creeks. Salt solution collapse and development of a local basinal environment in the area during Snakebite time were likely instrumental in the accumulation of thicker bentonite beds in the sequence.

Bearpaw sediments are exposed in the Truax area about 50 kilometres southwest of Regina. The formation is structurally disturbed by a complex network of faults along which vertical displacement is 2 metres or more. The area directly overlies the northern extension of the Hummingbird Trough, a negative feature arising from dissolution of Middle Devonian evaporites and subsequent collapse. The development of the Blackfoot Ridge badland topography in the area is, at least in part, due to salt solution subsidence or collapse. In addition to normal faulting the bentonite beds have been complicated to

some extent by erosion and glacial thrust faulting and folding. Glacial overburden in the area ranges up to about 6 metres thick.

Three bentonite beds have been identified in the Truax area ranging in thickness from 30 centimetres to 61 centimetres. Monea (1984) indicated a bed separation of 365 centimetres for the upper two and 182 centimetres for the lower two beds. Depending on vertical fault displacement and the state of erosion either of the upper two beds may lie at surface, at the bedrock-drift contact or within the Bearpaw shale sequence. The basal contacts of the bentonite beds are sharp and usually marked by a thin layer of fibrous or columnar calcite whereas the upper contacts are gradational (Hudson, 1984). Isolated pods of unweathered volcanic ash are rarely present at the base of the beds.

Avonlea Mineral Industries Ltd. was the sole producer of swelling bentonite in Saskatchewan from 1978 to 1990 when it went into receivership. The company operated a quarry near Truax and an 80 000 tons per year capacity plant at Wilcox about 24 kilometres north of the quarry. The operation was taken over by Canadian Clay Products Inc. in early 1991. Three grades of bentonite were produced:

- normal - used as a sealant in civil engineering and as an animal feed binder
- mud - with a higher yield and viscosity and used for drilling mud and pelletizing iron ore
- blue - from the lowest of three beds, has a lower viscosity than mud grade, a higher pH, a sky blue color and high hot strength. It was marketed as a foundry sand binder.

The grade generally dictates the ultimate use of the material. Some of the more common applications were:

- drilling mud industry
- iron ore pelletizing
- reservoir sealant and other civil engineering applications
- animal feed binding and
- foundry sand binding

Potential markets lie in an expansion of civil engineering applications in western Canada, the use of bentonite as a carrier for pesticides and in the treatment of industrial and urban waste water.

Swelling bentonites of Tertiary age occur along the westward extension of the Big Muddy valley system from the area between Willow Bunch and St. Victor westward to Twelve Mile Lake. The bentonite is exposed in numerous spurs along the valley walls. The best known deposits are those in the St. Victor-Pickthall area in townships 5 and 6, ranges 29 and 30W2.

Based on over 200 exploratory boreholes in the St. Victor area the bentonite normally occurs in one seam but in a few isolated localities a second seam is present. The seam thickness varies from 0.3 metres to 5.2 metres. Overburden to seam thickness ratios range from very low in the valley bottom to 20 or more at higher elevations along the flanks.

The quality of the bentonite and its application in iron ore pelletizing have been investigated by industry. Shallow samples were found to have higher viscosity and colloid content than deeper samples. Of 69 samples about half had a colloid content of over 60 per cent. The

average viscosity (Marsh Funnel) of 79 samples was 18.5 seconds.

The St. Victor bentonite was found to be quite variable from locality to locality in its properties and its suitability for pelletizing iron ore. Some functioned well unbeneficiated while others required blending and upgrading with NaOH. A small amount of testing was conducted for its application as a drilling mud and foundry sand bond. The results are promising but variable and the clay generally required significant processing and chemical upgrading.

NON-SWELLING BENTONITE

Calcium or non-swelling bentonites occur in several areas of the province in formations of late Cretaceous and Tertiary ages (Winer, 1954):

- Vermillion River Formation along the Swan River north of Pelly
- Riding Mountain Formation south of Moosomin
- With Eocene-Oligocene pumicite west of Rockglen, and
- Battle Formation along the Frenchman River southwest of Eastend.

Little is known of the extent or reserves of bentonite in these areas but, with the exception of the Moosomin area, the deposits were reported to have potential for considerable tonnage. These clays are promising as oil decolorizing agents, cracking catalysts and absorbents. Winer (1954) found that bentonites from the Pelly and Moosomin areas are superior to commercial clays in their decolorizing properties. The Pelly bentonite also has a high catalytic activity.

KAOLINITIC AND OTHER CLAYS

Industrial clays other than bentonite are derived from the Upper Cretaceous Whitemud Formation, the Willow Bunch member of the Tertiary Ravenscrag Formation and from Quaternary lacustrine sediments.

The Whitemud Formation is a sequence of fluviolacustrine sediments consisting of kaolinitic sands and silts with minor lignitic clay and sand zones usually capped by plastic kaolinitic ceramic clays and silty clays. The formation lies conformably on continental quartzofeldspathic sands and silts of the Eastend Formation. In some areas the Whitemud is overlain conformably by the bentonitic clays of the Battle Formation or disconformably by sediments of the uppermost Cretaceous Frenchman Formation, the Tertiary Ravenscrag Formation, Pleistocene till or recent sediments.

Over the past 75 years or more the Whitemud Formation has yielded plastic stoneware clays of various characteristics, refractory clays of low to high duty, light to white-burning ball clays, and kaolinized sand as components for various ceramic wares (particularly structural products). Whitemud clay resources are found in the Eastend-Ravenscrag Butte area, Wood Mountain-Flintoft area, the Willow Bunch-Verwood-Readlyn area and the Dirt and Cactus Hills near Claybank. The clays exhibit an eastward increase in refractoriness and plasticity. The Whitemud Formation currently yields raw material to Estevan Brick Ltd. for structural and face brick produced in Estevan; I-XL Industries Ltd. for sewer pipe, flue linings and brick produced near Regina; and Plainsman Clay Ltd. for pottery clay bodies at Medicine Hat,

Alberta. Refractory bricks have been produced from Whitemud clays near Claybank since about 1914. The most recent operator, A.P. Green Refractories (Canada) Limited, closed the operation in 1989.

Kaolinized sands of the Whitemud Formation occur as structureless or bedded deposits up to 18 metres thick with a kaolin content ranging from 50 to 60 per cent. Recent work by Ekaton Industries Inc., the Saskatchewan Research Council and the Colorado School of Mines was successful in upgrading the Whitemud kaolin to a General Electric reflectance level of 82 per cent. This represents a major step toward developing the deposits for use in the filler and extender industry, particularly in paper manufacturing. Master (1987) had calculated the geological reserves of kaolinized sediments in the Wood Mountain area as over 340 million tonnes, over two thirds of which have a stip ratio of 1:1 or better. The calculations were based on an average thickness of 6.1 metres, an exclusion of all areas of less than 4.6 metres thickness of kaolinized sand and a bulk density of 1.75.

Plastic clays, frequently found overlying the kaolinized sands, are generally of the stoneware type in the Eastend area whereas in the Wood Mountain-Willow Bunch area they are, more commonly, of the ball clay and fire clay type. The clays are up to several meters thick and, in some localities, lie on the kaolinized sands with an unconformable relationship, apparently as channel fill (Hudson, 1984). Hudson (1984) indicated a pyrometric cone equivalent commonly in the range of 29 to 31 and occasionally up to 32 to 32.5 for clays in the Wood Mountain area and localities farther east.

Industrial clays of the Paleocene Ravenscrag Formation appear to be confined to an alternating sequence of clay, lignitic clay and silt beds in the Willow Bunch Member. Individual bed thicknesses of 1.5 to 3.7 metres have been recorded in the upper part of the formation. These clays are found outcropping in the dissected uplands high in the Ravenscrag Formation south of the Big Muddy valley, near Willow Bunch Lake and in the Wood Mountain plateau.

Clays of the Willow Bunch member are kaolinitic and generally less refractory than those of the Whitemud Formation. X-Ray diffraction analyses show broad kaolin peaks indicating poor crystallinity. Willow Bunch Member clays generally contain higher proportions of feldspars and alkalis than Whitemud clays. Locally kaolinization and leaching of alkali content is more pronounced and the clays achieve a low grade refractory quality. Worcester (1950) indicates a wide range of pyrometric properties among Ravenscrag clays. Bluestoning occurs over a range of cone 04 to 8 but clay bodies may survive from cone 3 to 6. These clays generally burn to colors ranging from light to dark salmon red, yellow and, occasionally, grey. Their maturing range tends to be fairly narrow.

Willow Bunch Member clays have not been well explored on a regional basis. Significant deposits are known to occur in the Harptree and Willow Bunch areas and in the Rockglen and Strathallan areas south of Wood Mountain. The latter two areas are of particular interest due to the thin drift cover. Clays of the Willow Bunch Member are exploited for the production of face brick by Estevan Brick Ltd. in Estevan and have been successfully tested for tile manufacturing in Thunder Bay. A small amount is used by local potters.

Recent glaciofluvial and glaciolacustrine clays are widespread in southern Saskatchewan. Many small brick-yards utilized these clays in the early days of settlement (Ries and Keele 1912, 1913; Keele 1915; Davis 1918; Worcester 1950). They are no longer used for this purpose. However, the bloating characteristics of many of these clays make them useful raw materials for the pro-

duction of lightweight or expanded aggregate. Plants at Saskatoon and Regina operated by Cincrcrete Products Ltd. produce such an aggregate for use in light concrete products.

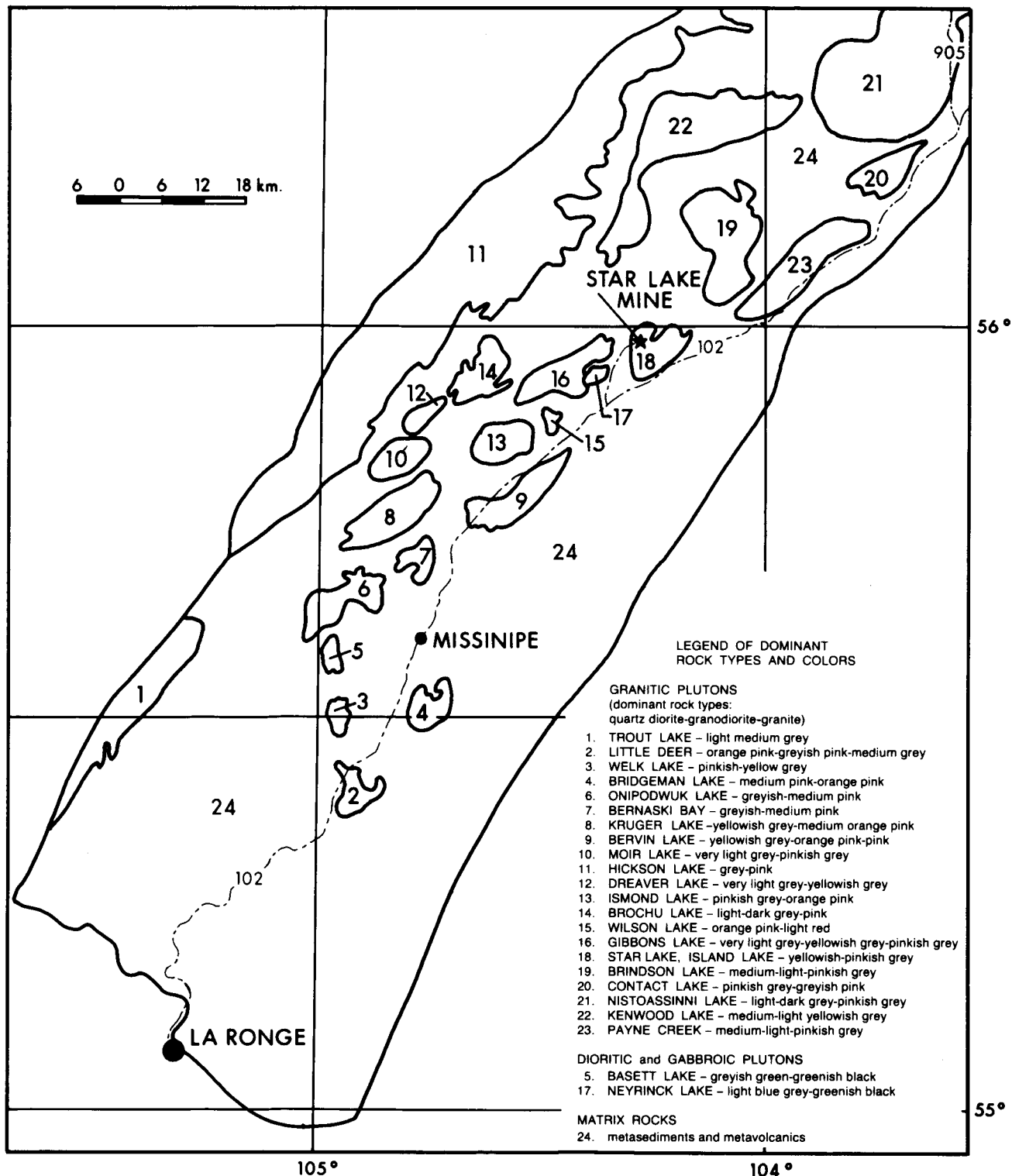

Figure 7. Major plutons of the La Ronge domain.

CONSTRUCTION MATERIALS

BUILDING STONE

Except for limited use of local glacial erratics (field-stone) for structural and decorative masonry Saskatchewan produced no building stone until very recently despite the large resource potential. A wide variety of igneous and metamorphic rocks are accessible from several major routes in the Precambrian region north and east of La Ronge, some of which are likely to be suitable as dimension stone. Dolomites occur over a large region in east-central Saskatchewan extending southward from the Hanson Lake Road (Highway 106) to the Cumberland Lake area.

Preliminary investigations between 1986 and 1988 in the La Ronge Domain indicate the region has the potential to yield granitic materials suitable for dimension stone. Investigations were conducted on ten plutonic bodies in the La Ronge Domain within relatively short distances of Highway 102 (Figure 7). Six of the ten plutons examined in the La Ronge Domain (particularly the Neyrinck Lake pluton) are considered to be candidates for more detailed investigation. These are Bridgeman Lake, Neyrinck Lake, Kruger Lake, Island Lake, Dicus Lake and Bassett Lake.

Thomas (1984) described the Neyrinck Lake pluton as mesogabbro to leucogabbro with minor amounts of melagabbro. The rock is now considered to be a diorite. Field examinations indicate the diorite contains 15 to 50 per cent hornblende, 50 to 85 per cent plagioclase and traces of biotite and rare grains of pyrite. Grain size varies from 3 to 10 millimetres. Hornblende clots rarely larger than 25 x 35 centimetres and hornblende dykes less than 10 centimetres wide are common and tend to be parallel to the fracture direction. Mineral alignment is

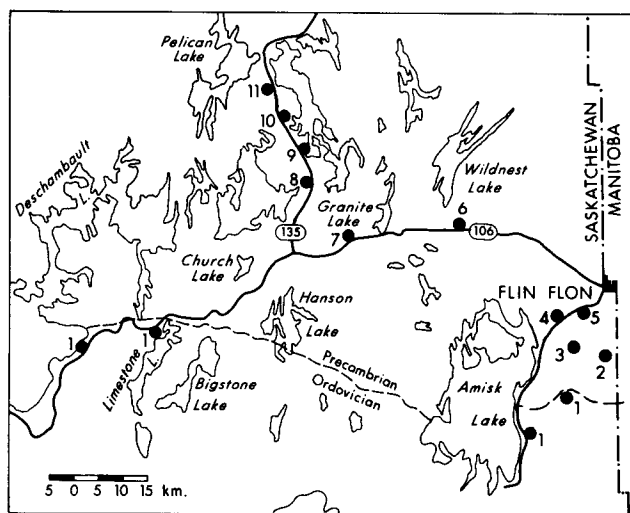

LEGEND	
1 Dolomite, Dolomite marble	7 Augen Gneiss
2 Red Granite	8 Black Gneiss
3 Amphibolite (verde antique)	9 Banded Gneiss
4 Red Granite	10 Red Gneissic Granite
5 Banded Tuff	11 Green Granite
6 Grey Granite	

Figure 8. Potential building stone sites in east-central Saskatchewan.

generally rare except for some primary flow banding and the rock as a whole appears structureless.

Fractures, commonly intersecting at 90° to 120°, are vertical to steeply dipping and are usually spaced greater than 1 metre apart. The uppermost horizontal fracture is commonly less than 0.5 metres below the surface and the next is greater than 1 metre below the first. Natural orthogonal blocks, separated from the outcrops, are commonly greater than 1 metre per side and rarely larger than 2.5 metres per side. Microfracturing appears to be most common in a felsic phase of the diorite. Preliminary indicative compressive strength values range from 182.2 to 246.5 MPa (26 420 - 35 750 psi) dry and 172.4 to 194.3 MPa (25 000 - 28 180 psi) wet. The results of field investigations and laboratory tests are encouraging and additional investigations are warranted.

Dolomites of the Ordovician Red River Formation along Highway 106 in the Limestone Lake area were investigated for their dimension stone potential. Core drilling and engineering tests were conducted under the Mineral Development Agreement in 1985 (Mysyk and Edwards, 1985). The results indicate a type III high-density dolomite of superior compressive strength and modulus of rupture far in excess of minimum A.S.T.M. requirements (191.7 and 138 MPa respectively). Insignificant loss in a sodium sulphate test indicates good durability in freeze-thaw conditions. X-Ray diffraction analyses indicate 98 to 99.5 per cent dolomite with minor quartz and traces of clay, calcite and anhydrite. Colors range from buff to mottled buff and grey shades, purple mottled, purple-buff mottled and occasionally red.

The dolomite has good potential for use as rubble building stone and random ashlar. Veneer slab could be produced if larger blocks are available farther west of Limestone Lake where the rock is less influenced by the Tabernor fault system or in the Amisk Lake area. The estimated resource of readily available dolomite in the Limestone Lake area is about 120 million cubic metres. Limited quarrying of the dolomite commenced in 1989 for the construction of the agricultural building at the University of Saskatchewan in Saskatoon.

Investigations by Pearse during 1989 and 1990 in the areas of Amisk Lake, Creighton to Jan Lake and Jan Lake to Pelican Narrows have outlined additional promising stone resources (Figure 8). Of particular interest are:

- several varieties of Ordovician dolomites near Amisk Lake which take an excellent polish and are therefore classified as marbles. Varieties include red, buff-grey mottled and yellow-red mottled. Potential block sizes appear to be sufficiently large to warrant test quarrying.
- veined dark green amphibolite in the Mystic Lake area resembling verde antique. Quarrying of full size blocks appears to be possible but additional work is required to assess the waste factor.
- highly banded gneisses in the Maligne Lake area and along the Pelican Narrows Road.
- orange and black granitic gneiss ("Tiger Granite") marginal to the Sahli granite in the Pelican Narrows area.
- charnockite (Sahli granite), an extensive body of green granite immediately south of Pelican Narrows.

TABLE 2
COMPARATIVE ANALYSES OF SHALES FROM THE FAVEL AND VERMILLION RIVERS

	PER CENT				
	SiO ₂	Fe ₂ O ₃	Al ₂ O ₃	CaO	MgO
Waskwei River shales	17.32	2.48	5.67	35.37	0.76
Lehigh Valley cement rock	19.82	ND	5.40	38.9	2.72
Sturgeon Lake Marl	26.09	2.31	3.48	30.78	2.11

(The remaining constituent in each case is taken to represent LOI).

LIMESTONE, DOLOMITE, CEMENT ROCK

Limestone is not known to outcrop in Saskatchewan. Although subsurface limestones of Devonian, Mississippian and Jurassic ages are widespread it is only near the northern Phanerozoic limit that Devonian limestone is near the surface.

Devonian limestone boulders containing 97 per cent CaCO₃ were reported at surface near the shore of Lac La Ronge about 1.6 kilometres southeast of the mouth of the Bow River. Drilling by industry in the Bow River area has revealed about 5 metres of similar limestone at depths ranging from about 30 metres to 45 metres. Inferred resources were estimated at 10 million tonnes containing 52.5 per cent CaO, 3.0 per cent MgO and 0.7 per cent insolubles.

Exploratory drilling in the area near the south end of Pinehouse Lake (W7-34-73-6 W3) encountered about 11 metres of high-calcium limestone in the Middle Devonian Meadow Lake Formation at a depth ranging from 68 metres to 79 metres. The average CaO content is 54.2 per cent. Average SiO₂, Al₂O₃, MgO and Fe₂O₃ contents are very low (Fuzesy, 1980).

Dolomites of Ordovician and Silurian ages occur at and near surface in the region extending northward from Cumberland Lake to Deschambault and Amisk Lakes in east central Saskatchewan. Generally the dolomites are hard, dense, fine- to medium-grained, range in color from shades of yellow and buff to orange, brown, purple and mottled combinations of these and infrequently contain thin dolomitic shale bands. Horizontal joints are normally quite pronounced in outcrops and ranges from flat to undulose. Thicknesses of the deposits range from thin at the subcrop edge to nearly 200 metres in the Cumberland Lake area. The dolomite sequence consists of the Ordovician Red River and Stony Mountain Formations and the Silurian Interlake Group. With a few exceptions chemical analyses of Red River dolomite indicate an MgO content from 19.5 to 20.6 per cent. Al₂O₃, Fe₂O₃ and SiO₂ are present in minor amounts. Kupsch (1952) conducted an extensive field study of the entire region and the report remains as the principal regional reference.

Potential uses for the Red River dolomite include dolomite lime, crushed aggregate, flue gas desulfurization, fluidized bed combustion and poultry grit, (Mysyk and Edwards, 1985). The dolomite is also a potential raw material for the production of calcium magnesium acetate for use as a road de-icing material, particularly for concrete highway structures prone to damage by ordinary salt.

Calcareous shales (cement rock) of Late Cretaceous

age occur in the Hudson Bay-Pasquia Hills region. The host rocks are of the Boyne Member of the Vermillion River Formation and the Favel Formation (equivalent of the Late Cretaceous First and Second White Speckled shales respectively). They outcrop along the flanks of the Pasquia Hills and occur at shallow depth immediately southeast of Hudson Bay. The Boyne and Favel in the latter area attain a maximum thickness of about 9 metres and 18 metres respectively and are separated by up to 21 metres of petroliferous shale of the Morden Member (Vermillion River Formation). Thicknesses appear to be variable in the region. Drilling by industry in the Hudson Bay area has outlined large tonnages of cement rock grading in excess of 37.5 per cent CaO at a stripping ratio of 1:1 or less (Walker, 1987). Alkali values appear to have an inverse linear relationship to CaO values. Shales with 37.5 per cent or more CaO contain about 1.4 per cent or less combined Na₂O and K₂O. Organic matter in the shales result in an average thermal value of about 500 000 KCal/tonne.

Beck (1974) described and sampled good exposures of the shales along the Waskwei and Bainbridge rivers. He compared the weighted average composition of the shales with analyses of typical cement rock from the Lehigh Valley and with a marl deposit in Sturgeon Lake, Saskatchewan (Table 2).

Utilization of the Favel and Vermillion River calcareous shales for cement manufacturing is a possibility if grade variations meet industry requirements. Additional sampling and analytical work are required to delineate the best resource areas, stratigraphy and grade variation. These formations also occur in Manitoba where they have been used as a source of natural cement raw material.

AGGREGATES

Sand and gravel deposits are, for the most part, intimately related to the history of glaciation, deglaciation and postglacial geomorphic processes throughout Saskatchewan. Proglacial deposits, including outwash plain, deltaic, valley train and meltwater stream, and postglacial alluvial terrace and channel deposits tend to be very large and occasionally very coarse (Mollard and Mollard, 1987). Smaller deposits are associated with kames, kame deltas, kame terraces, eskers and crevasse fillings. Ice-contact deposits are usually small, more abundant and more variable and complex. Of local significance, specifically in south-central and southwestern Saskatchewan, are the coarse and highly rounded Tertiary quartzite gravels of the Eocene-Oligocene Swift Current and Cypress Hills Formations and the Miocene Wood Mountain Formation. Reworked equivalents of these formations provide material for either direct use or

TABLE 3
AVERAGE SIZE DISTRIBUTION AND ANALYSES
OF SAND FROM THE RED DEER RIVER DEPOSIT

Mesh Size	Av. %	Av. SiO ₂ %	Av. Kaolin %
-18+35	25.7	98.95	0.72
-35+60	37.01	98.96	0.84
-60+100	25.00	98.49	1.30
-100+200	5.49	95.64	2.02

as crushed material in concrete aggregate, road surfacing material, exposed concrete aggregate and stucco aggregate.

Mollard and Mollard (1987) indicate, on the basis of about 10 000 gravel prospects mapped from airphotos in the past 40 years, that there is about one small sand and gravel prospect for every 26 square kilometres and about one large prospect for every 2 600 square kilometres investigated. Most of the larger deposits range from 2.5 million to 12.7 million tonnes. The largest contains about one billion tonnes. The relative abundance, ease of discovery and widespread occurrence of sand and gravel deposits throughout much of Saskatchewan have resulted in a paucity of published data on resources. The earliest are those of the Geological Survey of Canada from 1916 to 1920. Some of the most significant with respect to sand and gravel resource location are those by E.A. Christiansen between 1956 and 1970 on glacial and surficial geology, groundwater, preglacial valleys and Pleistocene stratigraphy. Geotechnical engineering and geological consulting firms, rural municipalities, private contractors and the provincial highway construction authorities have made considerable contributions to sand and gravel resource location, development and supply. However, few of the data are published. The Saskatchewan Research Council has embarked on a long-term aggregate resource evaluation program. Maps being published under the program are 1:250 000 scale surficial geology and aggregate resource potential maps and 1:50 000 scale aggregate resource maps for areas around urban centres. Some of this work was funded by the Canada-Saskatchewan Mineral Development Agreement.

Glaciolacustrine clays in the Regina and Saskatoon areas are used for the production of expanded lightweight aggregate by the rotary kiln method. It is likely that many of the numerous glaciolacustrine clays throughout the province are suitable for this purpose. Bloating temperatures of material from Unity, Swift Current and Sutherland (Saskatoon) range from about 1038 to 1093°C (1900-2000°F). Bulk density of the fired product ranges from 514 to 770 kilograms per cubic metre (32 to 48 lbs/ft³) and water absorption (3-day soak) ranges from 1 to 5 per cent (Sacuta, 1956).

CEMENT

Inland Cement Limited, a subsidiary of the CBR Group, is the sole producer of cement in Saskatchewan. Limestone and gypsum are transported by rail to the Regina plant from quarries in Manitoba.

Clay is derived from local deposits and silica sand is trucked in from Pilot Butte, several kilometres east of the plant. The raw materials, including mill scale from the

IPSCO steel mill in Regina are mixed prior to firing and ground to a fineness of 80 per cent passing through 200 mesh. Cement products include Normal Portland (Type 10), High-Early (Type 30), masonry cement and oilwell cement. The Inland Cement plant capacity is over 220 000 tonnes per year, nearly all of which is marketed in Saskatchewan and some in western Manitoba and Northern United States.

Canada Cement Lafarge Ltd. operates a clinker grinding plant at Floral, near Saskatoon. Types I and V clinker are obtained from the company's cement plants at Fort Whyte, Manitoba and Exshaw, Alberta. The products, normal Portland and sulphate-resistant cements are marketed mainly in northern Saskatchewan and northeastern Alberta. The plant capacity is about 225 000 tonnes per year (Guliov, 1984).

SILICA SAND

High grade silica sand deposits in Saskatchewan occur in the Lower Cretaceous Mannville and the Ordovician Winnipeg Formations. Major resources of Cretaceous Mannville silica sand were reported by Babey (1955) in the Red Deer River area. About 10 metres of section is visible in cliffs and bluffs flanking the river. Babey's work from 1955 indicates the silica content of the raw material ranges from 97.4 to 98.5 per cent and for washed and tumbled material from 99.0 to 99.6 per cent.

Grain sizes range from 77.4 to 86.9 per cent in the minus 20 plus 65 mesh size range. More recent analytical results are shown in Table 3.

Trommeling of one sample from the -35+60 mesh fraction increased the silica content from 98.93 per cent to 99.48 per cent. Resources in the immediate area of the outcrops along Red Deer River are estimated at about 14 million tonnes with thin overburden.

Early Cretaceous silica sand resources also occur in the region extending from Wapawekka Lake to the Bow River south of La Ronge and eastward to the Nipekamew River area. Deposits are best exposed along the Nipekamew River about 2 kilometres south of Highway 166 where 12 to 18 metres the unconsolidated to semiconsolidated sand and 5 metres of overburden form prominent cliffs. The section consists of a largely

TABLE 4
AVERAGE SIZE DISTRIBUTION AND ANALYSES
OF SAND FROM THE NIPEKAMEW RIVER SITE

Upper Unit (9 samples)

Mesh Size	Av. %	Av. SiO ₂ %	Av. Kaolin %
-5+10	9.7	98.62	1.25
-10+18	14.4	98.74	1.15
-18+35	25.4	98.35	1.55
-35+60	19.3	97.33	2.50
-60+100	10.2	95.60	3.70

Lower Unit (3 samples)

-60+100	32.7	99.56	0.53
-100+200	41.8	98.31	1.58
-200	11.5	62.29	39.10

coarse-grained upper unit 9 metres thick and a partially exposed fine-grained lower unit 3 metres thick.

Overburden thickness at the site is about 5 metres thick. Average particle size distribution and analyses of sand from the Nipekamew River site are presented in Table 4.

Trommeling of one sample from the -35+60 mesh fraction increased the silica content from 98.34 to 99.03 per cent.

The sand beds apparently extend over a large area. They are at surface along the south shore of Wapawekka Lake and along the Bow River about 19 kilometres west of the Nipekamew site. Nine grab samples taken from the Bow River site range from 67 to 88 per cent in the minus 8 plus 65 mesh size. Plus 8 mesh size material varies from about 1 per cent to 23 per cent. Chemical analyses of sands from the Bow River site range from about 96.75 to 98.5 per cent SiO₂ and 1.5 to 3.0 per cent R₂O₃.

While the sands in the region are not well known geologically, the potential for vast upgradeable resources, and their proximity to roads make them an interesting prospect for further evaluation.

Silica sand of the Ordovician Winnipeg Formation is exposed in the Hanson Lake-Limestone Lake area, often as outliers, many of which are capped by dolomite. Maximum observed sand thickness is about 5 metres. Textural analyses presented by Byers (1957), indicate about 86 per cent or more is in the plus 60 mesh range. The coarser grains have a high degree of sphericity and roundness. Chemical analyses indicate a silica content of 98.8 to 99.6 per cent and R₂O₃ of 0.29 to 0.87 per cent. The Winnipeg sand is equivalent to the Black Island sand produced in Manitoba for glass manufacturing. In addition to its potential in the glass and foundry industries its high grain sphericity may present an opportunity for use as a hydraulic fracturing and propping medium.

Currently Hudson Bay Mining and Smelting Co. Ltd., produces silica sand for use as a smelter flux at the copper-zinc operation in Flin Flon. Red Deer Silica Inc. operates a screening and washing facility at a quarry northeast of Hudson Bay and produces golf course sand.

VOLCANIC ASH

Crawford, (1955) described five of the largest pumicite (volcanic ash) deposits in Saskatchewan. The three most significant are:

- Duncairn deposit along Swift Current Creek about 30 kilometres southwest of Swift Current

- Rockglen deposit located about 6 kilometres west of Rockglen and
- St. Victor deposit about 1 kilometre northeast of St. Victor.

Resources in the Rockglen deposit are estimated to be in excess of 1.8 million tonnes. The Eocene-Oligocene deposits (of rhyolitic composition) at Duncairn and Rockglen are the largest, purest and of finest grain size. From 90 to 98 per cent of the material is of minus 200 mesh size.

Crawford (1955) indicated the principal uses of the volcanic ash include abrasives, mineral wool, pozzolan and as a replacement of feldspar in ceramic glazes.

Giordano et al. (1987) conducted successful experimental hydrothermal synthesis of zeolites from pumice, perlite and tuff with SiO₂/Al₂O₃ molar ratios of 9.5, 7.3 and 5.1 respectively. They indicated that a high initial molar ratio of SiO₂/Al₂O₃ and a relatively low level of ancillary minerals promote more complete and rapid conversion. With the exception of a somewhat higher iron content, Saskatchewan pumicite is similar to that used in the experimental work. Molar ratios of SiO₂/Al₂O₃ in the Duncairn, Rock Glen and St. Victor pumicite are 9.3, 8.1-8.4 and 7.9-8.5 respectively, sufficiently high to consider zeolite synthesis. Zeolites produced from a low iron precursor are of higher value and find use in detergents and the filler industry. Those with a higher iron content are of lower value but have a wider range of applications such as ion-exchange in aquaculture, agriculture, horticulture and water and waste treatment; desiccants; gas absorptions; heat storage and solar refrigeration; animal nutrition; pozzolanic cements, etc. (Giordano et al., 1987).

ORGANICS

PEAT

Saskatchewan's major peatlands extend over about 4 million hectares in the region bordering the southern margin of the Precambrian Shield (Scott, Korpijaakko and Tibbetts, 1980). The first regional investigation of peat resources in Saskatchewan was conducted by Troyer (1985). The investigation concentrated on the peatlands of the Buffalo Narrows-Beauval area and the Pinehouse-La Ronge lowlands.

Guliov and Troyer (1981) reported that the peatlands of the Buffalo Narrows-Beauval region tend to be flat, extensive and shallow (1.5-3 metres). The majority are of the sedge type with high water tables and eutrophic

TABLE 5
TYPICAL AVERAGE ANALYSES OF SASKATCHEWAN FUEL PEAT

	La Ronge	Pinehouse	Buffalo Narrows	Beauval
Moisture (% wet wt.)	91.1	89.8	89.7	89.1
Organic Matter (% dry wt.)	89.1	86.4	90.7	90.7
Ash %, dry	10.9	13.6	9.3	9.3
Bulk Density Kg/m ³ at 50% H ₂ O	195	232	-	-
Volatile %, dry	64.1	61.4	65.2	65.8
Heat Value (dry), K Cal/kg	4896	4589	4842	4889
Sulphur %	0.51	0.43	0.19	0.24

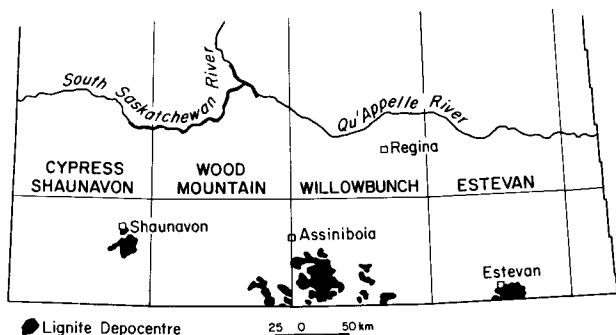

Figure 9. Lignite resource areas and depocentres in southern Saskatchewan.

conditions. Commonly a thicker well-humified sedge peat is overlain by a thin cover of poorly humified sphagnum peat. Average peatland areas range from 80 to 300 hectares, from region to region. Some individual bogs exceed 3000 hectares. The larger peatlands tend to be fens.

Peatlands of the La Ronge-Pinehouse lowlands are largely of the sphagnum type. Humification is less well advanced than in more westerly bogs, although locally it is quite well advanced (H4+). Bog areas are highly variable and range upward to several thousand hectares. Typical fuel peat analyses in four of the western peatland areas are shown in Table 5.

In addition to horticultural moss, peat production Saskatchewan peatlands are significant in their potential for displacing heating oil in northern communities and in the ability of some of the larger bogs to supply thermo-electric generating facilities (Troyer, 1985). The application of peat to individual or district domestic heating will probably depend on the production of a low cost fuel in conjunction with other major development such as peat-fueled thermoelectric generation. Future prospects for Saskatchewan fuel peat resources also include wet carbonized peat fuel, peat briquettes, peat coke and organic derivatives.

Peat development in Saskatchewan is presently restricted to horticultural peat moss production by Premier Sask. Inc. in the Carrot River area. Raw peat for the plant is supplied from bogs near Carrot River and Tobin Lake. Approximately 750 000 bales were produced in 1988.

LIGNITE, LEONARDITE

The Paleocene Ravenscrag Formation hosts all economically mineable lignite resources in Saskatchewan. The formation represents the northern limit of an extensive Tertiary basin centered in Montana and North Dakota and extends over an area of about 26 000 square kilometres in the southernmost parts of the province. Formation thickness ranges from about 76 metres in the southwest to about 300 metres in the southeast where it occupies the northern portion of the Williston basin. Overburden of younger Tertiary, or Quaternary sediments varies from very thin or absent to over 100 metres thick.

Economically mineable lignite resources occur in four areas: Estevan, Willow Bunch, Wood Mountain and Cypress - Shaunavon (Figure 9).

Irvine et al. (1978) identified 5 upper and 14 deeper zones in the Estevan area, 6 each in the Willow Bunch and Wood Mountain areas and 2 in the Cypress - Shaunavon area. Estimated resources of about 7.6 billion tonnes are distributed as follows:

Estevan area	16%
Willow Bunch area	42%
Wood Mountain area	28%
Cypress - Shaunavon area	14%

Saskatchewan Power Corporation, (1984), summarized the variation in lignite properties as follows:

	Estevan	Willow Bunch*	Cypress
Moisture %	37.5	39.5	40.9
Ash %	9.1	13.7	17.5
Volatile Matter %	24.6	23.7	21.5
Fixed Carbon %	28.8	23.1	20.1
Calorific Value (KJ/kg)	15 100	12 235	10 642
Sulphur %	0.3	0.5	0.3

*similar for Wood Mountain

Lignite mining presently is centred in the Estevan and Willow Bunch areas. Production from five mines has reached about 12 million tonnes annually. About 80 per cent of the lignite is utilized in-province for power generation. Nearly 20 per cent is exported for thermal-electric generation and a small amount is used for lignite char and barbecue briquette production. Key elements in the future growth of the industry will be:

- growth of demand for electrical power,
- upgrading lignite for eastern Canadian markets, and
- implementation of technology relating to coal liquefaction, gasification and coal-water fuel.

Lignite beds occurring in the shallow subsurface are susceptible to weathering or alteration by air penetration or by oxidizing ground water. A common product of weathering is a substance known as leonardite. In the moist state leonardite is a soft, greasy, rubbery, black or deep brown material occurring in association with the lignite deposits. In the dry state it may be very tough and waxy.

Leonardite has a high but variable oxygen content ranging from 30 to 60 per cent compared with less than 25 per cent for lignite. Also characteristic of leonardite is the high base-soluble humic acid content in the form of humates and fulvates. Humic acid content may, in some cases be close to 100 per cent but usually ranges between 40 and 85 per cent combined humates and fulvates. O'Donnell (1970) presented the comparative analytical data shown in Table 6.

Leonardite deposits extending over several tens of hectares have been exposed during lignite mining in the Estevan and Willow Bunch coalfields. Other occurrences have been reported in the areas of Pinto, Hitchcock, Limerick and Roche Percée.

There is no commercial production of leonardite in Saskatchewan currently. Some of the more significant uses of the material include:

TABLE 6
CHEMICAL ANALYSES OF SASKATCHEWAN LIGNITE AND LEONARDITE

	<u>Lignite</u>	<u>Leonardite</u>
Ash Content	10.0	18.7
Ultimate Analysis (moisture and ash-free)		
Carbon	73.8	63.9
Hydrogen	5.1	4.0
Oxygen	19.9	28.4
Nitrogen	1.2	1.2
Sulphur	1.0	2.5
% Humic Acid Extracted	5.0	84.3

- soil conditioning and horticultural applications as a root stimulant
- drilling mud additive as a peptizing agent
- wood staining

GEM MATERIALS

DIAMONDS, SAPPHIRE, BERYL

The recent discovery of a kimberlitic body near Sturgeon Lake about 32 kilometres northwest of Prince Albert has generated great interest in the diamond potential of the region. A second discovery a few kilometers from the first was reported by Corona Corporation to be diamondiferous. Many other targets in the region have been identified by industry. Uranerz Exploration and Mining has reported several pipes in the Fort-a-la-Corne area, 70 kilometres east of Prince Albert and the discovery of four macrodiamonds, the largest of which is nearly 4 millimetres in diameter.

Parameters controlling the emplacement of kimberlite pipes in Saskatchewan are not well understood at present. Significant elements in an exploration rationale in the sedimentary basin are identification of Precambrian basement structures, especially major faults and sub-cratonic block margins, geochronological determinations of known kimberlites, and a better understanding of glacial and postglacial dispersion of indicator minerals. Important primary exploration techniques include air and ground magnetic surveys, gravity surveys and indicator mineral sampling.

The emplacement of the Sturgeon Lake kimberlite is inferred to have taken place during Late Cretaceous time or later. However there is no reason to believe that earlier similar events have not taken place. For the present, until much more is understood about the structural and tectonic history of the basement and the Phanerozoic cover, the entire sedimentary basin appears to be prospective ground. Kimberlites have also been found in the Precambrian Shield. Consequently exploration efforts could become far more widespread than originally expected.

Indicator mineral studies conducted in the Big Muddy Valley area of Southern Saskatchewan have revealed the presence of sapphire grains. The occurrences present the possibility of local intrusive deposits similar to the sapphire-bearing Yogo Lamprophyre in central Montana.

Beryliferous pegmatites in the Amisk Lake (63L)

and Pelican Narrows (63M) areas have been recorded as early as 1964. Those occurring in the Hanson Lake-Jackpine Lake area (63L-10 & 15) are of particular interest due to their abundance, large size and higher beryl content. MacDougall (1989) reported beryl as single euhedral hexagonal crystals up to 50 millimetres in diameter and up to 100 millimetres long. Colors are mainly apple green but are also golden brown, pale green, whitish green and white or bluish green. MacDougall (1989) also reported that some of the beryl is translucent to transparent suggesting the possibility of gem quality material. More detailed examination of the area is recommended.

OTHERS

MANGANESE

The basal beds of the Late Cretaceous Riding Mountain Formation in the Pasquia Hills region contain several horizons rich in manganosideritic nodules. Beck (1974) conducted field mapping in the area and noted their occurrence along the Waskwei, White Poplar and Bainbridge Rivers and in several canyons along the northwest scarp as far as the Man River. The nodules commonly occur in layers one nodule thick along bedding planes. They are generally sub-rounded, ovoid or discoid and range in thickness from 2.5 to 10 centimetres

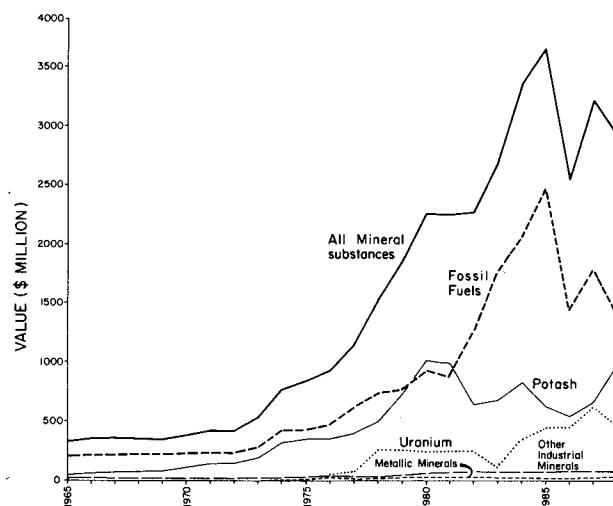

Figure 10. Historical summary of mineral sales value in Saskatchewan.

TABLE 7
SUMMARY OF INDUSTRIAL MINERALS DEVELOPMENT IN SASKATCHEWAN

<u>COMMODITY</u>	<u>LOCATION MINE/QUARRY/PLANT/DEPOSIT</u>	<u>COMPANY</u>	<u>REMARKS</u>
<u>SALTS AND BRINES</u>			
Potash	Saskatoon (PCS, Cory Division)	Potash Corporation of Saskatchewan	Also operates K ₂ SO ₄ pilot plant Produces some CaCl ₂ brine
	Lanigan (PCS, Lanigan Division)	Potash Corporation of Saskatchewan	
	Rocanville (PCS, Rocanville Division)	Potash Corporation of Saskatchewan	
	Allan (Allan Potash Mine)	APM Operators Ltd. (PCS & Saskterra Fertilizers Ltd.)	
	Vanscoy (Cominco Potash Mine)	Cominco Ltd., (Potash Division)	
	Patience Lake (Patience Lake Mine)	Potash Company of America (Rio Algom)	Flooded in 1987; Converted to solution mine
	Colonsay (CCP Mine)	Central Canada Potash Company Limited	
SODIUM SULPHATE	Esterhazy (K-1 & K-2 Mines)	International Minerals & Chemical (Canada) Corporation Limited and PCS Esterhazy Division	Also produces road salt
	Belle Plaine (Kalium Mine)	Kalium Chemicals Limited (Sullivan & Proops)	Solution mine
	Palo (Whiteshore Lake)	Millar Western Industries	Salt cake
	Alsask (Alsask Lake)	Francana Minerals Limited	Salt cake and detergent grade Indefinite closure April 27/91
	Cabri (Snakehole Lake)	Francana Minerals Limited	
	Cabri (Verlo Lake)	Francana Minerals Limited	Salt cake Indefinite closure May 4/91
	Chaplin (Chaplin Lake)	Dickenson Mines Ltd.	Processing at Snakehole plant operation ceased
	Fox Valley (Ingebright Lake)	Dickenson Mines Ltd.	Salt cake and detergent grade (1986)
	Ormiston (Shoe Lake)	Ormiston Mining and Smelting Company Limited	Salt cake
	SALT	Unity (solution mining)	Sifto Canada Inc.
Saskatoon (solution mining)		Saskatoon Chemicals Division of Meyerhaeuser Canada Ltd.	Caustic soda, chlorine, sodium hypochlorite, hydrogen and HCl
Belle Plaine		Canadian Salt Company Limited	Utilizes by-product brine from Kalium Chemicals Limited potash mine for fine vacuum pan salt, livestock salt, ice-control salt
CALCIUM CHLORIDE	Esterhazy (K-1 & K-2 mines)	International Minerals & Chemical (Canada) Corporation Limited	Road salt produced as by-product of potash mining
	Saskatoon (PCS Cory Division)	Potash Corporation of Saskatchewan	28% CaCl ₂ brine
<u>CLAY PRODUCTS</u>			
CLAY - ceramic	Estevan, Rockglen and Readlyn	Estevan Brick Ltd. (Division of Thunderbrick Ltd.)	Structural and face brick
	Regina, Claybank and Eastend	I-XL Industries Ltd. (Western Clay Products Division)	Sewer pipe, flue linings, brick
	Regina	Inland Cement Industries Limited	Local clay used in Portland cement production
	Ravenscrag	Plainsman Clay Ltd.	Stoneware clay quarried near Ravenscrag and processed at Medicine Hat, Alberta
CLAY - bentonite	Quarry - Truax Plant - Wilcox	Canadian Clay Products Inc.	Commenced operation in early 1991 previously operated under Avonlea Mineral Industries Ltd.
CLAY - bloating	Plants - Saskatoon, Regina	Cindercrete Products Ltd.	Glacial lake clays used for production of lightweight expanded aggregate
<u>BUILDING MATERIALS</u>			
AGGREGATE	Scattered throughout Province	Numerous producers (crown & freehold)	
CEMENT	Regina	Inland Cement Industries Limited	Uses local clay, imported limestone and local mill scale for types I and V portland and masonry cement
	Floral	Canada Cement Lafarge	Grinding plant only
<u>ORGANICS</u>			
PEAT MOSS	Carrot River (plant) Bogs in Carrot River and Tobin Lake areas	Premier Sask. Inc.	Horticultural peat. New plant to be built in 1990 near Carrot River. New bogs to open up.
<u>OTHER</u>			
SILICA SAND	Amisk Lake Area	Hudson Bay Mining and Smelting Co. Ltd.	Silica used in Cu-Zn smelter (Flin Flon)
	Red Deer River (N.E. of Hudson Bay)	Red Deer Silica Inc.	Producing golf course sand
Sulphur (by-product)	Regina	Consumer Co-op Refinery (Heavy oil upgrader)	200-250 t/d by-product

and occasionally up to 15 centimetres. Diameters as reported by Beck (1974) are from 5 centimetres to 15 centimetres and occasionally in excess of 50 centimetres.

Six analyses indicate the nodules contain iron ranging from 17.54 to 21.95 per cent and manganese ranging from 12.54 to 22.45 per cent. The iron and manganese are present as carbonates with quartz, calcite and various trace elements.

Beck (1974) calculated a potential maximum tonnage of 5 to 6 million tons of nodules assuming a stripping ratio of 0.5 waste to 1.0 ore, an average bed thickness of 30 feet (9 metres), a grade of one ton nodules per 400 cubic feet of shale and continuity of the nodule horizons around the scarp edge of the hills between Waskwei and Man Rivers.

Recent analyses of some manganese nodules from the Pasquia Hills reveal anomalously high values of some rare elements:

cesium	92 ppm
neodymium	40 ppm
samarium	7.5 ppm
germanium	10 ppm
tin	54 ppm
lanthanum	47 ppm
platinum	10 ppm
uranium	7.5 ppm
silver	6 ppm

OTHER INDUSTRIAL MINERALS

A wide variety of other industrial minerals occur in the province. As markets expand and traditional sources become depleted many of them will likely be targets for further investigation and possible development. While some of the minerals listed below fall within major categories previously discussed they are grouped separately in a poorly documented category requiring further investigations. The most significant are presented in the following summary:

PRECAMBRIAN

Soapstone	Lac la Ronge, Wapawekka Lake
Marble	Stanley Mission area
K-Feldspar	La Ronge, McLennan Lake areas
Quartzite	Sandfly Lake area
Graphite	Deep Bay (Reindeer Lake)
Rare Earths	Uranium City area, Nisikkatch-Hoidas Lakes area
Magnesite	Mosher Lake
Phosphate	Athabasca Lake (south shore)

PHANEROZOIC

Elemental Sulphur	Devonian, west-central Saskatchewan
Gypsum	Devonian, Egg Lake area
Leonardite (humic acid-rich oxidized lignite)	south Saskatchewan lignite fields
Ochre	Makwa Lake
Marl	Sturgeon Lake

SUMMARY OF DEVELOPMENT

Industrial mineral development in Saskatchewan has experienced a slow growth rate from the late 1800s to about 1969. Accelerated growth and periods of fluctuations in industrial mineral sales value since 1969 has been due largely to the development of the potash industry (Figure 10). Presently the dominant industrial minerals in terms of value of sales are potash, sodium sulphate, granular aggregate and salt. Potash is by far the dominant of this group, contributing about 93 per cent of all industrial mineral sales value over the past two decades.

In addition to potash the industry produces sodium sulphate, salt, calcium chloride brine, clay products, aggregate, cement, peat moss, silica sand and by-product sulphur. These are summarized in Table 7. The potential for new development appears to be high for subsurface calcium and magnesium brines, clay products (particularly kaolin and bentonite), building stone and silica sand. Although it is too early to speculate on the developmental potential for a diamond industry exploration results are very encouraging and the prospect for discovering an economic pipe is increasing.

REFERENCES

- Babey, W.J. (1955): The Red Deer River Silica Sand Deposits of East Central Saskatchewan; *Saskatchewan Department of Mineral Resources*, Report of Investigations, Number 7, 29 pages.
- Barry, G. (1988): Sodium Sulphate; in Canadian Minerals Yearbook 1987, Review and Outlook, *Energy, Mines and Resources Canada*, Mineral Report 36, pages 59.1-59.6.
- Barry, G.S. (1981): Potash; in Canadian Minerals Yearbook 1979, Mineral Report 29, *Energy, Mines and Resources Canada*, pages 349-363.
- Beck, L.S. (1974): Geological Investigations in the Pasquia Hills Area; *Saskatchewan Department of Mineral Resources*, Report Number 158, 16 pages.
- Brock, G. (1990): Larger Diamonds Turn up near Melfort; *The Leader Post*, Nov. 9, 1990, page B11.
- Buchinski, K.W. (1988): Recovery and Commercial Application of Calcium Chloride Brine; CIMM 90th Annual General Meeting, Edmonton, Paper Number 22.
- Byers, A.R. (1957): The Geology and Mineral Deposits of the Hanson Lake Area, Saskatchewan; *Saskatchewan Department of Mineral Resources*, Report Number 30, 47 pages.
- Caldwell, W.G.E. (1982): The Cretaceous System in the Williston Basin - a Modern Appraisal; in *Fourth International Williston Basin Symposium*, pages 295-312.
- Crawford, G.S. (1955): Pomicite in Saskatchewan; *Saskatchewan Department of Mineral Resources*, Report Number 16, 35 pages.
- Davis, N.B. (1918): Report on the Clay Resources of Southern Saskatchewan; *Canada Department of Mines*, Mines Branch, Report Number 468, 93 pages.
- Dunn, C.E. (1975): The Upper Devonian Duperow Formation in Southeastern Saskatchewan; *Saskatchewan Department of Mineral Resources*, Report Number 179, 151 pages.
- Dyck, J.H., McKenzie, C.T., Tibbetts, T.E. and Whitaker, S.H. (1979): Quality and Occurrence of Coal in

- Southern Saskatchewan, Canada, Volume 1, Introduction to Data Acquisition and to Associated Computer Processable Files; *Saskatchewan Research Council*, project under Canada DSS file No. 19SQ.23440-8-9015.
- Fuzesy, Anne (1984): Potash in Western Canada; in *The Geology of Industrial Minerals in Canada*, *Canadian Institute of Mining and Metallurgy*, Special Volume 29 pages 188-194.
- Fuzesy, L.M. (1980): Geology of the Deadwood (Cambrian), Meadow Lake and Winnipegosis (Devonian) Formations in West-central Saskatchewan; *Saskatchewan Mineral Resources*, Report Number 210, 64 pages.
- Giordano, N., Recuperero, V., Pino, L. and Bart, J.C.J. (1987): Zeolitisation of Perlite, A Prospective Route; *Industrial Minerals*, September, pages 83-95.
- Guliov, P. and Troyer, D.R. (1981): Potential for Fuel Peat Heating in Northern Communities of Saskatchewan; in *Summary of Investigations 1981*, Saskatchewan Geological Survey, *Saskatchewan Mineral Resources*, Miscellaneous Report 81-4, pages 167-176.
- Guliov, P. (1984): Summary of Industrial Minerals in Saskatchewan; in *The Geology of Industrial Minerals in Canada*, Special Volume 29, *Canadian Institute of Mining and Metallurgy*, pages 201-208.
- Guliov, P. (1987): Industrial Minerals of Southern Saskatchewan; GAC-MAC Joint Annual Meeting, Guidebook, Field Trip 5, 50 pages.
- Holter, M.E. (1969): The Middle Devonian Prairie Evaporite Formation of Saskatchewan; Saskatchewan Department of Mineral Resources Report Number 123, 133 pages.
- Hudson, J.H. (1984): Ceramic Clays and Bentonites of the Prairie Provinces; in *The Geology of Industrial Minerals in Canada*, Special Vol. 29, *CIMM*, pages 184-187.
- Irvine, J.A., Whittaker, S.H. and Broughton, P.L. (1978): Coal Resources of Southern Saskatchewan: A Model for Evaluation Methodology; *Saskatchewan Department of Mineral Resources*, Report 209, pt I 156 pages, pt II (atlas) 56 plates.
- Keele, J. (1915): Clay and Shale Deposits of the Western Provinces (Part V); *Geologic Survey of Canada*, Memoir 66, 74 pages.
- Kupsch, W.O. (1952): Ordovician and Silurian Stratigraphy of East Central Saskatchewan; *Saskatchewan Department of Mineral Resources*, Report Number 10, 62 pages.
- Lane, D.M. (1959): Dawson Bay Formation in the Quill Lakes - Qu'Appelle Area Saskatchewan; *Saskatchewan Department of Mineral Resources*, Report Number 38, 49 pages.
- Lane, D.M. (1964): Souris River Formation in Southern Saskatchewan; *Saskatchewan Department of Mineral Resources*, Report Number 92, 72 pages.
- Last, W.M. and Schweyen, T.H. (1983): Sedimentology and Geochemistry of Saline Lakes of the Great Plains; *Hydrobiologia*, Volume 105, pages 245-263.
- Last, W.M. and Slezak, L.A. (1987): Sodium Sulphate Deposits of Western Canada: Geology, Mineralogy, and Origin; in *Economic Minerals of Saskatchewan*, *Saskatchewan Geologic Society of Specialists*, Publication Number 8, pages 197-205.
- MacDougall, D.G. (1989): Beryl Pegmatites in the Jan Lake Area, NTS 63L and 63M; in *Summary of Investigations 1989*, *Saskatchewan Energy and Mines*, Saskatchewan Geological Survey, Miscellaneous Report 89-4, pages 71-81.
- Master, P.P. (1987): Evaluation and Geology of Kaolinized Sediments, Wood Mountain, Saskatchewan; in *Economic Minerals of Saskatchewan*, *Saskatchewan Geologic Society of Specialists*, Publication Number 8, pages 166-181.
- Mollard, J.D. and Mollard, D.G. (1987): Location, Exploration and Production of Gravel Resources in Saskatchewan; in *Economic Minerals of Saskatchewan*, *Saskatchewan Geologic Society of Specialists*, Publication 8, pages 210-215.
- Monea, M.J. (1984): High-Swelling Bentonite Deposits in Southwest Saskatchewan; in *The Geology of Industrial Minerals in Canada*, *Canadian Institute of Mining and Metallurgy*, Special Volume 29, 183 pages.
- Mysyk, W.K. (1985): Ordovician Dolomites in the Deschambault-Limestone Lakes Area of Saskatchewan (63L 11 & 12); unpublished report of investigation conducted for *Energy, Mines and Resources*, Canada under DSS Contract No. OISF, 23230-5-0110.
- O'Donnel, R.W. (1970): The Effects of Coal Derived Humic Compounds on Plant Root Initiation; Report C70-5 Chem Div., *Saskatchewan Research Council*, page 20.
- Ries, H. and Keele, J. (1912): Preliminary Report on the Clay and Shale Deposits of the Western Provinces; *Geological Survey of Canada*, Memoir 24-E, 231 pages.
- Ries, H. and Keele, J. (1913): Report on the Clay and Shale Deposits of the Western Provinces (Part II); *Geological Survey of Canada*, Memoir 25, 105 pages.
- Sacuta, Alec (1956): Light-weight Concrete Aggregate From Saskatchewan Clays; *Saskatchewan Department of Mineral Resources*, Report of Investigation, Number 9, 35 pages.
- Saskatchewan Power Corporation (1984): Saskatchewan Lignite Resource; prepared for *Saskatchewan Energy and Mines* under the Canada-Saskatchewan Heavy Oil/Fossil Fuels Research Program, 49 pages.
- Scott, J.B., Korpijaakko, E.O. and Tibbetts, T.E. (1980): Development of Conversion Factors for Expressing Peat Resource Estimates; in *Peat as an Energy Alternative*, Symposium Papers, *Institute of Gas Technology*, Arlington, Virginia, pages 37-49.
- Simpson, F. and Dennison, E.G. (1975): Subsurface Waste-Disposal Potential of Saskatchewan; *Saskatchewan Department of Mineral Resources*, Report Number 177, 76 pages.
- Thomas, D.J. (1984): Geological Mapping, Star Lake Area (part of NTS 73P-16 and 74A-1); in *Summary of Investigations 1984*, Saskatchewan Geological Survey, *Saskatchewan Energy and Mines*, Miscellaneous Report 84-4.
- Tompkins, R.V. (1953): Magnesium in Saskatchewan; *Saskatchewan Department of Mineral Resources*, Report Number 11, 23 pages.
- Tompkins, R.V. (1954): Natural Sodium Sulphate in Saskatchewan; *Saskatchewan Department of Mineral Resources*, Report Number 6, 71 pages.

- Troyer, D.R. (1985): Peat Resources in Saskatchewan; *Saskatchewan Energy and Mines*, Report 218, 74 pages.
- Walker, T. (1987): Hudson Bay Industrial Minerals Project Summary of 1987, Geological Investigations; *Saskatchewan Energy and Mines*, Mineral Assessment file Number 63D 16-SE-0002, submitted by S.M.D.C.
- Winer, A.A. (1954): Acid Activation of Saskatchewan Bentonites; *Saskatchewan Department of Mineral Resources*, Report of Investigations, Number 4, 29 pages.
- Worcester, W.G. (1950): Clay Resources of Saskatchewan; *Saskatchewan Department of Mineral Resources*, Report Number 7, 198 pages.

GEOLOGICAL SETTING AND DEVELOPMENT AND POTENTIAL OF SELECTED INDUSTRIAL MINERALS IN SOUTHEASTERN BRITISH COLUMBIA

By Stephen B. Butrenchuk

Mountain Minerals Co. Ltd., Lethbridge, Alberta

ABSTRACT

Southeastern British Columbia is well endowed with a variety of industrial minerals that include barite, gypsum, phosphate and silica. The geology and potential for these commodities are discussed briefly. Vein and cavity filling type barite deposits occur in rocks of Proterozoic to Ordovician age. Barite, which has been produced from a number of deposits, is currently produced at the Parson Mine from a vein within the Cambrian Hamhill Formation. Gypsum, which occurs in the Stanford Range within the Devonian Burnais Formation, has a resource potential estimated at 160 million metric tonnes. It is presently being produced from deposits on Windermere Creek and Lussier River. Potentially economic phosphate is present in the Jurassic Fernie Formation within the Fernie Basin. Deposits along the eastern and southeastern margins of the basin are chemically and mineralogically the most suitable for potential development. High purity glass grade silica sand and lump silica are produced from the Ordovician Mount Wilson Quartzite from deposits at Moberly and Nicholson respectively. Reserves of glass sand are in excess of 10 million tonnes, while reserves of lump silica are estimated to be 3 million tonnes.

INTRODUCTION

Southeastern British Columbia contains a variety of industrial minerals that include: magnesite, silica, barite, gypsum and phosphate. There are currently 6 quarries producing 4 different commodities (Table 1) and there is exploration for wollastonite and garnet. This paper examines the geological setting and potential for four of these industrial minerals: barite, gypsum, phosphate and silica.

BARITE

Barite occurs in 3 main deposit types, namely: veins and cavity filling, residual deposits, and bedded deposits.

Vein and cavity filling barite represents most of Canada's and all of British Columbia's production.

Several barite and lead-zinc-barite deposits occur in southeastern British Columbia (Figure 1) within and adjacent to a major structure known as the Belt-Purcell Anticlinorium (Figure 2). This is a broad north-plunging structure in Helikian to Hadrynian rocks that occupies the region between the Rocky Mountain fold and thrust belt and the Kootenay Arc. A number of major faults transect the anticlinorium and may have controlled the deposition of sediments and the formation of the mineral deposits. The majority of barite deposits in this area of the province occur in the Proterozoic Mount Nelson Formation and underlying Dutch Creek Formation or its stratigraphic equivalents. The Middle to Upper Cambrian Jubilee Formation, Lower Cambrian Hamill Formation and Ordovician-Silurian Beaverfoot Formation also host a number of barite occurrences. Most of the barite produced has come from deposits within the Mount Nelson Formation and Lower Paleozoic strata (Figure 3).

Barite deposits in Montana with recorded production are in host rocks of the same age or older host rocks than those in British Columbia. Production in Washington comes from Paleozoic strata, from both bedded-barite and vein deposits.

The Proterozoic Mount Nelson Formation consists of a prominent basal quartzite overlain by a thick succession of dolomite and interlayered argillite. It is underlain by up to 1000 metres of dark grey argillite and slate of the upper Dutch Creek Formation and is unconformably overlain by the Toby Formation conglomerate. Deposits present in the Mount Nelson Formation, such as the Mineral King Mine, appear to have been deformed along with the enclosing strata. Sulphide deposits generally occur in structurally elongated, irregular lenses either in dolomite or in barite gangue (Höy, 1980). Strata of the Lower Cambrian Hamill Formation consist of quartzite

TABLE 1
INDUSTRIAL MINERAL PRODUCTION IN SOUTHEASTERN BRITISH COLUMBIA, 1990

MINE	OWNER	COMMODITY	PRODUCTION (tonnes)
Mt. Brussilof	Baymag Mines Ltd.	magnetite	170 000
Lussier River	Domtar Gypsum Inc.	gypsum	135 000
Moberly	Mountain Minerals Co. Ltd.	silica	90 000
Parson	Mountain Minerals Co. Ltd.	barite	N/A
Nicholson (Hunt)	Bert Miller Contracting Ltd.	silica	36 000
Windermere	Westroc Industries Ltd.	gypsum	410 000

data from Legun, 1991

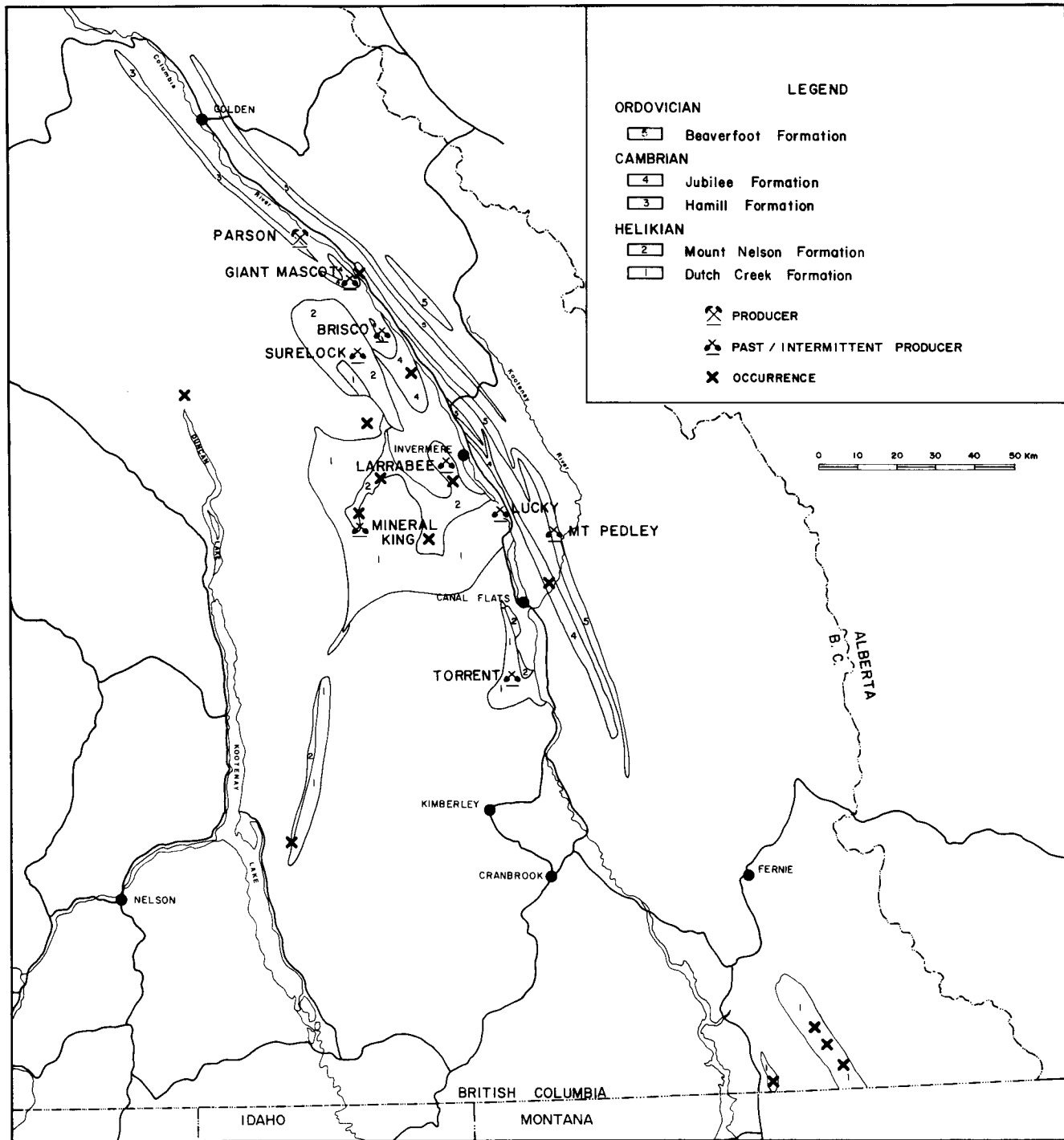

Figure 1. Geological setting of barite deposits in British Columbia.

and quartzose sandstone with lesser amounts of shale, siltstone and sandstones.

The Jubilee Formation consists of a thick succession of massive to thin bedded dolomite and limestone. It overlies argillaceous dolomite and limestone, argillite and argillaceous quartzite of the Eager Formation, and quartzite of the Cranbrook Formation. It is overlain by dark shale and argillaceous limestone of the McKay Group. During Jubilee time shallow-water platformal carbonates developed on the Purcell arch. This structure was intermittently emergent during the Lower Paleozoic.

In the region of the lead-zinc-barite replacement deposits the upper part of the Jubilee Formation comprises a carbonate shoal complex that developed west of a deeper-water shale basin (Höy, 1980). Breccia zones, related to karst development in reefs, appear to be a local ore control.

The Ordovician-Silurian Beaverfoot Formation consists primarily of thin- to medium-bedded, light-grey dolomite and limestone. Ovular chert nodules and lenses in a carbonate matrix are characteristic of this unit.

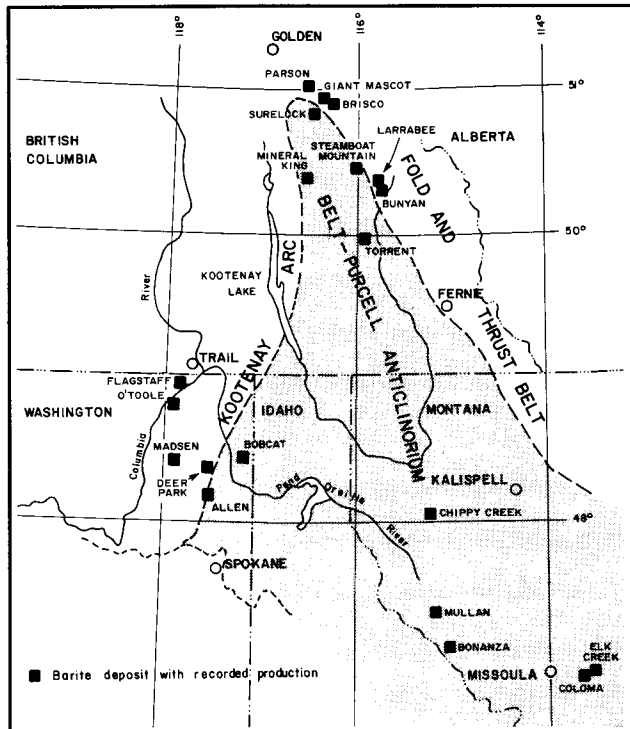

Figure 2. Distribution of barite deposits in relationship to Belt-Purcell Anticlinorium.

Barite in most of the vein deposits is typically dense white to grey, locally siliceous and may contain lead, zinc and copper in trace to minor amounts. In other deposits, such as the Mineral King and Giant Mascot, barite is secondary to lead and zinc. Deposits are typically irregular and vary in size from a few thousand tonnes to over 250 000 tonnes.

Currently, virtually all of British Columbia's barite production comes from Mountain Minerals' mine located at Parson. Barite occurs in several irregular fissure veins which are interpreted as originating with tensile fractures developed between two low angle thrust faults in the lower Cambrian Hamill Formation. The two dominant veins outcrop on surface approximately 100 metres apart. Their strike changes from north along the southern portions of the veins to northwest in the northern portion. Strike length is approximately 300 metres. Dips are west or southwest at 45° near surface and decrease with depth. Several smaller veins are offshoots from and link the two major veins. The barite is white to creamy-white, coarse-grained and locally iron-stained. Minor to trace amounts of hematite, quartz, pyrite, chalcopyrite, siderite and calcite are with barite.

Production of barite has come from the tailings of the Mineral King Mine. It has also been produced from the Brisco, Giant Mascot, Larrabee, Torrent and Mount Pedley deposits. There is minor intermittent production from Baroid's Giant Mascot mine and Bar-Well's Lucky deposit. A very small amount of barite was produced from an exploration adit on Mountain Mineral's newly acquired Surelock property.

GYP SUM

Gypsum ranks third in value of production, behind asbestos and sulphur, among industrial minerals pro-

duced in British Columbia. In 1990, 545 000 tonnes of gypsum were produced from quarries located on Windermere Creek operated by Westroc Industries Limited and on the Lussier River operated by Domtar Construction Materials.

The most extensive gypsum deposits are located in Stanford Range (Figure 4) where there is a resource potential in excess of 200 million tonnes. These reserves are sufficient for more than 200 years based on current production rates.

All of the known gypsum deposits occur within the Devonian Burnais Formation (Figure 5). In addition to gypsum and anhydrite this formation is also comprised of a black fetid limestone and thin grey aphanitic limestone bands. It ranges in thickness from 50 to 300 metres with the thickest sections occurring in the Windermere Creek area. There is a general thinning of the formation southwards toward Coyote Creek where it rarely exceeds 60 metres.

Gypsum throughout the Stanford Range is typically laminar to thin bedded, with laminations and bedding varying in thickness from a fraction of a millimetre to 3 millimetres. Laminations are generally crenulated or intricately folded. The colour of the gypsum varies from white through various shades of grey to occasionally black but pale brown to pale brownish grey laminae are common. White selenite occurs as blebs but also as well-formed crystals or vein filling along fracture and fault surfaces. Cross-laminations and cut-and-fill structures, indicative of periodic high-energy events in an overall shallow-water facies, are observed. Native sulphur is present in trace amounts at many localities, most commonly as crystalline masses associated with selenite along fractures. Occasionally it is smeared along slickensided surfaces giving the impression of greater abundance.

Anhydrite is rarely observed in outcrop. In the Windermere Creek area anhydrite occurs at an average depth of 30 to 40 metres while in the Lussier River area it occurs at a depth of 20 to 25 metres.

Gypsum deposits are best developed in the Windermere Creek area near the northern end of the Stanford Range where thicknesses in excess of 100 metres have

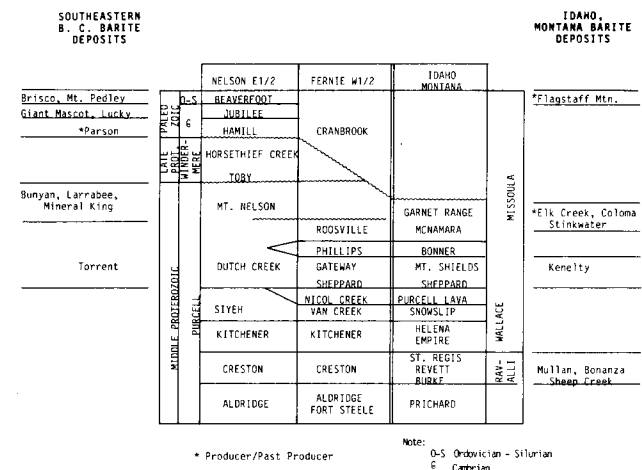

Figure 3. Stratigraphic correlation of barite deposits - British Columbia, Montana and Washington.

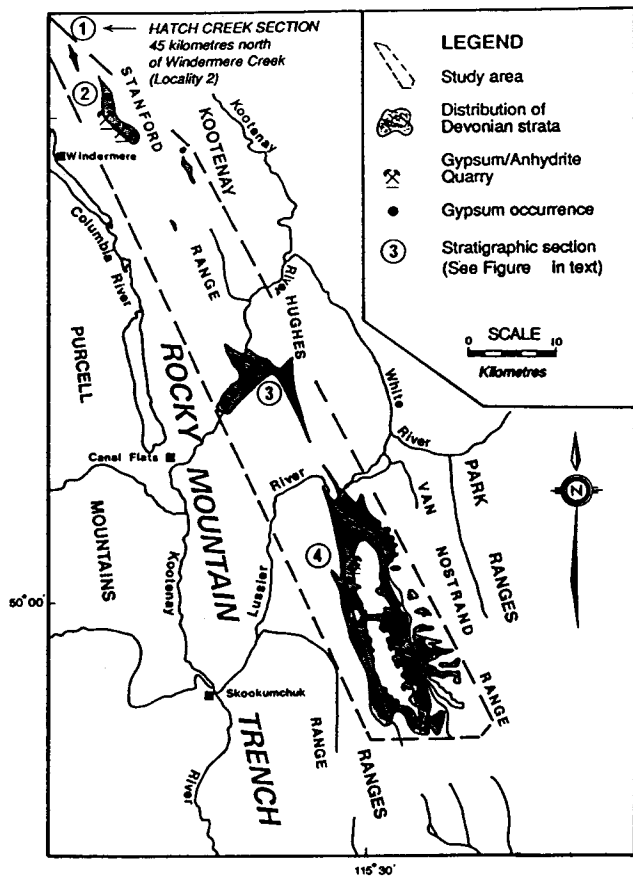

Figure 4. Location map showing the distribution of Devonian strata and gypsum occurrence in the Stanford Range.

been reported. These deposits trend northwesterly along a strike length of 3 kilometres. Two gypsum horizons are interpreted, separated by dolomite and limestone tentatively assigned to the Cedared Formation (Figure 6). The lower gypsum bed has a minimum thickness of 50 metres while the upper bed ranges from 50 to 100 metres thick. The upper bed is structurally more complex and therefore determining an accurate thickness is difficult. Contact relationships between the gypsum and underlying strata were not observed but it is inferred the lower gypsum bed is in fault contact with the underlying Beaverfoot-Brisco Formation. Contacts with the Cedared Formation and overlying Harrogate Formation,

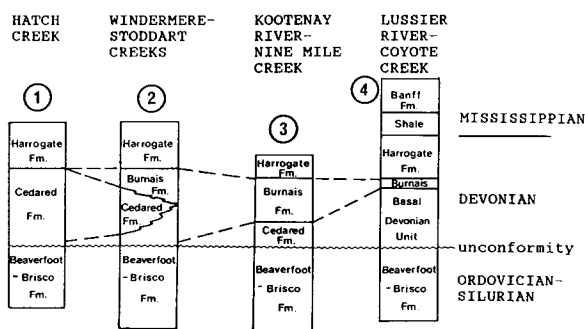

Figure 5. Nomenclature and correlation of Devonian stratigraphy in the Stanford Range.

where observed, appear conformable. The quality of the ore is good, ranging between 83 and 93 per cent gypsum.

Gypsum can be traced northward from Windermere Creek to north of Burnais Creek where it thins and disappears under thick overburden and carbonate strata of the Cedared Formation. Further north a small lens of gypsum outcrops south of Stoddart Creek. Here the rock is of lower quality, containing approximately 75 per cent gypsum (F. W. Jarrett, Westroc Industries Ltd., personal communication, 1988). No gypsum is known to occur north of Stoddart Creek.

At the southern end of the Stanford Range, Domtar's Lussier River gypsum deposit occurs in a northwest-trending anticline (Figure 7). It is truncated on the south by a fault and probably abuts a fault to the

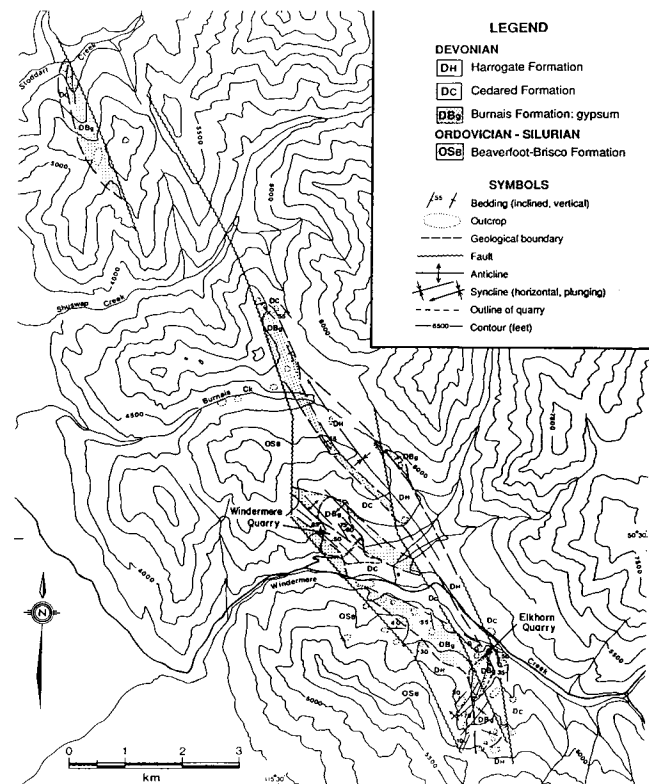

Figure 6. Geological setting of gypsum deposits in the Windermere Creek area, Stanford Range.

north, although evidence for this is lacking. Carbonate strata of the Cedared Formation outcrop immediately north and south of the deposit but nowhere are contact relationships observed. The deposit is overlain by nodular limestone of the Harrogate Formation. Structure within the deposit is complicated by numerous faults with minimal displacement and intricate small-scale folds. A fault with considerable but undetermined displacement near the southern end of the quarry has a carbonate band adjacent to it. These structures are the locus of sinkholes and other karst features.

There are two other significant gypsum occurrences on the east side of the Lussier River, south of the Lussier quarry. The South quarry is a small deposit located 750 metres south of the main producing quarry, but there has been limited production from this locality. Gypsum is

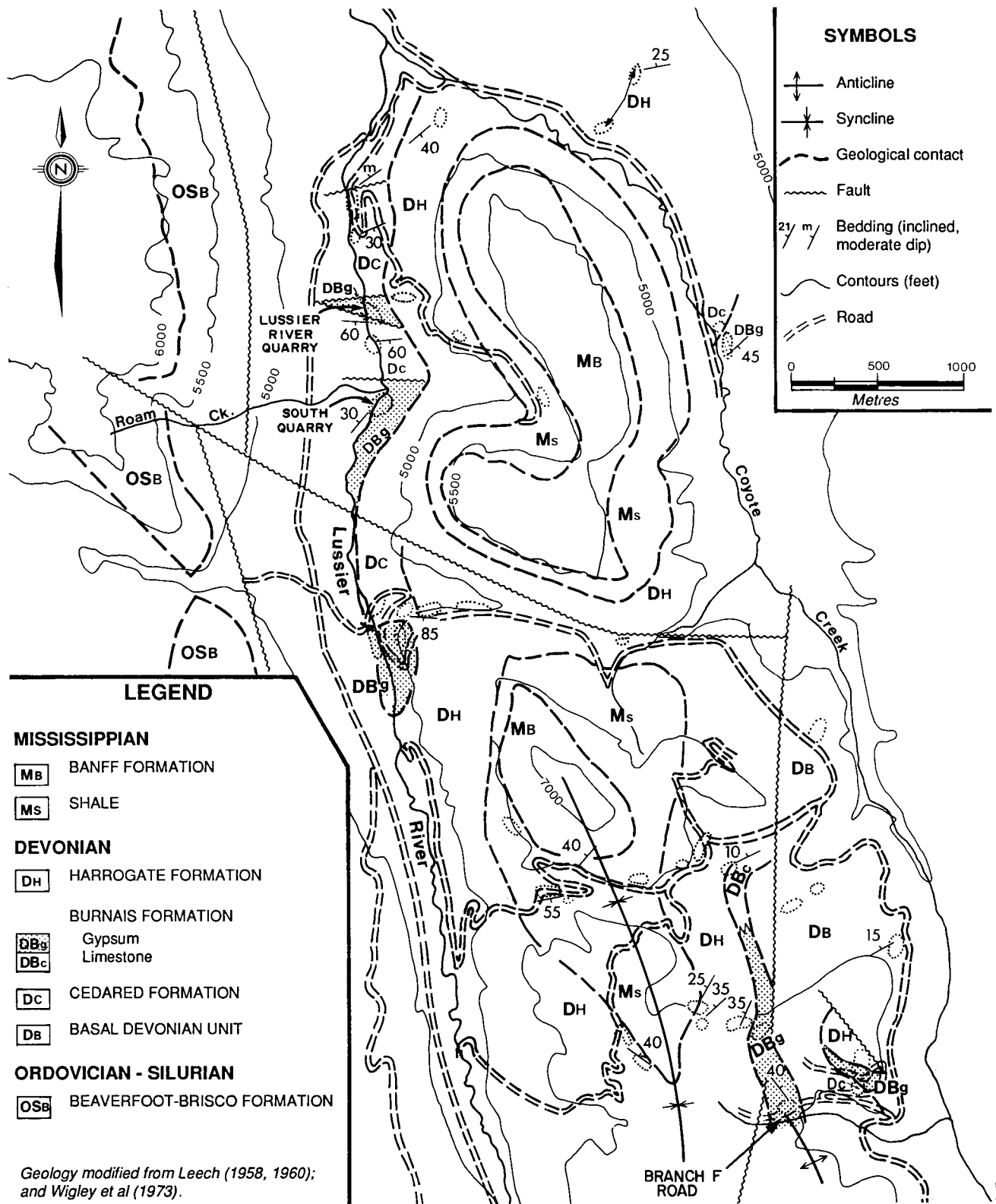

Figure 7. Geological setting of the Lussier River - Coyote Creek area, Stanford Range.

Age	Group/Formation (Thickness, Metres)	Lithology	Phosphate
Cretaceous	Kootenay Fm.	• grey to black carbonaceous siltstone and sandstone; nonmarine; coal	
Jurassic	Fernie Fm. (± 244)	• black, shale, siltstone, limestone; marine to non-marine at top • glauconitic shale in upper section • blemmites common fossil • rare calcareous sandstone • thin conglomerate may be present at base	• basal phosphate in Sinemurian strata; general pellets/oolitic; rarely nodular; 1 to 2 metres thick; locally two phosphate horizons; top of phosphate may be marked by a yellowish-orange-weathering marker bed • approximately 60 metres above base — low-grade phosphate-bearing calcareous sandstone horizon or phosphatic shale
Triassic	Whitehorse Fm.	• dolomite, limestone, siltstone	
	Sulphur Mountain Fm. (100-496)	• grey to rusty brown-weathering sequence of siltstone, calcareous siltstone and sandstone, shale, silty dolomite and limestone	• nonphosphatic in southeastern British Columbia
Permian	Ranger Canyon Fm. (1-60)	• sequence of chert, sandstone and siltstone; minor dolomite and gypsum; conglomerate at base • shallow marine deposition	• basal conglomerate-chert with phosphate pebbles present (≤ 1 metre) • upper portion — brown, nodular phosphatic sandstone; also rare pelletal phosphatic sandstone (few centimetres to + 4 metres)
	Ross Creek Fm. (95-150)	• sequence of siltstone, shale, chert, carbonate and phosphatic horizons areally restricted to Telford thrust sheet • west of Elk River, shallow marine deposition	• phosphate in a number of horizons as nodules and finely disseminated granules within the matrix • phosphatic coquinae horizons present
	Telford Fm. (210-225)	• sequence of sandy carbonate containing abundant brachiopod faunas, minor sandstone • shallow marine deposition	• rare, very thin beds or laminae of phosphate; rare phosphatized horizon
	Johnson Canyon Fm. (1-60)	• thinly bedded, rhythmic sequence of siltstone, chert, shale, sandstone and minor carbonate; basal conglomerate • shallow marine deposition	• basal conglomerate (maximum 30 centimetres thick) contains chert and phosphate pebbles • phosphate generally present as black ovoid nodules in light-coloured siltstone; phosphatic interval ranges in thickness from 1 to 22 metres • locally present as a black phosphatic siltstone
Pennsylvanian	Kananaskis Fm. (± 55)	• dolomite, silty, commonly contains chert nodules or beds	
Mississippian	Rundle Group (± 700)	• limestone, dolomite; minor shale, sandstone and cherty limestone	
Mississippian	Banff Fm. (280-430)	• shale, dolomite, limestone	
Devonian-Mississippian	Exshaw Fm. (6-30)	• black shale, limestone • areally restricted in southeastern British Columbia	• basal phosphate less than 1 metre thick; pelletal • phosphatic shale and pelletal phosphate 2 to 3 metres above base • an upper nodular horizon
Devonian	Palliser Fm.	• limestone	

Figure 8. Stratigraphy of phosphate-bearing formations in southeastern British Columbia.

exposed south of Roam Creek, over a length of 200 metres, in steep bluffs 60 to 90 metres high along the east side of the Lussier River. The gypsum is steeply dipping and cut by numerous near-vertical faults. There is some breccia material and a thin limestone bed adjacent to a fault at the northern end. Traces of native sulphur occur locally. Work by Trurock Gypsum Products Ltd. on this deposit suggests a reserve potential of 40 million tonnes with a gypsum content averaging 80 per cent (Korun, 1980). Large deposits also occur on Coyote Creek and along the Kootenay River, northeast of Canal Flats.

Elsewhere in southeastern British Columbia, low grade gypsum occurs in the Joffre Creek area adjacent to the Alberta boundary, Bull River area and in the Mayook-Chipka Creek areas east of Cranbrook. A small outcropping of gypsum is located east of Nicholson.

PHOSPHATE

Phosphate deposits ranging in age from Late Cambrian to Early Jurassic (Figure 8) occur in a belt along the Rocky Mountains that extends from the United States border to the Yukon. None of these deposits are considered economic.

In southeastern British Columbia, phosphate deposits are best developed in Permian and Lower Jurassic rocks, and the deposits in the Jurassic Fernie Formation offer the best potential for development.

The Fernie Formation occupies a broad canoe-shaped synclinal structure covering 2000 square kilometres in the Fernie basin of southeastern British Columbia (Figure 9). A phosphorite bed, that averages

1.5 metres in thickness, at the base of this unit is traceable for approximately 300 kilometres along strike. It has a resource potential of 57 to 340 million tonnes grading 15 to 20 per cent P_2O_5 . In addition there may be as much as 66 300 tonnes of lanthanum, 44 200 tonnes of cerium, 163 000 tonnes of yttrium and 11 200 tonnes of uranium contained in this phosphorite bed.

The phosphorite bed is pelletal although phosphate nodules may be present. Phosphate pellets composed of fluorapatite are loosely to densely packed, 0.1 to 0.5 millimetre in size, generally well sorted and ovoid. Less than 5 per cent contain internal nuclei. Gangue consisting of calcite and quartz exhibits a crude regional zonation within the Fernie basin. Calcite is dominant in the western portion of the Fernie basin while quartz is dominant along the eastern and southeastern margins. Sericite, illite and montmorillonite are present in trace to minor amounts; dolomite is rare. The gangue is finer grained than the pellets, varying between 0.05 and 0.1 millimetre in size.

The regional zonation of calcite and quartz in the gangue is also reflected in $CaO: P_2O_5$ ratios. Ratios along the eastern and southeastern margins are less than 1.60 whereas those along the western margin of the basin exceed 1.60. The $R_2O_3: P_2O_5$ ratios generally exceed 0.10 and to some extent are indicative of a high clay-sericite content in the phosphorite.

The trace element content of the Fernie phosphorite is variable. Rare earth and yttrium content tends to be above average while the uranium content is lower than that for an average phosphorite. Lanthanum and cerium

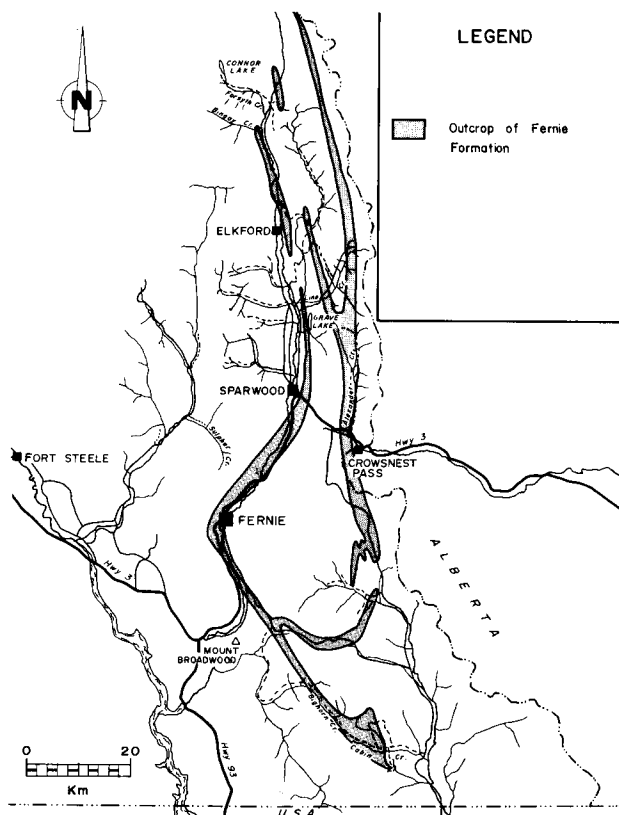

Figure 9. Distribution of Jurassic Formation in southeastern British Columbia.

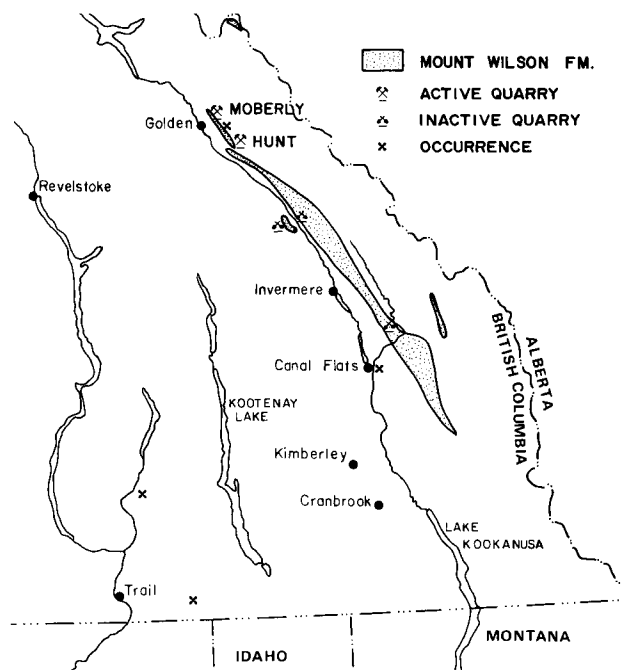

Figure 10. Silica deposits in southeastern British Columbia.

have ranges of 118 to 303 and 67 to 168 parts per million respectively.

Yttrium varies from 312 to 767 ppm and averages 480 ppm, compared to an average of 260 ppm, while uranium varies from 28 to 42 ppm and averages 33 ppm, compared to an average of 120 ppm.

The Fernie Formation phosphate, although not economic at the present time, may be an important source of phosphate in the future. Some problems in beneficiation still have to be resolved. In addition, there is a potential for recovery of rare earth metals.

SILICA

All of British Columbia's silica production comes from two quarries, one is the Moberly property located at Mount Moberly and operated by Mountain Minerals, and the other is the property at Nicholson operated by Bert Miller Contracting Ltd. Production in 1990 from these two operations totalled 126 000 tonnes.

Silica is mined from the Ordovician Mount Wilson Formation. This unit is exposed in a belt that extends from Moberly Peak in the north to southeast of Canal Flats, a distance of 215 kilometres (Figure 10). The thickness of the quartzite varies from one to several hundred metres (Foye, 1987), and there is a general thinning trend southward.

The Mount Wilson Formation is also exposed along the Alberta border north of Golden. However, due to rugged terrain much of this unit is inaccessible.

The quartzite is compact, medium-grained and pure. Locally it is cross-bedded and weathers white to grey and locally it may have a light orange coloration.

At the Moberly mine, operated by Mountain Minerals, silica is quarried from a friable sandstone horizon within the Mount Wilson Formation. This silica-bearing horizon, which is 90 to 200 metres thick at the mine, can

be traced along strike for 350 metres. Bedding strikes north-northwest with dips varying from 75° to vertical. Within the sandstone horizon the silica content is variable. Silica grains consist of two size fractions that average 0.5 and 0.15 to 0.25 millimetres. Grains are rounded quartz grains with some quartz overgrowths. Chemical analyses of the sandstone indicate a SiO₂ content greater than 99.5 per cent with an iron content less than 0.1 per cent. The majority of the silica is used in the manufacture of glass. Other uses include golf course sand, sandblasting and traction sand. Geological reserves are estimated to be 10 million tonnes.

Massive quartzite from the Hunt property at Nicholson is mined and shipped to Washington State for the production of silicon and ferrosilicon. The purity of the quartzite is similar to that of Moberly with a SiO₂ content in excess of 99.85 per cent. Reserves in 1985 were calculated to be 3 million tonnes (Foye, 1987).

CONCLUSIONS

In southeastern British Columbia, there are 6 companies producing 4 industrial minerals. These include magnesite, gypsum, barite and silica. Exploration is currently in progress for phosphate, barite, gypsum and magnesite. There is also potential for wollastonite and garnet.

The potential for the discovery of additional industrial mineral deposits in southeastern British Columbia is good. As markets develop one may expect an increase in current production as well as the development of new sources of industrial minerals.

REFERENCES

- Butrenchuk, S.B. (1987): Phosphate Inventory (82G and J); *B.C. Ministry of Energy, Mines and Petroleum Resources*, Geological Fieldwork, 1986, Paper 1987-1, pages 289-302.
- Butrenchuk, S.B. (1987): Phosphate in Southeastern British Columbia; *Ministry of Energy, Mines and Petroleum Resources*, Open File, 1987-16, 103 pages.
- Butrenchuk, S.B. (1989): Gypsum in British Columbia; *B.C. Energy, Mines and Petroleum Resources*, Geological Fieldwork 1988, Paper 1989-1, pages 497-506.
- Butrenchuk, S.B. (1988): Petrology and Geochemistry of in British Columbia; Paper presented at the Annual General Meeting - *Canadian Institute of Mining and Metallurgy*, Edmonton, Alberta, May 8-12, 1985.
- Foye, G. (1987): Silica Occurrences in British Columbia; *B.C. Ministry of Energy, Mines and Petroleum Resources*, Open File 1987-15, 55 pages.
- Höy, T. (1980): Stratigraphic and Structural Setting of Stratabound Lead-Zinc Deposits in Southeastern B.C.; Paper presented at *CIM District 6 Meeting*, Kimberley, B.C., October 4, 1980.
- Legun, A. and Buttner, C. (1991): Kootenay District, B.C. Ministry of Energy, Mines and Petroleum Resources; *B.C.M.E.M.P.R.*, British Columbia Mineral Exploration Review 1990, Information Circular 1991-1, pages 65-71.
- Shanks, T. (1977): A Geological Study of Moberly Mountain Silica Property; *Mountain Minerals Co. Ltd.*, internal company report.

GEOLOGICAL HISTORY OF THE WESTERN CANADA SEDIMENTARY BASIN

By Grant D. Mossop

*Alberta Geological Survey, Alberta Research Council,
Edmonton, Alberta.*

ABSTRACT

The Western Canada Sedimentary Basin comprises a wedge of dominantly Phanerozoic strata above Precambrian crystalline basement. The wedge tapers from a maximum thickness of about 6000 metres in the axis of the Alberta Syncline (just east of the Foothills front) to a zero edge in the northeast along the Canadian Shield. The succession reflects sedimentation in two profoundly different tectonic settings - Late Proterozoic to Jurassic platformal succession dominated by carbonate rocks, deposited on the stable craton adjacent to the passive margin of ancient North America; overlain by a clastics-dominated foreland basin wedge deposited in mid-Jurassic to Paleocene times during active margin orogenic evolution of the Canadian Cordillera.

The platformal succession consists of four major sequences, each representing more or less continuous internal deposition but separated from adjacent sequences by profound regional unconformities. Patterns of marine inundation, sedimentation and erosion were influenced by epeirogenic movement on various intracratonic arches, that episodically differentiated the region into a complex of sub-basins and uplifts.

Beginning in the mid-Jurassic, as North America began to drift westward with the opening of the Atlantic, the western margin of the continent was subjected to at least two major episodes of compressive tectonism, as a result of collision with large oceanic terranes that accreted onto the continent in the west. Strata originally deposited outboard of the ancient passive margin of the continent were compressed and displaced eastward over the continental margin. In turn, platformal cover rocks were thrust and folded to form the Canadian Rocky Mountains and Foothills. Emplacement of the imbricate thrust slices, progressively from west to east, produced tectonic thickening of the crust and isostatic downward of the foreland, forming an eastward-migrating trough that trapped clastic detritus shed from the developing mountains. Net erosion and sediment bypass have prevailed in the region since the Paleocene culmination of the Laramide Orogeny.

AN OVERVIEW OF THE SASKATCHEWAN POTASH INDUSTRY

By Keith S. Crosby

*International Minerals & Chemical Corporation
(Canada) Ltd., Esterhazy, Saskatchewan*

ABSTRACT

Nearly 30 years have past since International Minerals & Chemical Corporation (Canada) Limited produced the first Canadian potash near Esterhazy, Saskatchewan. Today potash is a billion dollar industry in Saskatchewan where the annual design capacity of 10 mines is 10.6 million tonnes K₂O equivalent. In 1989, planned production of 6.5 million tonnes of product accounted for approximately 21 per cent of world production.

In Saskatchewan, sylvite (KCl) is mined from two members within the Middle Devonian Prairie Formation, with production concentrated near Saskatoon and Esterhazy - Rocanville. Compared to most salt deposits, the Prairie Evaporites have witnessed only limited kinematic disturbance. Locally, due to metasomatism, each mine experiences mineralogical and consequential grade changes. Anomalous stratigraphic and structural disturbances are coincident with underlying reefal mounds and syn- to post-depositional leaching and erosional phenomena.

At present production rates, potash resources in Saskatchewan represent nearly 600 years of reserves. Producers are, however, bound by a volatile world market. Five year forecasts suggest the potash industry will continue to be plagued by long and short-term implications on consumption and production. The Saskatchewan potash industry infrastructure is well established. Its ability to maintain or increase its share in the marketplace will depend on improved mining and milling technology, maintaining an efficient transportation system and exporting strategies.

World demand for potash is expected to grow in the 1990s. Saskatchewan producers are positioned to, not only remain as competitive and reliable suppliers, but to increase production once world supply and demand become better balanced.

INTRODUCTION

As a leading commodity in the industrial minerals sector, the discovery, development and future outlook of the Saskatchewan potash industry deserves special interest within the Canadian mining industry. This billion dollar industry accounts for nearly one-third of Saskatchewan's mineral production, directly accounting for over 3 000 jobs. Although the Canadian potash industry witnessed only 64 per cent utilization of production capacity in 1989/90, growth in world demand is expected to increase production capacity utilization to nearly 81 per cent by 1995. In fact, whether the potash market is for fertilizer or chemical and associated industries, some market analysts forecast potash demand will be greater than supply before the turn of the century. This translates to Canadian producers supplying 25 per cent of the world's market today, which is expected to increase to over 28 per cent by 1995.

If vertical or lateral stratigraphic, structural and mineralogical changes in Canadian potash mines was not challenging enough, complex global marketing conditions are also having a significant impact on potash producers' sales and profit margins. Political changes and consequential moves to a free market economy in eastern Europe, climatic changes and mine closures have lead to significant fluctuations in potash production or consumption in countries as the Soviet Union, China, the eastern European community and the United States. Consequently, the market values of potash has fluctuated accordingly.

At the global level, potash consuming crops such as corn and soybean are expected to grow in direct ratio with the growth in world population, particularly in underdeveloped countries. This will lead to a better balance in the world potash supply and demand by the late 1990s. Saskatchewan's core of modern, high tech and low-cost producers are positioned to remain as competitive and reliable potash suppliers in an ever-increasing competitive world market.

HISTORICAL BACKGROUND OF THE SASKATCHEWAN POTASH MINING INDUSTRY

Potash - indeed its very name describes the historical and yet natural evolution of this product. "Pot ash" an alkaline substance or crude potassium carbonate leached in iron pots from wood ashes for centuries served in cleansing, medicinal and food seasoning applications. Later its use in the early glass, soap and cloth industries evolved.

In the mid-1800s, a German chemist, Justus von Liebig, chemically detected phosphate and potassium in ashes of burned plants and ammonia in the vapours. The age of agricultural chemistry began.

Today, "potash" is a term applied to the common salts of potassium. Soluble potassium salts occur in crystalline form within evaporite deposits and were first discovered in rock salt deposits in Germany in 1839. Germany supplied the world with potash from 1861 until the first world war. Shortages of potash resulted in exploration and discovery of potash in New Mexico in 1927. Today potash is produced commercially in the Soviet Union, Germany, the United States, Israel, France, Jordan, Spain, United Kingdom, Italy, Brazil, China, Chile, and of course Canada.

During the search for oil in Saskatchewan in 1942, the most common potassium-bearing salt minerals, sylvite and carnallite were first recognized in salt cores taken from a depth of 2 330 metres (7 644 ft). The world's largest deposit of potash was incidentally discovered. Potash was discovered in a second well in 1943. However, due to the discovery location and consequential depth and low grade of these first discoveries of potash, little

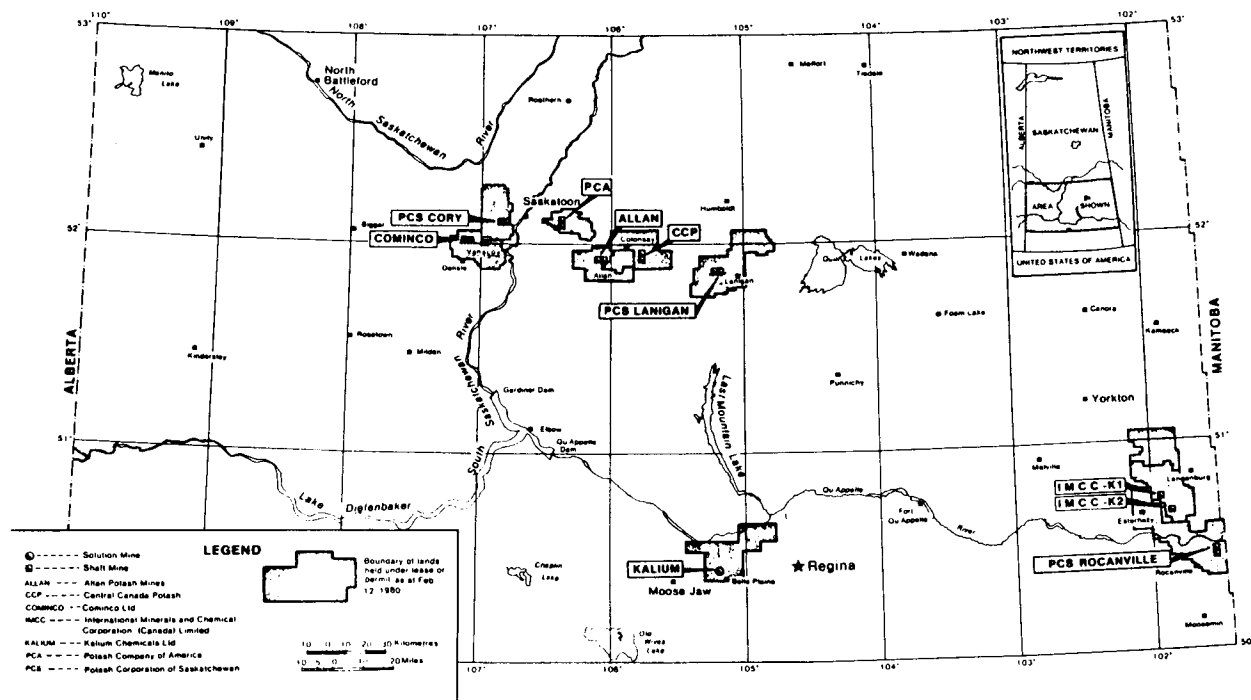

Figure 1. Potash mines, lease and permit areas in Saskatchewan (after Fuzesy, 1982).

interest was made of the potassium-bearing salt deposit. After the war in 1946, during testing for natural gas, a well penetrated 140 metres (459 ft) of salt with core containing 35.4 per cent sylvite (KCl) over a 3.3 metres (11 ft) interval (Fuzesy, 1982). This was possibly the first indication of commercial grade potash beds and at a depth of 1056 metres (3 464 ft), shaft mining was considered feasible. However, uncertainties to markets, depths and grades of deposits all helped to postpone exploration for commercial potash for 10 years.

The eventual geological summation that potash ore in beds 2.4 to 3 metres (8 to 10 ft) at the 900 to 1300 metre (3 000 to 4 000 ft) depth was mineable led to the first shaft sinking in Saskatchewan. In 1958, the first shaft was completed by the Potash Company of America near Saskatoon through perhaps the world's most challenging high pressure water and sedimentary rock. However, production was suspended in 1959 due to water seepage in the shaft and the mine remained unproductive until 1965.

In 1962, after a five year struggle, IMC Canada was successful in sinking a shaft to 1029 metres (3 378 ft) near Esterhazy in southeastern Saskatchewan. Continuous production at the IMC Canada K-1 mine followed and later paved the way for a second IMC Canada mine (K-2) which was completed in 1967. Eight other potash mines also went into production during an eight year period (Figure 1). Today the 10 Saskatchewan potash mines account for approximately 21 per cent of world production and about 87 per cent of Canadian potash.

A typical conventional potash mining operation, IMC Canada, produces five different potash products classified according to particle size. In order from the largest to the smallest are granular, coarse, standard, special standard and white muriate.

GEOLOGICAL SETTING

The potassium-bearing minerals of which the Saskatchewan potash industry is based occurs within evaporite strata in the upper 70 metres (231 ft) of the middle Devonian Prairie Formation. The Prairie Formation evaporites were deposited within the Devonian Elk Point Basin which extended from southeastern Northwest Territories and comprises most of southern Saskatchewan, southwestern Manitoba, northwestern North Dakota and northeastern Montana (Figure 2).

The Prairie Formation is the youngest formation of the Elk Point Group, which also includes the Winnipegosis and Ashern Formations. The Prairie Formation is unconformably overlain by the middle Devonian Manitoba Group, consisting in ascending order the Dawson Bay and Souris River Formations (Figure 3). Prairie Evaporite strata is locally 200 metres (656 ft) thick, but can be less than 40 metres (131 ft) in total thickness as depicted by recent seismic reflection surveys in the Esterhazy area.

Depositional variations are usually gradual, although abrupt and pronounced changes in grade and thickness of potash-bearing strata occur due to partial solutioning, penecontemporaneous paleochannel erosion, pre-Dawson Bay erosion, or due to Winnipegosis carbonate mound buildups and often related solution and collapse structures.

Prairie Formation strata normally strike at N 60° W, with a south to southwesterly dip of about 6 metres per kilometre. In Saskatchewan, the top of the Prairie Evaporite strata are found at depths between 885 metres in the northeast and 1 500 metres toward the southwest in the Regina - Moose Jaw area. In the Montana - North Dakota region, the Prairie Formation lies at depths ranging from 1 700 to more than 3 600 metres. See Figure 4

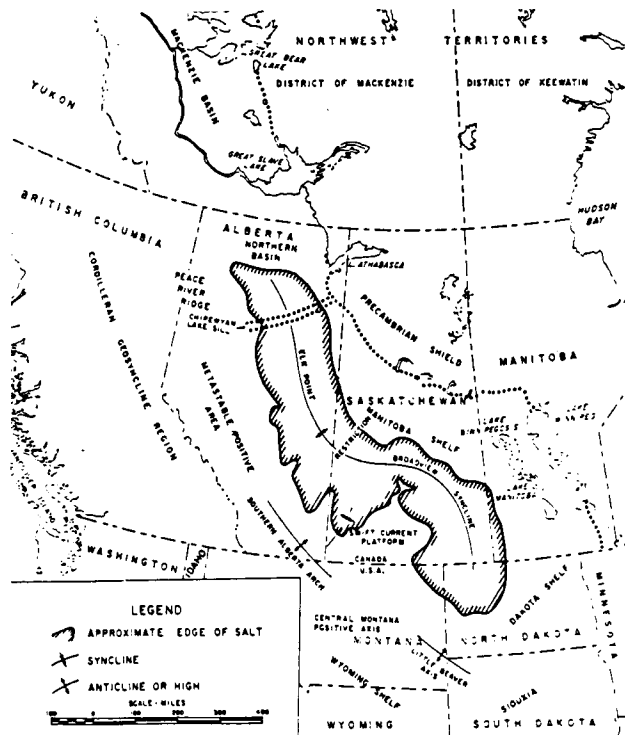

Figure 2. The Elk Point salt basin and related tectonic elements.

for structural contour map showing depth to the top of the potash ore bed within the Esterhazy member in the Esterhazy region.

The four potash-bearing members of the Prairie Formation are in ascending order and average thickness, the Esterhazy (17 metres) (56 ft), White Bear (4 metres) (13 ft), Belle Plaine (14 metres) (46 ft) and Patience Lake (18 metres) (59 ft) (Figure 5). All members contain one or more beds of sylvinite interbedded with near-barren halite. Individual potash beds are locally 7 metres (23 ft) thick. Apart from the White Bear member, successively higher members extend farther toward the northeast of Saskatchewan.

Potash mining is conducted in the lowermost Esterhazy member at the three mines in the Esterhazy - Rocanville area. In the Saskatoon - Lanigan region, conventional and more recently solution mining is conducted within the younger Patience Lake member. Near Regina, solution mining is conducted within the Belle Plaine member.

A typical conventional mining operation is found near Esterhazy, southeastern Saskatchewan. There the largest privately-owned potash mining operation in the world mines a 2.4 metres (8 ft) thick, high grade sylvinitic bed. The normally carnallitic sylvinitic bed may average 40 per cent KCl (25% K₂O), at a depth of 970 metres (3 182 ft).

MINERALOGY

Potash beds in all four members of the Prairie Formation have a fairly simple mineralogy, consisting predominantly of halite (NaCl), and two potassium chloride minerals, sylvite (KCl) and the undesirable mineral, carnallite (KCl·MgCl₂·6H₂O). Insoluble materials include

minor amounts (usually less than 2 to 3%) of clay minerals, as illite and chlorite. Of equal concentration, insolubles also consist of anhydrite, dolomite and quartz. The undesirable insoluble materials occur as interstices between crystals, irregular patches, thin seams and partings, to significant bands or beds. The concentration of insoluble minerals is quite variable vertically, but remain fairly uniform laterally other than for abrupt anomalous paleo-erosional channels and leaching structures which are characterized by high quantities of clays. The Esterhazy and Rocanville potash mines use distinct beds with higher or lower insoluble content as guides for correlation in the mining operation.

Halite crystals normally range from about 5 to 25 millimetres, however, can be up to 20 centimetres in diameter. Halite crystals are normally transparent to translucent, mainly colorless or milky white. Pink, reddish, deep blue, violet and yellow crystals are not uncommon.

Sylvite crystals are highly heterogeneous in color, ranging from colorless, milky white, light orange, brown to blood red. Sylvite mineralization is very similar in appearance to halite, both are isotropic, with perfect cubic cleavage and an interlocking mosaic texture. Sylvite crystals normally range from 0.5 millimetres to 20 millimetres although it is not uncommon to find vertical and lateral lenses with crystals up to 10 centimetres in diameter. Perhaps the most distinctive characteristic of sylvite is it is less dense and less brittle than halite and has a characteristic bitter taste.

Unlike halite and sylvite, carnallite loses water at relatively low temperature and is deliquescent, thus its ability to dissolve away by attracting and absorbing water from the atmosphere. Carnallite generally ranges from light brown to blood red but may be colorless, milky white, yellow purple to black. Carnallite is soft and brittle and has a distinctive greasy lustre and very bitter taste. When associated with halite and sylvite, carnallite occurs along small cracks or crevices, often with interlocking crystals or irregular patches. If present, crystals can vary from less than 1 millimetre to 3 centimetres in width. Perhaps the most spectacular display of carnallite occurs as pure, colorless, yellow, tabular carnallite crystals in pods or lenses up to 5 metres (16 ft) across.

All four potash members of the Prairie Formation are characterized by local zones of high carnallitic sylvinitic. Potash mines in the Saskatoon and Lanigan region which mine the Patience Lake member are in essence relatively carnallite free. However, in the Esterhazy and Rocanville region, gradational to abrupt horizontal and vertical increases in carnallite content is a significant problem in reducing average ore grade level, as well as causing unstable ground conditions. Carnallite-filled fractures and pods which are most often associated with high carnallite mineralization subject Saskatchewan potash mines to abnormally high closure rates, slabbing and microseismic activity which necessitates continuous geological mapping, geophysical surveys and rock mechanics surveillance.

POTASH UTILIZATION

About 96 per cent of the world production of potash is used in fertilizers (Figure 6). The balance is used in chemical and associated industries.

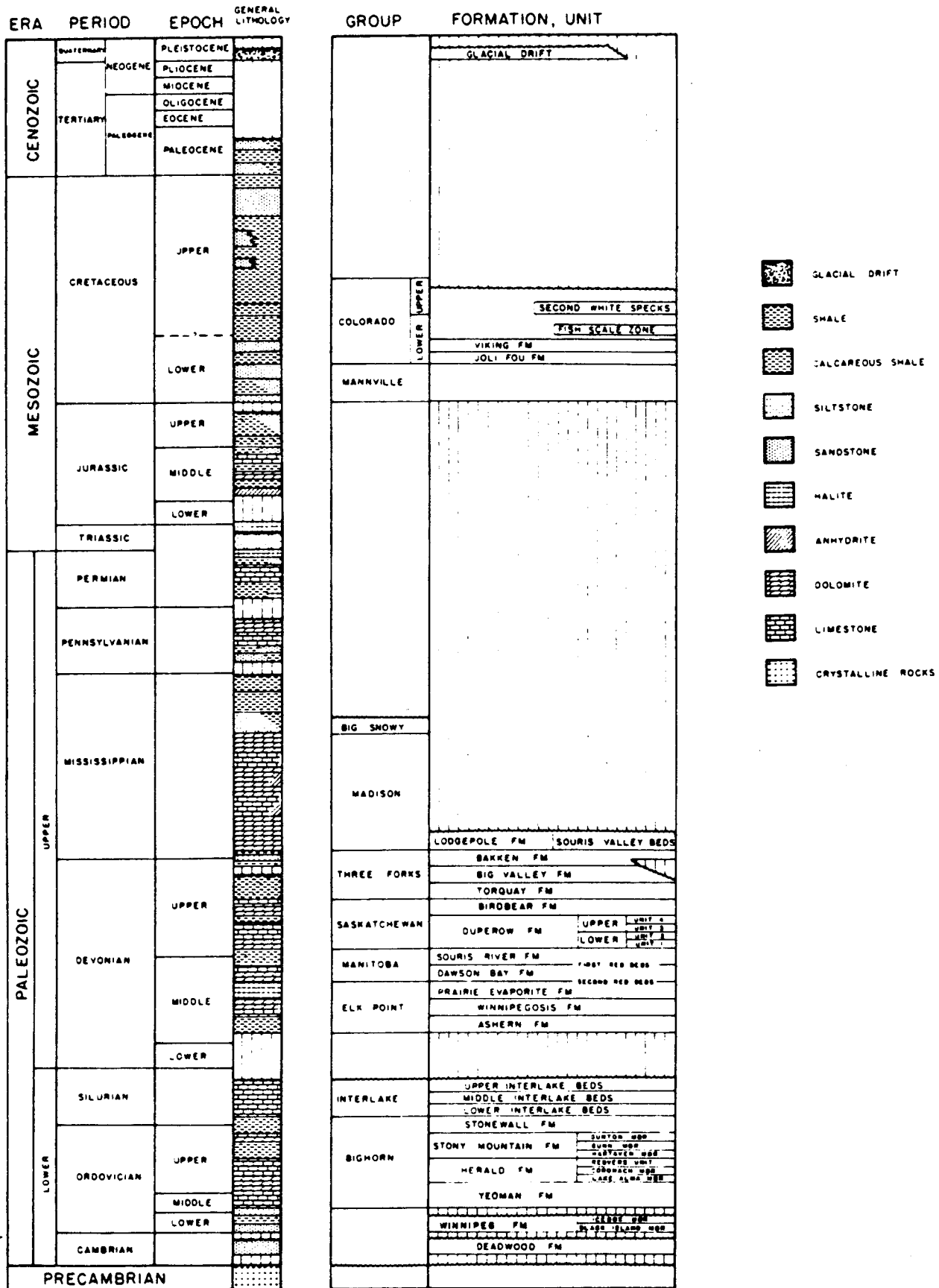

Figure 3. Stratigraphic table (after Holter, 1969).

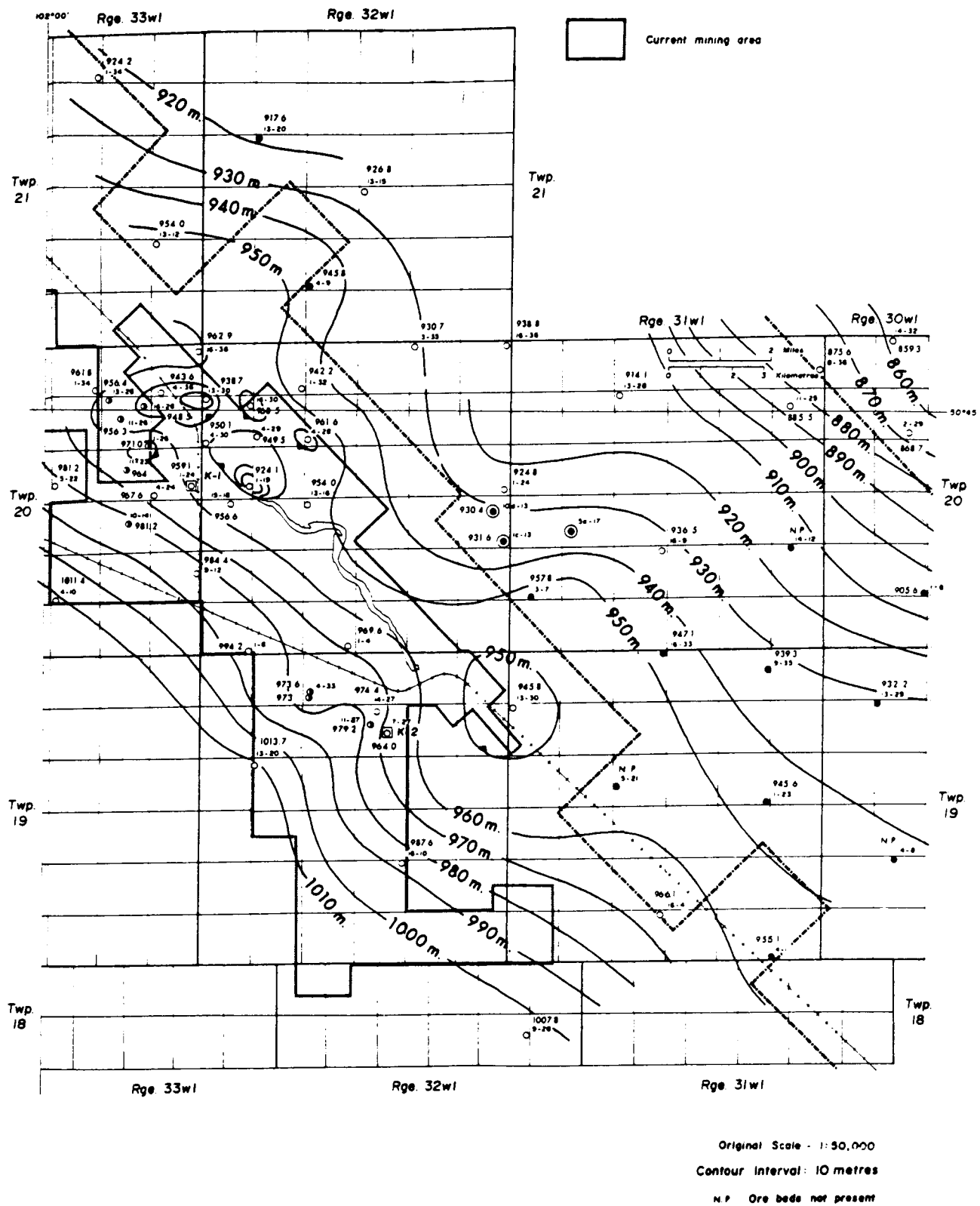

Figure 4. Depth to the top of the Potash ore beds.

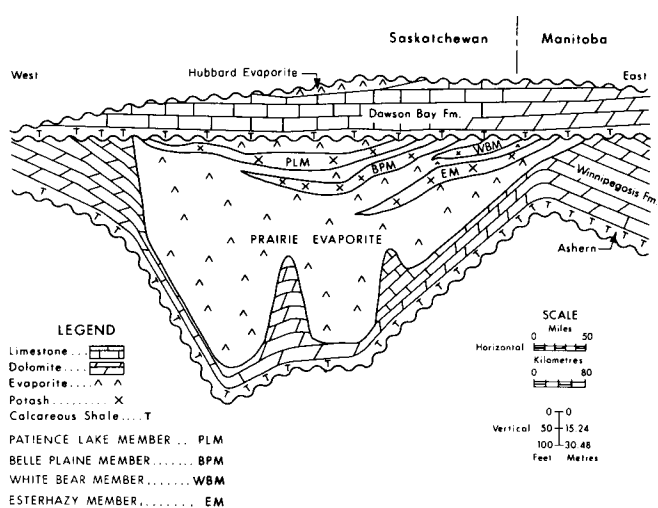

Figure 5. Diagrammatic cross section through the Prairie Evaporite in Saskatchewan and Manitoba (after Fuzesy, 1982).

Potassium chloride (KCl) or muriate of potash is the most common in the fertilizer industry. In the agriculture industry, over 90 per cent is muriate of potash, the remainder is sulphate of potash (K_2SO_4), sulphate of potash-magnesia ($K_2SO_4 \cdot MgSO_4$) and nitrate of potash (KNO_3). Potash is normally applied in compound fertilizers, mixed as per crop type, climate and soil condition. The starch and sugar crops, cereals and potatoes, are examples of crops which require large amounts of potassium. Sulphate of potassium salt is most often used in areas of low rainfall where the chloride ion tends to build

up in the soil. Tobacco, fruit crops and sugar beets are crops which may prefer a potassium sulphate fertilizer.

Most of the chemical grade potassium chloride is used for potassium hydroxide (caustic potash) production. The major potassium chemical consuming industries include detergents and soaps, glass and ceramics, textiles and dyes, chemicals and drugs. It can be used in the manufacture of synthetic rubber, photographic film, insecticides, television tubes, pharmaceuticals, petroleum catalysts, special quality glass for chinaware and fluorescent lamps. Numerous potassium compounds produced from potash have a wide range of uses - potassium chlorate for match heads, fireworks, explosives; potassium chloride for drilling mud, and as a salt substitute in low-salt diets; potassium cyanide for fumigant and insecticides, as a re-agent for preparation of metals as gold, silver and copper; potassium ferro-cyanide as the active agent in blueprint paper, as an antiseptic and in saccharine; potassium nitrate or niter is used as a curing agent for meats; and the list goes on!

POTASH RESOURCES IN CANADA

Potash is a billion dollar industry in Canada where it is mined in two provinces, Saskatchewan and New Brunswick. The potash industry contributes \$350 million in Canada towards transportation and handling systems, and over \$100 million in royalties, provincial levies and federal taxes (Barry, 1990).

In New Brunswick, three economically proven potash deposits are known to exist, two of which are in production. New Brunswick deposits represent over a billion tonnes of geological reserves. The Rio Algom (PCA) ore body is steeply-dipping or domal in shape and requires mechanized cut and fill mining, with a maximum

FEBRUARY 1991

	PRODUCTION		ENDING INVENTORY February 28				DISAPPEARANCE	
	1991	1990	MINE SITE	OFFSITE	1991	1990	1991	1990
MURIATE								
Special Standard	3,063	7,368	10,863	23,722	34,585	38,683	5,610	5,367
Standard	241,308	132,933	196,659	121,897	318,556	541,620	236,591	201,191
Chemical	1,527	10,410	5,876	2,200	8,076	11,954	6,887	13,989
Coarse	195,842	181,415	213,393	350,497	563,890	551,022	83,507	77,116
Granular	260,869	204,044	304,832	210,332	515,164	508,826	157,761	159,835
Soluble	<u>73,580</u>	<u>52,935</u>	<u>87,989</u>	<u>59,518</u>	<u>147,507</u>	<u>155,530</u>	<u>49,183</u>	<u>46,827</u>
TOTAL:	776,189	589,105	819,612	768,166	1,587,778	1,807,635	539,539	504,325

	AGRICULTURAL SALES				NON-AGRICULTURAL SALES				TOTAL AG & NON-AG SALES	
	U.S. & CANADA		EXPORTS		U.S. & CANADA		EXPORTS		FEBRUARY	
	1991	1990	1991	1990	1991	1990	1991	1990	1991	1990
MURIATE										
Special Std	15	12	5,557	5,793	-	-	-	-	5,572	5,805
Standard	16,311	18,157	225,059	171,206	10,986	8,025	-	-	252,356	197,388
Chemical	-	-	-	-	2,831	6,773	124	275	2,955	7,048
Coarse	85,469	88,358	24,674	7,250	-	-	-	-	110,143	95,608
Granular	79,528	120,989	26,153	25,771	-	-	-	-	105,681	146,760
Soluble	<u>20,087</u>	<u>19,425</u>	<u>6,552</u>	<u>6,390</u>	<u>7,223</u>	<u>10,888</u>	<u>11,574</u>	<u>15,843</u>	<u>45,436</u>	<u>52,546</u>
TOTAL:	201,410	246,941	287,995	216,410	21,040	25,686	11,698	16,118	522,143	505,155

Figure 6. Potash & Phosphate Institute report of potash production, inventory, disappearance and sales by Canadian producers (from "Potash and Phosphate Institute" April, 1991 Potash Report).

capacity of approximately 670 000 metric tonnes KCl. The Potacan Mining Co. anticlinal-shaped ore body requires both drill and blast methods, with a maximum capacity of 1.3 metric tonnes KCl. A third potash deposit owned by BP Resources (Canada) Ltd. awaits development.

The Saskatchewan potash industry represents by far the largest reserves in Canada where over 6 billion tonnes of economical potash reserves are believed to exist. Saskatchewan produces one-quarter of the world's potash supply and retains over 40 per cent of the world's potash reserves. At current production rates, this translates to over 600 years of economic reserves.

There are currently eight shaft or conventional mines operating in Saskatchewan and two solution mines. These mines employ about 3000 and account for about 5 per cent of the provincial GDP and nearly one-third of the value of provincial mineral production.

Current potash operators in Saskatchewan include International Minerals & Chemical Corporation (Canada) Ltd., the largest independent producer in the world. IMC Canada's two mines, K-1 and K-2, have a combined production capacity of 3.81 million tonnes KCl (2.3 million tonnes K₂O). Other producers include Central Canada Potash (Noranda) at Colonsay, Cominco Ltd. at Vanscoy, and Potash Corporation of Saskatchewan (PCS) Mining Ltd. which operates four mines including the Lanigan division at Guernsey, the Allan division at Allan, the Cory division near Saskatoon and the Rocanville division at Rocanville. Once a 100 per cent government-owned company, PCS has been largely privatized. By 1991, the Saskatchewan government retained 28 per cent of the corporation's public shares and is holding another 29 per cent in trust for PCS bondholders.

Two solution mines now operate in Saskatchewan including Kalium Canada Ltd. located at Belle Plaine near Regina, and PCA, a division of Rio Algom Ltd., which lost its shaft mine near Saskatoon to flooding in 1987.

Potential for new mine development in Canada is supply and demand dependent. In the future, construction of new mines could take place not only in Saskatchewan, but as well in New Brunswick and Manitoba.

A GLOBAL MARKETING OVERVIEW

In 1989, Canadian potash production was 7.36 million tonnes K₂O with sales of 7.13 million tonnes (Barry, 1989). This placed Canada second in potash production with 25 per cent of world production. Only 4.4 per cent of production, however, was used domestically, less than 7 per cent of U.S. consumption. The remaining potash was exported to 37 countries. One can therefore see that the Canadian potash industry is greatly dependent on international trade.

The volume of potash produced internationally is also becoming more dependent on volatile global conditions. Events that happen around the world have an increasingly significant impact on potash production and sales. During the 1980s, world potash production ranged from 24 million tonnes to a record 32 million tonnes in 1988. In 1989, 13 countries produced over 30 million tonnes of potash. However, over 70 per cent of this world production is accounted for by three countries, the Soviet Union, Canada and what until recently was known as

Year	Volume Produced ('000 tonnes K ₂ O)	Volume Sold ('000 tonnes K ₂ O)	Value of Sales ('000 \$)	Average Price (\$ / tonne)
1962	136	73	3,000	41.10
1963	569	569	22,500	39.54
1964	779	778	31,162	40.05
1965	1 470	1 353	55,971	41.37
1966	1 820	1 805	62,665	34.72
1967	2 340	2 162	67,395	31.17
1968	2 800	2 647	65,121	24.60
1969	3 400	3 168	69,383	21.90
1970	3 173	3 052	108,695	35.61
1971	3 572	3 606	145,966	40.48
1972	3 927	3 703	146,014	39.43
1973	4 249	4 787	196,025	40.74
1974	5 496	5 730	311,621	54.38
1975	5 433	4 677	348,494	74.51
1976	4 991	5 168	358,399	69.35
1977	6 090	5 699	398,055	69.85
1978	6 113	6 453	496,718	76.82
1979	6 707	7 146	733,346	102.62
1980	7 302	7 127	1,009,754	141.68
1981	7 189	6 357	995,136	156.54
1982	5 212	5 087	642,867	126.37
1983	5 928	6 599	685,902	103.94
1984	7 650	6 998	829,446	118.52
1985	6 412	6 377	621,515	97.46
1986	6 031	6 308	549,791	87.15
1987	6 449	7 022	670,739	95.52
1988	7 372	7 106	974,974	137.20
1989	6 509	6 275	879,601	140.17

Figure 7. Historical summary of potash production, disposition and sales value (from "Potash and Phosphate Institute").

East Germany. It is therefore clear that the economic and social restructuring of potash-producing countries as the Soviet Union and Germany are of particular importance to a Saskatchewan potash producer.

Whether it be political turmoil of an importing or exporting nation, unexpected increased exports from abroad, climatic changes, mine expansion or closures, basic money supply of importing nations, or the state of a producing nations' storage, production and distribution infrastructure, the dependence of Canada's potash producers on global conditions is very evident.

Canadian potash production fell by 12 per cent in 1989 or about 1.3 million tonnes. This production decline paralleled a decline in exports to the large markets of China and Brazil (Elliot, 1990). As well, in the U.S. where 60 per cent of Saskatchewan's potash is designated, the increase in planned potash fertilizer consumption for 1989/90 was lower than expected. Planted acreage increased by 3.7 per cent, however, farmers reduced rates of application due to carry over nutrients in the soil following the 1988 drought (Barry, 1990). Several smaller and fast-growing potash importers also had a decline in demand in excess of 5 per cent.

This brief international overview only touched upon a few of the many global factors which constantly produce a challenging marketing environment. Yet with its infrastructure well established, Saskatchewan's future ability to maintain or increase its share in international fertilizer trade will largely depend on improved mining and milling technology, maintaining an efficient transportation system and exporting strategies.

FUTURE OUTLOOK

The late 1970s were characterized by a strong global growth in the demand for potash (Figure 7). This repre-

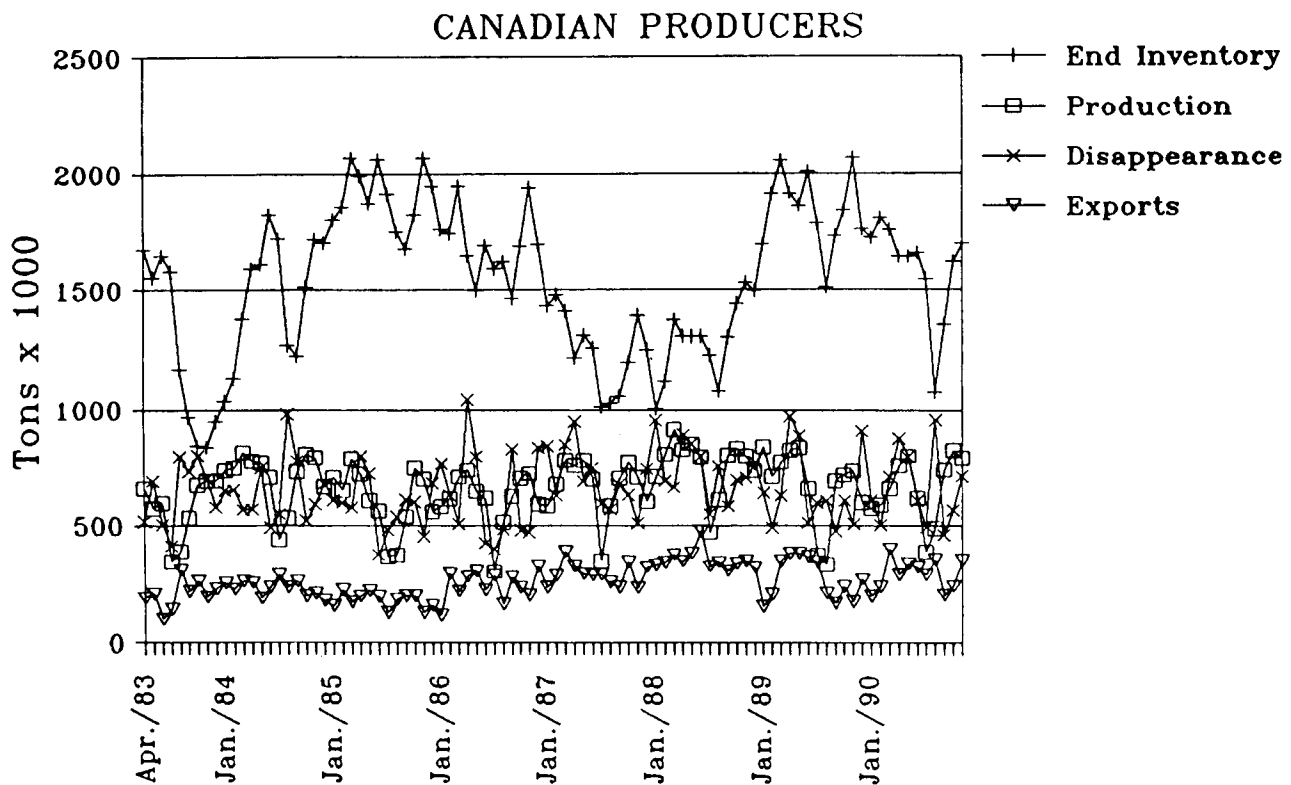

Figure 8. Potash summary - April 1983 to November 1990 (from "Potash and Phosphate Institute" Potash Report).

sented several years of good prices. Optimism flourished in the potash industry and several companies in Saskatchewan, led by PCS, proceeded with significant mine expansions. As well, the early 1980s witnessed two new mines coming on stream in New Brunswick. Offshore, new capacity was installed in the Soviet Union, Jordan and attempted in Brazil. However, by the mid 1980s the strong growth in demand waned and a state of over capacity evolved which continues to exist today (Figure 8).

Total Canadian potash capacity by 1990 reached 19.2 million tonnes KCl or 11.5 million tonnes K₂O - over 30 per cent of the world's total (Barry, 1990). In mid-1990, there was about 4 million tonnes of excess potash production capacity in the world, most of this was in Canada. This should not be confused with overproduction or oversupply. Overall world potash capacity utilization is approximately 82 per cent. However, Canadian producers average capacity utilization is 64 per cent (Figure 9). It is clear that Canadian producers are more than adequately fulfilling the role of swing supplier. Canadian producers have and continue to close mines intermittently for weeks duration for inventory control.

Western producers have in fact been confronted with increased Soviet potash exports. This is seen by traditional traders as market disruptive. As a consequence of reduced domestic potash consumption in the USSR, growth of Soviet potash exports will continue to increase before levelling off by the mid-1990s. The higher Soviet exports are offset to some degree by lower production and exports by today's new Germany. Increased potash prices in North America should allow marginal

U.S. mines to operate for a few more years. In Canada, the continued unsettled global conditions will probably require continued intermittent mine closures to balance supply and demand (Barry, 1990).

On a more positive note, world demand for potash is expected to grow at an annual rate of 1.7 to 2.0 per cent for the next 15 years. Modest production increases may continue outside Canada due to existing expansion commitments. Approximately 1.0 to 2.0 million tonnes of capacity is expected to be added before the year 2000.

Growth in world demand is expected to outpace the expected supply increase resulting through mine expansion. Overall implications for potash consumption for a long-term grain consumption forecast is positive. World grain consumption continues to grow at an annual rate of 2 per cent while the world population grows by 1.7 per cent per year. This is equivalent to the population of the United States and Canada every three years. About 90

	Actual			Forecast		
	1986	1987 (thousand tonnes K ₂ O)	1988	1989	1990	1995
Capacity	10,580	11,020	11,430	11,550	11,800	11,800
Production	6,698	7,267	8,328	7,360	7,300	9,500
Capacity Utilization (%)	63	66	73	64	62	81
Sales	7,023	7,837	8,030	7,100	7,500	9,500
of which						
Domestic	322	480	420	360	400	n.a.
United States	4,091	4,224	3,830	3,820	3,900	n.a.
Offshore	2,610	3,114	3,780	2,920	3,100	n.a.
End-year stocks	1,537	1,135	1,360	1,600	1,400	1,500
World Production	28,551	29,309	31,650	30,300	30,600	33,600
Canada/World Production Ratio (%)	23.5	24.7	26.3	24.3	24.2	28.3

Source: EMR, MPS Canada

Figure 9. Canada potash, current situation and forecast (from Fertilizer Focus, May 1990).

per cent of this increase in population will be in underdeveloped countries. Higher population combined with growing world income and near constant per capital grain consumption bodes well for the two largest potash-consuming crops, corn and soybean.

It is predicted that world potash supply and demand will become balanced by the late 1990s. Saskatchewan mines could be the first to increase their production capacity. This could be achieved by small expansions of existing mines. However, new mine construction cannot be ruled out, whether it be in New Brunswick or Manitoba.

Potash is a very significant part of the Saskatchewan as well as the Canadian mining industry. We should consider ourselves fortunate of having the largest and highest grade potash reserves in the world. It should be of particular pride and credit to the Saskatchewan potash producers that operating costs of Canadian mines are the most efficient in the world. In fact, operating costs in Canada are only half as high as those mines in the U.S. and Europe and many times lower than in the USSR.

One is therefore able to state that Saskatchewan producers are well positioned to remain not only as competitive and reliable suppliers in a volatile global industry, but to increase production once world supply and demand for potash become better balanced.

ACKNOWLEDGMENTS

I am grateful for permission from International Minerals & Chemical Corporation (Canada) Limited to use data from the corporation and allowing me to present this paper at the 27th Forum on the Geology of Industrial Minerals.

REFERENCES

- Barry, G.S. (1989): Potash; Chapter in Canadian Minerals Yearbook, Mineral Policy Sector, *Energy Mines and Resources Canada*.
- Barry, G.S. (1990): Opinion, Potash in Canada; *Fertilizer Focus*, Mineral Policy Sector, Energy Mines and Resources Canada.
- Elliot, A. (1990): The Potash Situation in Canada; Presented in Washington D.C. for the Economics and Information Committee of the Fertilizer Institute.
- Fuzesy, A. (1982): Potash in Saskatchewan; *Saskatchewan Geological Survey*, Report 181.
- Holter, M.E. (1969): The Middle Devonian Prairie Evaporite of Saskatchewan; *Saskatchewan Department of Mineral Resources*, Report 123.

REGIONAL GEOLOGY OF THE MOUNT BRUSSILOF CARBONATE-HOSTED MAGNESITE DEPOSIT, SOUTHEASTERN BRITISH COLUMBIA, CANADA.

By George J. Simandl, Kirk D. Hancock, Dan Z. Hora, Mary E. MacLean
Suzanne Paradis

B.C. Ministry of Energy, Mines and Petroleum
Resources, Victoria, B.C.

Geological Survey of Canada, Quebec Geoscience Centre

ABSTRACT

The high-grade, medium-tonnage Mount Brussilof magnesite orebody and related deposits are located adjacent to and east of a Cambrian positive bathymetric feature commonly referred to as the Cathedral Escarpment. Host rocks are fine-grained dolomites and limestones of the Middle Cambrian Cathedral Formation containing well-preserved sedimentary and diagenetic textures. Near the Escarpment carbonates are locally brecciated and cemented by sparry dolomite and portions of the Cathedral Formation are altered entirely to sparry dolomite and magnesite. The Mount Brussilof deposit consists of sparry magnesite with local concentrations of pyrite and amorphous iron oxides. Dolomite, palygorskite, calcite, talc, quartz, phlogopite, huntite, brucite, fersmite, malachite, tetrahedrite, pentlandite and boulangerite are also present. The conversion of fine-grained dolomite to sparry carbonate results in replacement features such as remnants of fine-grained dolomite and *yoholaminites*, and bipolar growth of sparry carbonates perpendicular to fractures. The shape of the deposits, the nature of ore-host contacts, textures and chemistry suggest that the Mount Brussilof deposit formed by the interaction of Mg^{2+} rich fluids with a carbonate protolith. Further work is under way to confirm this hypothesis.

The carbonate rocks along and east of the Cathedral Escarpment have excellent potential to host other magnesite deposits.

INTRODUCTION

A number of magnesite deposits have been docu-



Plate 1. Mount Brussilof mine.

mented in British Columbia (Grant, 1987). The most important of these is the Mount Brussilof orebody (Plate 1). It is located in southeastern British Columbia (Figure 1), approximately 35 kilometres northeast of Radium Hot Springs. The deposit is accessible from Highway 93 by an all-weather unpaved road.

HISTORY AND PRODUCTION

The Mount Brussilof deposit was discovered during regional mapping by the Geological Survey of Canada (Leech, 1965). Baykal Minerals Ltd. and Brussilof Resources Ltd. staked and explored the deposit and in 1971, they merged to form Baymag Mines Co. In 1979, Refratechnik GmbH. acquired Baymag Mines Co. (MacLean, 1988). In 1980, proven and probable geological reserves were 9.5 million tonnes grading over 95 per cent magnesia in calcined product and an additional 13.6 million tonnes of 93 to 95 per cent magnesia in calcined product. Possible reserves were estimated at 17.6 million tonnes averaging 92.4 per cent magnesia in calcined product (Schultes, 1986). Since 1982, the company has produced high quality caustic magnesia and in 1988 it built a new plant, with the capacity of 14 000 tonnes per year of fused magnesia (O'Driscoll, 1989).

TECTONIC SETTING

The Mount Brussilof deposit is located in the Fore-

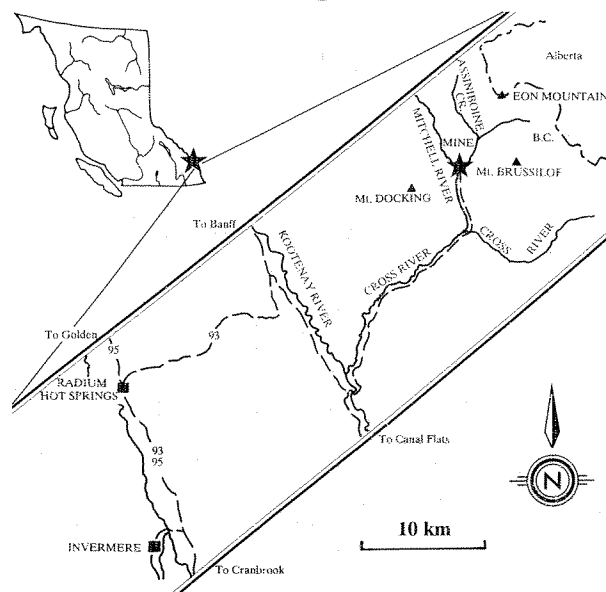

Figure 1. Location of the Mount Brussilof magnesite mine.

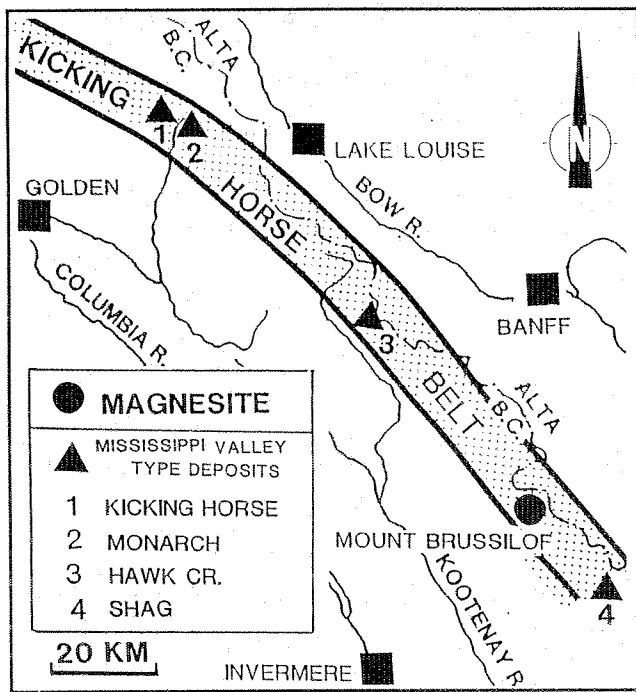

Figure 2. Relative positions of the belt encompassing the limits of the Kicking Horse Rim through Cambrian time (from Aitken, 1971), Mississippi Valley-type base metal deposits (from Höy, 1982), and Mount Brussilof magnesite deposit.

land Belt and within the "Kicking Horse Belt" (Figure 2), which encompasses the limits of a temporal shifting of an elongated Cambrian bathymetric feature, initiated in lower Cambrian times as a tectonic welt, commonly referred to as the Kicking Horse Rim (Aitken, 1971). The Cathedral Escarpment corresponds to the steep southwestern fringe of the Kicking Horse Rim (Aitken, 1971; Fritz, 1990; Aitken and McIlreath, 1984, 1990). Existence of the Escarpment is challenged by Ludwigsen (1989, 1990) who suggests that this feature is a shale-carbonate facies change on a ramp. Leech (1966) described the same feature in the Mount Brussilof mine area (Figure 3) as a "faulted facies change". The Cathedral Escarpment possibly corresponds to a syn-sedimentary fault; carbonate rocks east of this feature host the magnesite mineralization and were deposited in a shallower marine environment than their stratigraphic equivalents to the west.

STRATIGRAPHY AND LITHOLOGY

The stratigraphic relationship between rocks east of the Cathedral Escarpment and their deeper water equivalents to the west, commonly referred to as the Chancellor Formation, is described by Aitken and McIlreath (1984), Stewart (1989) and Simandl and Hancock (1990).

All known occurrences of sparry carbonate, other than veins of calcite or dolomite a few centimeters in thickness, are located east of the Cathedral Escarpment. The formations outcropping east of the Cathedral Escarpment are described below in order from oldest to youngest (see Figures 3 and 4).

The Gog Formation is a rusty, grey or buff, medium to coarse-grained, massive to decimeter-scale bedded Lower Cambrian quartzite over 250 metres thick.

LEGEND







Middle Cambrian

- 7 **Chancellor Formation:** Argillaceous limestone and shales. Basinal equivalent of the Pika, Eldon, Stephen and Cathedral formations
- 6 **Arctomys Formation:** Purple and red shales with beige dolomite. Overlain by the Waterfowl and Sullivan formations.
- 5 **Eldon and Pika formations (undivided):** Buff, grey and black massive dolomite, argillaceous dolomite and limestone.
- 4 **Stephen Formation:** Brown and tan shales. Fossiliferous.
- 3 **Cathedral Formation:** Buff and grey dolomite and limestone
- 2 **Naiset Formation:** Thin-bedded, brown and green shale.

Lower Cambrian

- 1 **Gog Formation:** Massive, tan, quartz sandstone.

SYMBOLS

-  Open pit
-  Magnesite
-  Sparry carbonate
-  Magnesite (Leech, 1966)
-  Cathedral Escarpment
-  Geological contact: defined, approximate, assumed
-  Fault: defined, approximate

The Naiset Formation consists of millimetre to centimetre-scale bedded, brown and green Middle Cambrian shale overlying the Gog Formation. The formation is 65 to 170 metres thick. It is characterized by blue-green chlorite spots and a well developed cleavage moderately oblique to bedding. Near the Cathedral Escarpment this shale may be grey, and partially converted to talc and serpentine.

The Cathedral Formation, which hosts the high-grade magnesite deposits, is also Middle Cambrian in age. It is about 340 metres thick and consists of buff, white and grey limestones and dolomites. A wide variety of sedimentary and diagenetic textures are preserved, including laminations (Plate 2), ripple marks, intraformational breccias, *yoholaminites* as defined by

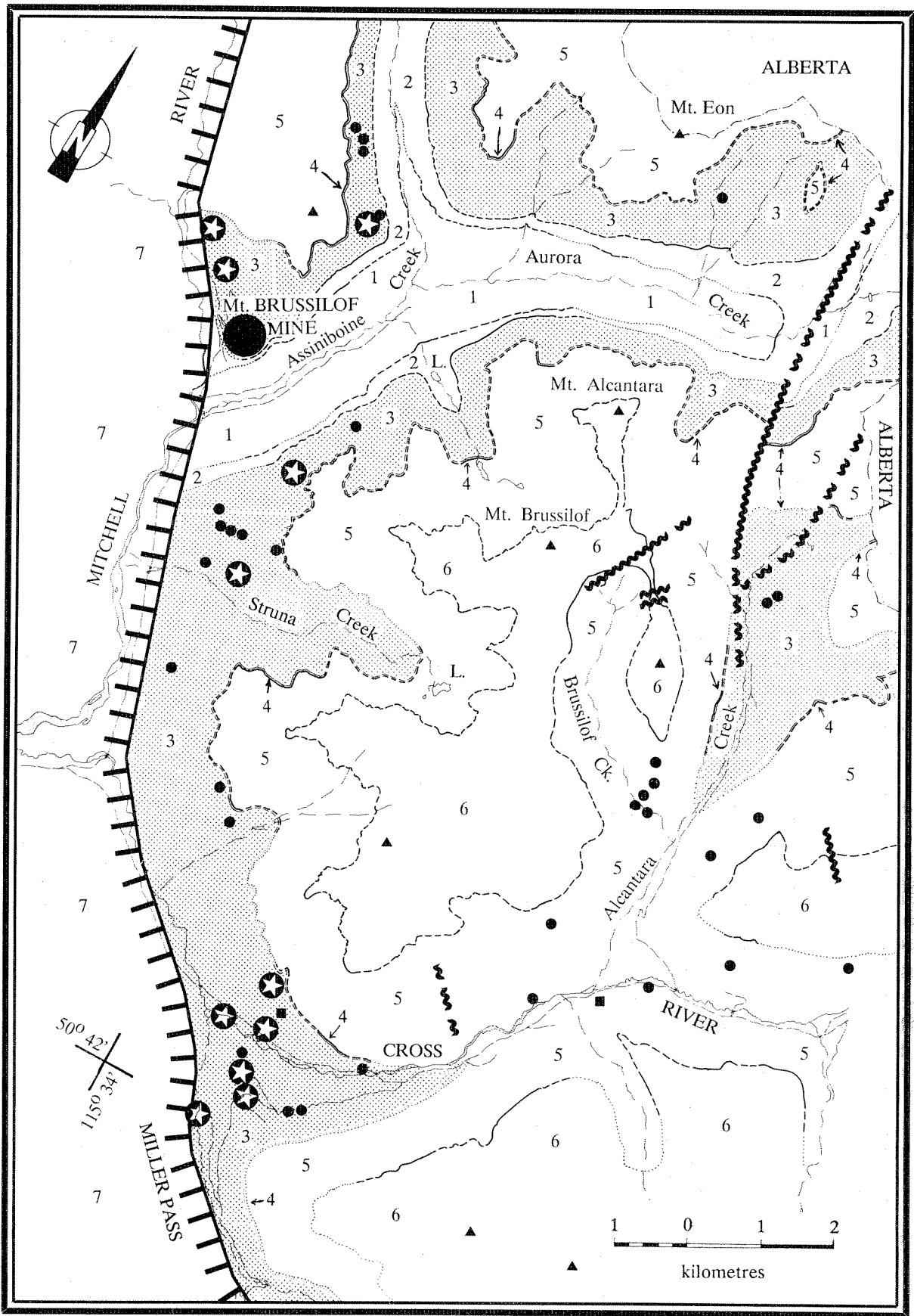

Figure 3. Geology of the Mount Brussilof mine area.

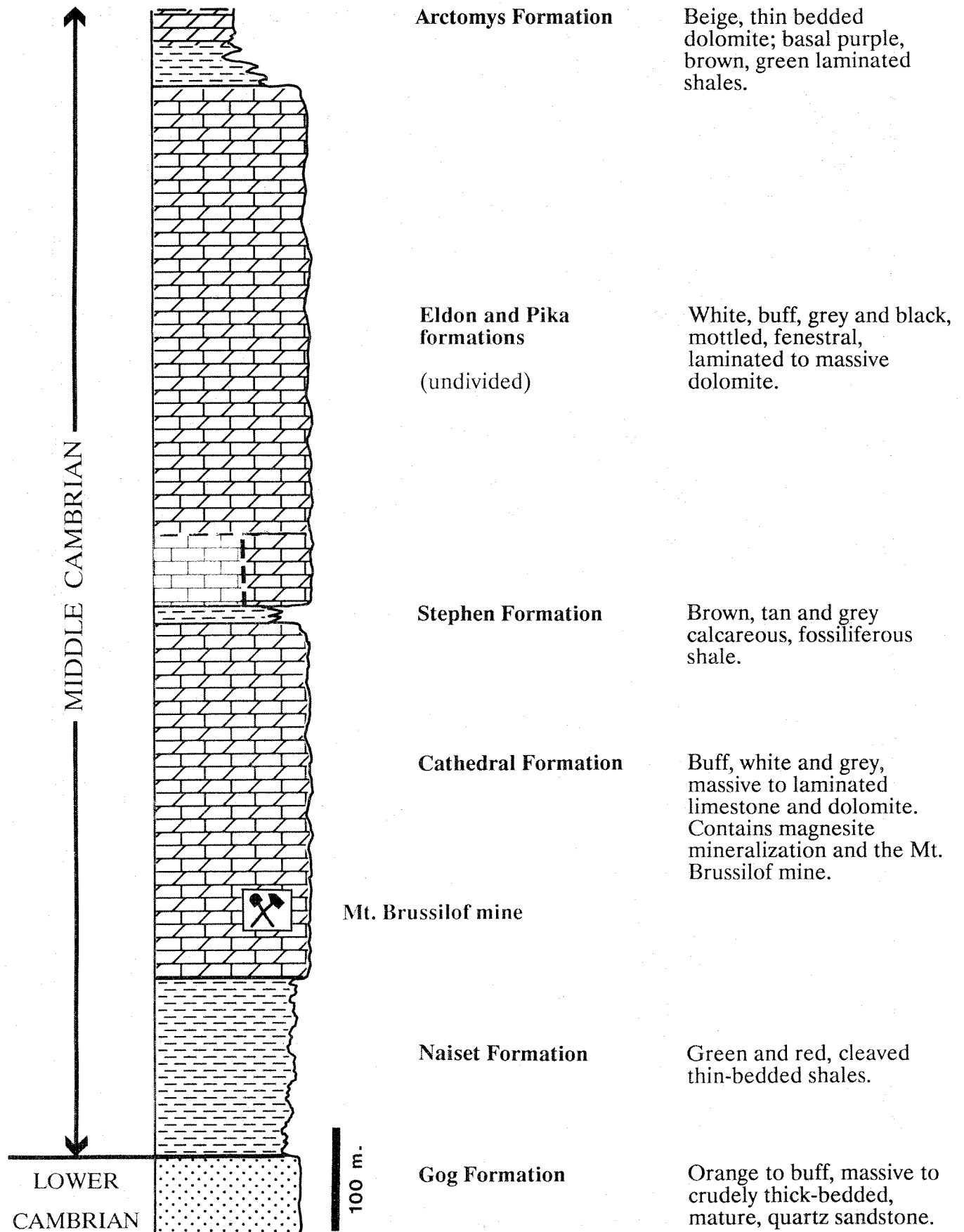

Figure 4. Composite stratigraphic column of the sedimentary sequence east of the Cathedral escarpment, Mount Brussilof mine area (simplified from Stewart, 1989).

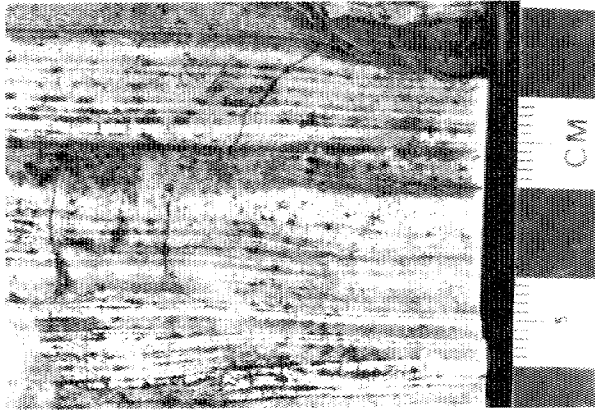

Plate 2. Finely laminated dolomite; top of Cathedral Formation.

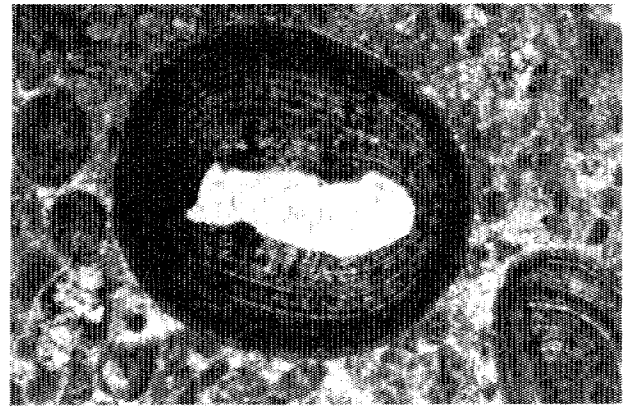

Plate 3. Pisoliths and oololiths; field of view is 4.6 mm; Cathedral Formation.

McIlreath and Aitken (1976), algal mats, pisoliths and oololiths (Plate 3), fenestrae, burrows and grapestone textures, polygonal dessication mud cracks and spindle synaeresis cracks. Pyrite is common either as disseminations or pods and veins.

The Stephen Formation consists of tan to grey, thinly bedded to laminated shale about 16 metres thick, with a cleavage subparallel to bedding. It is middle Cambrian in age and contains abundant fossil fragments and locally well preserved trilobites and inarticulate brachiopods. Near the sparry magnesite deposits this shale may contain talc or serpentine.

The Eldon and Pika Formations cannot be subdivided within the map-area. The lowermost beds of the Eldon Formation, which overlie the Stephen Formation, are black limestones approximately 50 metres thick. This distinctive basal unit contains millimetre to centimetre scale argillaceous layers which weather to a red, rusty colour. Elsewhere, these formations are not readily distinguished from the Cathedral Formation except by fossil evidence.

The Arctomys Formation, also Middle Cambrian, is characterized by green and purple shales and siltstones interbedded with beige, fine-grained dolomites. Mud cracks and halite crystal-prints are commonly preserved. The thickness of this formation was not determined, as the base of this formation marked the upper limit of our mapping.

All the formations except the recessive Stephen Formation are well exposed in the map-area. The Stephen Formation was not observed in the southern part of the map-area (Figure 3). It is not clear if the lack of exposure is due to its recessive nature or non-deposition as indicated by the assumed contact symbol. Dissolution breccias, cemented by white sparry dolomite, are well developed within the Cathedral Formation in this area. Non-deposition is possible since similar breccias are interpreted as karst features and are commonly overlain by unconformities in Mississippi Valley-type deposit districts (Sangster, 1988).

STRUCTURE:

The mapped area was subdivided into eight domains (Figure 5) to document the variations in the tectonic

styles east and west of the Escarpment and to compare the morphology of the magnesite bearing formations immediately adjacent to the Escarpment and farther east of the Escarpment. The rocks west of the Cathedral Escarpment (Domain I; Figures 5 and 6), belong to the Chancellor Group and are strongly deformed. They strike 160° dipping mainly to the west. The deformation style is characterized by numerous small and large scale folds, of metre to kilometre wavelength which are overturned to the east with subhorizontal fold axes oriented 160° . A well-developed, steeply dipping cleavage striking 160° and minor thrust faults dipping gently to the west are typical features of this domain.

Along the Cathedral Escarpment, subvertical cleavage trending north-south is closely spaced and injected by dolomite, calcite and ankerite(?) veins.

East of the Cathedral Escarpment, cleavage is generally absent in carbonates of the Cathedral, Eldon and Pika formations, but is well developed in the rocks of Stephen Formation and strongly developed in the Naiset Formation. The rocks cropping out in the proximity of the mine (Domain II) immediately east of the Cathedral Escarpment strike $168/21SW$. Rocks south of the mine area (Domains III and IV; Figures 5 and 6) strike approximately east-west, and dip 10° to the south.

Farther to the east (Domains V, VI and VII; Figures 5 and 6), bedding is subhorizontal and characterized by minor, upright, open folds. Several subvertical north trending faults were observed in domains VII and VIII (Figures 3 and 5). These faults have apparent vertical displacements of tens to hundreds of metres. The orientation of the cleavage in domains II to VII varies slightly as shown on Figure 6. This variation may be a consequence of the late, minor open folding previously described.

In the northeastern corner of the study area (Domain VIII), the deformation style in the Naiset Formation is similar to that of the Chancellor Formation (Domain I). Quartzite breccia in the Gog Formation is cemented by fine to medium-grained carbonates within this domain, and in the proximity of the largest fault (Figure 3).

In summary we can say that no obvious differences were found between the tectonic domains, where carbonate formations host magnesite and where they are bar-

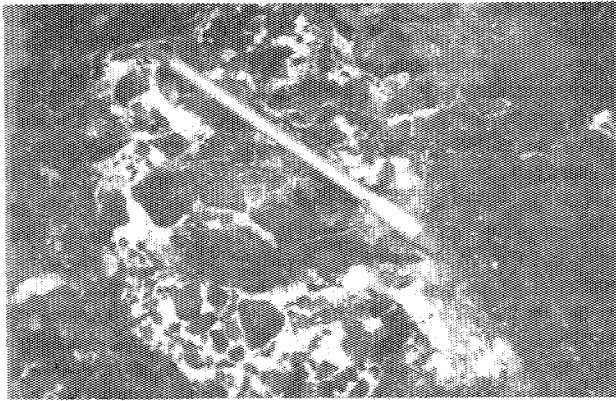

Plate 4. Dark grey dolomite fragments cemented by coarser white dolomite; Cathedral Formation.

ren. However in the immediate proximity of the Mount Brussilof deposit the dip of these formations is the steepest (Domain II, Figures 5 and 6).

PETROGRAPHY OF MAGNESITE-BEARING ROCKS

Sparry carbonate rocks occur within shallow depositional facies of the Cathedral, Eldon and Pika formations (Figures 3 and 4). They consist mainly of coarse dolomite

and magnesite crystals in varying proportions. Magnesite-rich sparry carbonates are restricted to the Cathedral Formation in which they form lenses, pods and irregular masses.

Sparry carbonates are separated from limestone by pale grey, massive dolomite which may contain needle-shaped quartz crystals. The contacts between sparry carbonate masses and fine-grained dolomite are sharp and may be concordant or discordant to bedding (Plates 5 and 6).

Magnesitic sparry carbonate is usually white or pale grey and weathers buff in colour. It consists of regularly spaced, alternating white and grey magnesite layers, randomly oriented centimetre-scale white magnesite crystals (Plate 7) or a mixture of pale grey and white magnesite crystals. Common impurities in magnesite ore are isolated rhombohedral dolomite crystals, calcite veins, pyrite veins and subvertical fractures. The fractures are filled by a mixture of beige ankerite, calcite and chlorite. Coarse radiating or individual quartz crystals and coarse pyrite pyritohedrons and octahedrons disseminated within sparry magnesite. Tetrahedrite, malachite, fersmite, phlogopite, talc and coarse, white, acicular palygorskite were also observed at the Mount Brussilof mine. Boulangerite, huntite and brucite are reported from studies by White (1972) and pentlandite, leuchtenbergite and muscovite are reported by Schultes (1986).

Fine-grained dolomite, which is not entirely converted to magnesite, commonly contains replacement features such as coarse, white carbonate crystals growing perpendicular to fracture planes or partings and lenses of fine-grained dolomite enclosed by sparry carbonates. Bipolar growths of zoned magnesite crystals, magnesite pinolite (Plate 8), rosettes as well as "zebra magnesite" rock are interpreted as replacement textures. Sparry dolomite rocks consist mainly of dolomite rhombs which form lenses, veins or irregular masses in fine grained dolomite and occur at the same stratigraphic horizons and contain the same impurities as sparry magnesite. At the Mount Brussilof mine magnesite ore is cut by dolomite veins, however, magnesite veins were not observed to cut sparry dolomite.

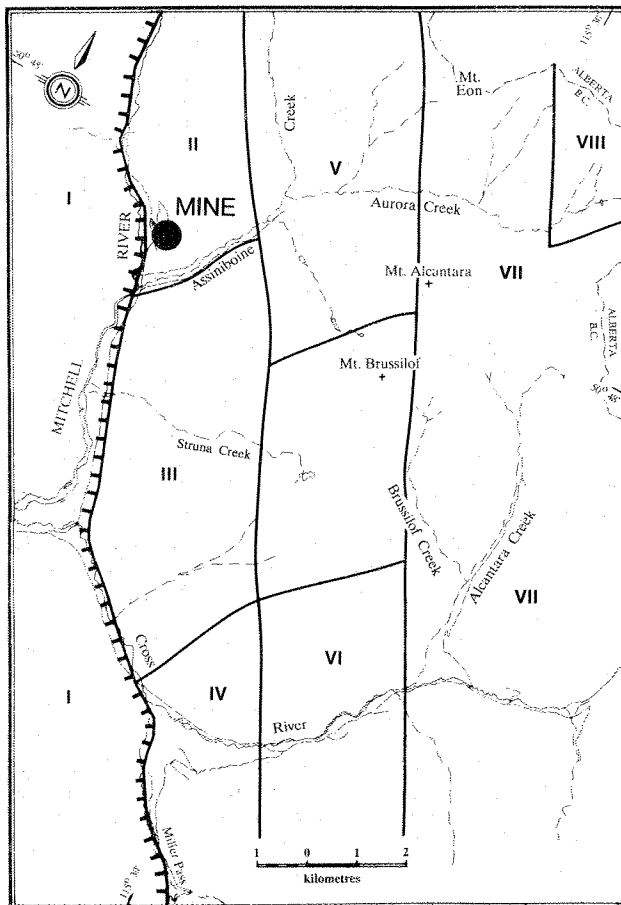

Figure 5. Structural domains; area covered by Figure 3.

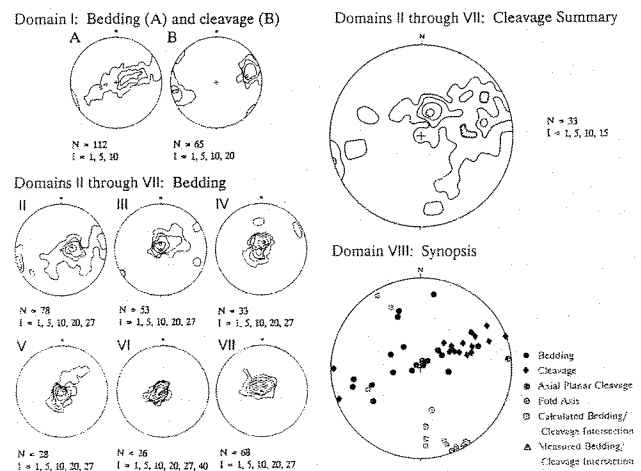

Figure 6. Structural synthesis; Mount Brussilof area.

CARBONATE ROCKS CHEMISTRY

Nineteen samples of magnesite and dolomite-bearing rocks were analyzed for MgO, CaO, FeO, SiO₂ and Al₂O₃. The major constituents are MgO and CaO, which are inversely correlated (Figure 7). The magnesium content of the carbonate rocks varies continuously from dolomite to magnesite. Stoichiometric dolomite and magnesite are shown for reference in Figure 7. The magnesia content varies according to grain size. Fine-grained massive or laminated carbonates are dolomitic in composition while coarse and sparry carbonates have higher magnesia contents.

GENETIC LINKS

There is a possible genetic link between sparry magnesite deposits and Mississippi Valley-type lead-zinc deposits.

The spatial association of the Mississippi Valley-type lead-zinc deposits with the Cathedral Escarpment (Figure 2) has long been known (Höy, 1982; Aitken and McIlreath, 1984). The Cathedral Escarpment may be regarded as a "hinge line" as defined in Sangster (1984). Intense dolomitization and cementation of breccias by white sparry dolomite at the Kicking Horse Mine, de-

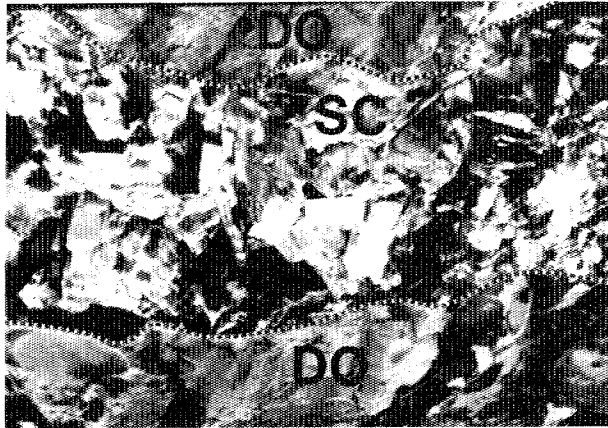

Plate 5. Concordant contacts between sparry carbonate (SC) and fine-grained dolomite (DO); Cathedral Formation.

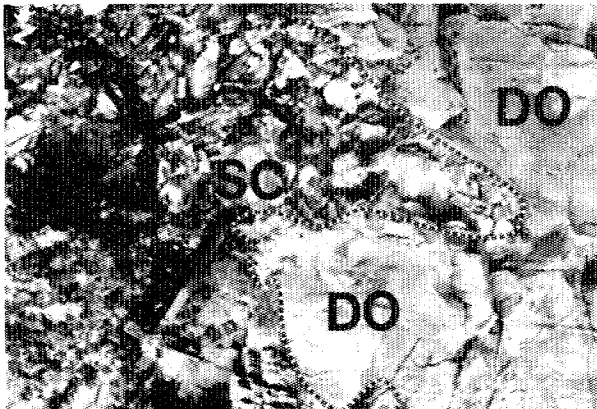

Plate 6. Discordant, sharp and irregular contact between sparry carbonate (SC) and fine-grained dolomite (DO); Cathedral Formation.

scribed by Rassetti (1951) and Höy (1982), are also present in the Mount Brussilof area.

Mississippi Valley-type deposits (Höy, 1982), as well as magnesite and sparry dolomite deposits may be genetically related to this feature.

The abundance of pyrite in the Mount Brussilof area, facies changes, a possible local unconformity (absence of the Stephen Formation south of the Mount Brussilof deposit), sparry nature of the carbonates and replacement textures observed in the Mount-Brussilof are features commonly observed within the classical Mississippi Valley-type districts described by Sangster (1988). These features support the suggestion by Simandl and Hancock (1991) that magnesite deposits at Mount Brussilof may have formed by extreme dolomitization of fine-grained carbonates.

PROPOSED GENETIC MODEL

Elements of a genetic model explaining the origin of the Mount Brussilof deposit are indicated by the tectonic, stratigraphic and structural settings, geographic and stratigraphic association with the Mississippi Valley type-deposits, secondary porosity features, replacement textures, mineral paragenesis and absence of fine-grained magnesite (Simandl and Hancock, 1991). Magnesite appears to postdate early diagenesis of the Cathedral Formation and probably of the Stephen, Eldon and Pika formations as well. Widespread dolomitization, subsequent fracturing and brecciation contributed significantly to an increase in porosity. Some of the fracturing may have resulted from reactivation of a pre-Cathedral Escarpment fault or to a difference in competence between deep and shallow-water sediments during post-middle Cambrian tectonic activity. However, most breccias are probably products of partial dissolution and collapse of the carbonate host rock caused by incursion of meteoric water or hydrothermal solutions in the manner described by Sangster (1988).

Fluids responsible for crystallization of coarse sparry carbonates reacted with the dolomitized, permeable and fractured reef facies along the Cathedral Escarpment and moved up-dip along permeable zones. The fluids cooled and evolved chemically due to interaction with wall rock along their flow paths. This model suggests that

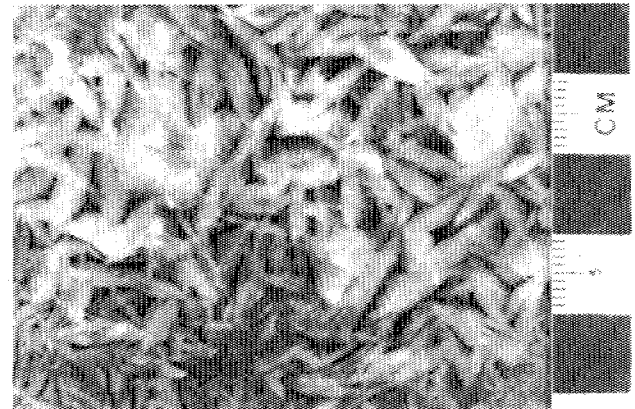

Plate 7. Randomly oriented sparry magnesite crystals; Cathedral Formation, 100 metres east of the Mount Brussilof mine.

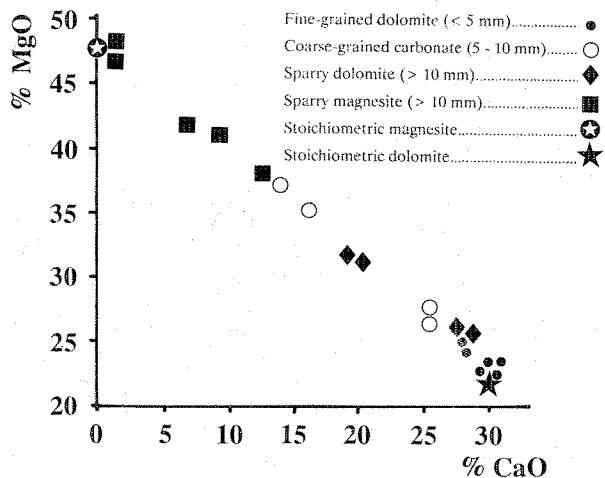

Figure 7. Negative correlation between CaO and MgO in carbonate rocks, Mount Brussilof area. Coarse-grained and sparry dolomites have higher MgO content than fine-grained carbonate rocks.

the largest and highest grade magnesite deposits should occur along the edge of the Cathedral Escarpment within the reef facies. Lower-grade sparry magnesite and sparry dolomite deposits would occur further up-dip, either along the same permeable zones, eastward from the Cathedral Escarpment, or in other zones east and adjacent to the Escarpment (Simandl and Hancock, 1991).

If this model is correct, the origin of sparry magnesite deposits in the Mount Brussilof area can be explained as an extreme case of dolomitization, genetically related to the same hydrothermal system as Mississippi Valley-type deposits associated with the Kicking Horse Rim. However, since the Cathedral Escarpment overlies a tectonic welt of lower Cambrian age (Aitken, 1971), the possibility exists that the Mg^{2+} rich fluids unrelated to Mississippi Valley-type deposits rose along reactivated, possibly syn-sedimentary, faults of the older lower Cambrian tectonic welt. Regardless of the ultimate origin of the fluids, the proposed mechanism for the formation of the magnesite deposits is presented in the phase diagram of Figure 8. It shows the relationship between temperature and $M Ca^{2+} / M Mg^{2+}$. Composition of typical sea-

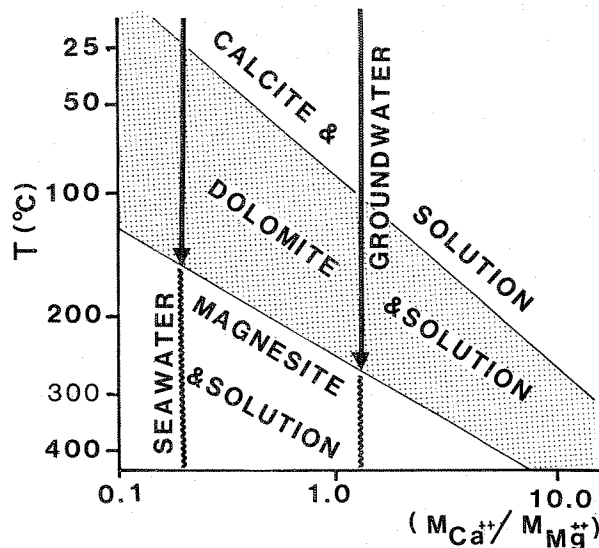

Figure 8. Potential of a 1 mole chloride solution to convert carbonates into magnesite as a function of $M Ca^{2+} / M Mg^{2+}$ ratio and temperature. (after Wilson et al. (1990), data extrapolated from Rosenberg, Burt and Holland (1967)).

water and groundwater are indicated by the vertical lines. Referring to this diagram limestone can be dolomitized by reaction with typical seawater at temperatures as low as 25°C and dolomite may be converted to magnesite at temperatures of the order of 150°C or higher. Should the magnesite forming fluid had a lower $M Ca^{2+} / M Mg^{2+}$ ratio, then temperatures slightly above 100°C would have sufficed to convert dolomite to magnesite. These temperatures are within the range of the fluid inclusion studies reported for Mississippi Valley type deposits reported by Sangster (1990). Substantially higher temperatures would have been required if the fluid had $M Ca^{2+} / M Mg^{2+}$ ratio of typical groundwater (Figure 8).

The proposed model requires confirmation and integration with petrographic work, fluid inclusion and crystallinity studies, geochemical (isotopic, rare earth, minor and major element) analysis and thermodynamic considerations. Future studies will consider the origin, temperature and composition of the mineralizing fluid, geochemical gradients, paragenetic relationships and fluid/rock ratios.

SUMMARY AND CONCLUSIONS

The Mount Brussilof area and carbonate rocks of the Kicking Horse Belt have excellent potential to host other high-grade magnesite deposits, as well as lower-grade/large-tonnage "magnesitic dolomite" deposits. The origin of sparry magnesite-bearing rocks can be explained as an extreme case of dolomitization, possibly genetically related to the same hydrothermal system as Mississippi Valley-type deposits associated with the Kicking Horse Rim.

Fluids responsible for crystallization of coarse sparry carbonates reacted with the dolomitized, permeable and fractured reef facies along the Cathedral Escarpment and moved up-dip along permeable zones.

If the model is correct, then the entire Kicking Horse Belt and Rob Lake trend of Mississippi Valley-type de-

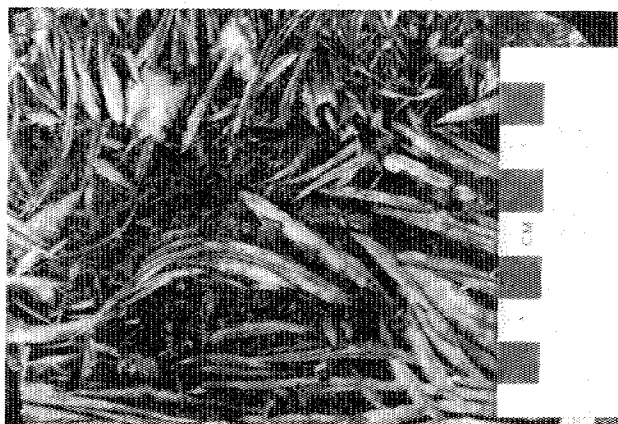

Plate 8. Magnesite pinolites (light grey) growing within a fine-grained dolomite matrix; Mount Brussilof mine.

posits in northern British Columbia, as well as other Mississippi Valley-type districts could be considered favorable exploration areas for magnesite.

ACKNOWLEDGMENTS

Baymag Mines Co. kindly provided access to company information and facilities during the 1990 field season. Special thanks are extended to H. Fergen, Mine Manager, and I. Knuckey, Mine Geologist for their cooperation and assistance. R. Matthew, Consulting Engineer directed our attention to the mineralogical particularities of the Mount Brussilof mine. We thank Dr. A. Panteleyev, Mr. K.J. Mountjoy and Mr. B. Grant of the B.C. Geological Survey Branch for constructive reviews of earlier versions of this paper.

REFERENCES:

- Aitken, J.D. (1971): Control of Lower Paleozoic Sedimentary Facies by the Kicking Horse Rim, Southern Rocky Mountains, Canada; *Bulletin of Canadian Petroleum Geology*, Volume 19, pages 557-569.
- Aitken, J.D. (1989): Birth, Growth and Death of the Middle Cambrian Cathedral Lithosome, Southern Rocky Mountains; *Canadian Petroleum Geology*, Bulletin, Volume 37, pages 316-333.
- Aitken, J.D. and McIlreath, I.A. (1984): The Cathedral Reef Escarpment, a Cambrian Great Wall with Humble Origins; *Geos*, Volume 13, pages 17-19.
- Aitken, J.D. and McIlreath, I.A. (1990): Comment on "The Burgess Shale: Not in Shadow of the Cathedral Escarpment"; *Geoscience Canada*, Volume 17, pages 111-115.
- Coope, B. (1987): The World Magnesia Industry; *Industrial Minerals*, Number 223, pages 21-31.
- Couturier, G. (1989): Magnesium; in 1989 Canadian Minerals Yearbook, Mineral Report No.38, Mineral Policy Sector, *Energy Mines and Petroleum Resources*, pages 37.1-37.17.
- Duncan, L.R. (1990): Magnesite; *Mining Engineering*, Volume 191, Number 6, page 569.
- Fritz, W.H. (1990): Comment: In Defence of the Escarpment near the Burgess Shale Fossil Locality; *Geoscience Canada*, Volume 17, pages 106-110.
- Grant, B. (1987): Magnesite, Brucite and Hydromagnesite Occurrences in British Columbia; *B.C. Ministry of Energy, Mines and Petroleum Resources*, Open File 1987-13, 68 pages.
- Höy, T. (1982): Stratigraphic and Structural Setting of Stratabound Lead-Zinc Deposits in Southeastern B.C.; *Canadian Institute of Mining and Metallurgy*, Bulletin, Volume 75, No. 840, pages 114-134.
- Leech, G.B. (1965): Kananaskis Lakes, W. 1/2 Area; in Report of Activities, May to October, 1965, *Geological Survey of Canada*, Paper 66-1, pages 65-66.
- Leech, G.B. (1966): Kananaskis Lakes; *Geological Survey of Canada*, Open File 634, map.
- Ludwigsen, R. (1989): The Burgess Shale : Not in the Shadow of the Cathedral Escarpment; *Geoscience Canada*, Volume 16, pages 139-154.
- Ludwigsen, R. (1990): Reply to Comments by Fritz and Aitken and McIlreath; *Geoscience Canada*, Volume 17, pages 116-118.
- MacLean, M.E. (1988): Mount Brussilof Magnesite Project, Southeast British Columbia (82/13E); in Geological Fieldwork, *B.C. Ministry of Energy, Mines and Petroleum Resources*, Paper 1989-1, pages 507-510.
- McIlreath, I.A. and Aitken, J.D. (1976): *Yoholaminites* (Middle Cambrian) Problematic Calcareous Sediment-stabilizing Organism; *Geological Association of Canada*, Program with Abstracts, 1976 Annual Meeting, page 84.
- Rasetti, F. (1951): Middle Cambrian Stratigraphy and Fauna of the Canadian Rocky Mountains; *Smithsonian Miscellaneous Collections*, Volume 116, Number 5, 277 pages.
- Sangster, D.F. (1990): Mississippi Valley-type and Sedex Lead-Zinc Deposits: a Comparative Examination; *Transactions of the Institution of Mining and Metallurgy (Section B: Applied Earth Science)*, Volume 99, pages B21-B42.
- Sangster, D.F. (1988): Breccia-Hosted Lead-Zinc Deposits in Carbonate Rocks; in Paleokarst, James, N.P. and Choquette, P.W., Editors, *Springer-Verlag New York Inc.*, pages 102-116.
- Sangster, D.F. (1984): Mississippi Valley Lead-Zinc; in Canadian Mineral Deposit Types: A Geological Synopsis, ed. Eckstrand, O.R., *Geological Survey of Canada*, Economic Geology Report 36, page 25.
- Schultes, H.B. (1986): Baymag - High Purity MgO from Natural Magnesite, *Canadian Institute of Mining and Metallurgy*, Bulletin, May 1986, pages 43-47.
- Simandl, G.J. and Hancock, K.D. (1991): Geology of the Mount Brussilof Magnesite Deposit, Southeastern British Columbia, *B.C. Ministry of Energy, Mines and Petroleum Resources*, Geological Fieldwork 1990; Paper 1991-1, pages 269-278.
- Simandl, G.J., Hancock, K.D., Paradis, S. and Simandl, J. (1991): Field Identification of Magnesite-bearing Rock using Sodium Polytungstate (in preparation).
- Stewart, W.D. (1989): A Preliminary Report on Stratigraphy and Sedimentology of (Middle to Upper Cambrian) in the Zone of Facies Transition, Rocky Mountain Main Ranges, Southeastern British Columbia; in Current Research, Part D, *Geological Survey of Canada*, Paper 89-1D, pages 61-68.
- White, G. P. E. (1972): Mineralogy of the Baymag Mines Ltd. Magnesite Prospect, South Kootenay Area, B.C.; unpublished report, *Acrers Western Limited*, 17 pages.

ENVIRONMENTAL SIGNIFICANCE OF MAGNESIUM OXIDE AS AN INDUSTRIAL MINERAL

By Tim Sears and Hagen Schultes

Baymag, Calgary, Alberta

ABSTRACT

Magnesium is the eighth most abundant element in the earth's crust. In a commercial sense, it occurs predominantly as magnesite ore in sedimentary rocks or as a component of seawater. Industrial applications require converting these naturally occurring into more useful forms.

The primary conversion process produces magnesium oxide. Subsequent applications utilize the basic properties of this oxide either to neutralize unwanted acidic materials or to react with feedstock to generate useful products.

This paper outlines the fate of magnesium in the environment. This will be contrasted with that of competitive materials whose environmental impact is much less benign.

INTRODUCTION

Magnesium is the eighth most abundant element in the earth's crust. It is available from a number of sources including minerals, salt brines and seawater. While magnesium occurs in a number of minerals, including dolomite, olivine and magnesite; commercial development of magnesium from minerals is primarily from magnesite deposits.

Magnesite (magnesium carbonate) is typically decomposed by calcination temperatures in the range of 750° to 1200°C. This releases carbon dioxide and leaves magnesium in the more concentrated form of magnesium oxide.

Magnesium values from salt brines and seawater can be recovered in several different forms, depending on the intended market application. The primary recovered forms are magnesium chloride and magnesium hydroxide, although a variety of sulfate salts can also be obtained. For either brines or seawater, a basic chemical, such as lime, dolomite lime, or caustic acid, is used to raise the alkalinity (pH) of the solution until magnesium hydroxide is precipitated. This can be represented by the reaction equation:

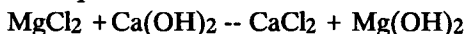

Magnesium hydroxide is a base and can either be used directly or calcined to magnesium oxide at decomposition temperatures greater than 400°C. This releases water as a vapour and leaves the magnesium values in the more concentrated form of the magnesium oxide.

The market for calcined magnesium oxide includes a variety of in different industries. These include the following:

- mineral supplements in the animal feed industry,
- pulping liquor in the pulp and paper industry,
- processing aids in the production of cellulose acetate,
- raw material in the production of pharmaceuticals,

an acid neutralizing agent in the treating of waste and in recycling water.

Most of these applications utilize the basic properties of magnesium oxide or hydroxide to neutralize an acid (e.g. sulfuric, hydrochloric, nitric or acetic acids) and to generate a useful salt such as magnesium sulfate, magnesium chloride, magnesium nitrate or magnesium acetate.

PERSPECTIVE ON NEUTRALIZATION

Common alkaline bases can be compared in terms of their ability to accept hydrogen ions. The most common set of reactions is to react with, or neutralize, acids containing hydrogen ions. If a given unit (mole) of base can neutralize one mole of hydrogen ions it is termed a monoacid base. The terms di and tri-acid bases are similarly defined. The concepts of mono, di and tri-basic acids are similarly developed from the perspective of the acid.

The measure of the amount of hydrogen ion available (or deficient) is given by the technical concept of pH. Various federal, state/provincial and municipal government agencies mandate the allowable pH for discharge. While pH requirements for recycled water are subject to a different set of constraints, in general terms, excessively high or low pH values are associated with corrosion and/or fouling of process lines. Thus for either environmental control or economic considerations, the use of bases for pH control is a significant application.

If we compare magnesium with the other common alkaline bases - sodium and calcium - we see the similarities shown in Figure 1. All occur naturally in their carbonate forms: sodium as sodium carbonate (soda ash), commonly occurring as trona ore; calcium as calcium carbonate, commonly known as limestone; and magnesium as magnesium carbonate, commonly known as magnesite. All can in principle be calcined from carbonate to oxide, and all can be hydrated from oxide to hydroxide.

The oxides are typically produced by calcination of either the carbonates or hydroxides. Sodium oxide, how-

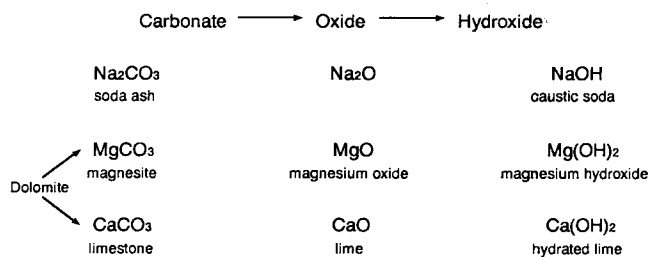

Figure 1. Relationships among bases derived from sodium, magnesium and calcium.

ever, is not usually isolated for market because of its reactivity.

The hydroxides are generated by a variety of processes. Sodium hydroxide is generated by the electrolysis of salts, with cogeneration of chlorine by the chlor-alkali process. Environmental concerns about chlorine have reduced its usage and consequently led to a tightening of caustic soda production. This has been accompanied by increasing prices for caustic soda.

Magnesium hydroxide is generated by precipitation from brines or seawater. Principal brine sources are in Michigan, Utah and Texas. Neutralization of magnesium hydroxide with hydrochloric acid forms the basis for the Dow process for generating magnesium metal.

Calcium hydroxide is generated by hydration of calcium oxide in a process called slaking. Slaking of magnesium oxide is the basis for Baymag's successful participation in a segment of the pulp and paper market.

ACID NEUTRALIZATION FOR ENVIRONMENTAL CONTROL

Magnesium, sodium, and calcium in their respective carbonate, oxide and hydroxide forms are the most commonly used neutralizing agents for environmental control. Although these bases are effective at neutralization, significant differences exist:

- the different bases vary in their ability to neutralize a given amount of acid;
- each of these bases occurs in different physical form and some may be supplied in a variety of physical forms depending upon end-user requirements;
- environmental impact or water treatment concerns may affect the criteria used to select which base is more appropriate;
- either alone or in combination with the above, costs of the different materials vary for both plant-price and transportation.

The selection of a base for neutralizing an acidic material must therefore be the result of a cost-benefit analysis which includes environmental impact as well as the cost of neutralization. These factors have led to increasing market demand for both magnesium oxide and hydroxide especially in niche applications. The differences are examined below in detail. The pH adjustment for heavy metal removal is another significant

application of bases for environmental control, but this application will not be discussed in this paper.

NEUTRALIZING ABILITY

Among the more common acids in waste water streams, which must be neutralized before being discharged are hydrochloric acid (monobasic) and sulfuric acid (dibasic). The reactions for the common bases under consideration (*see* Figure 1) are represented in Tables 1 and 2. These reactions determine the ratios in which the acids and bases combine or neutralize.

While these combining ratios, or stoichiometries, determine the number of units that combine, each unit has a different molecular weight depending on which particular acid and base combination is involved. It is, therefore, useful to tabulate the relative amounts of alternative bases required to neutralize a given amount of a particular acid as well as the ratios of these relative base requirements. These ratios are commonly referred to as equivalent-basicity factors. For the bases under consideration these factors are tabulated in Table 3. On a pound for pound basis less MgO is required than any of the other bases.

DIFFERENT PHYSICAL FORMS

The three relevant physical states in which these bases may be supplied are solid (powder), slurry (relatively insoluble powder suspended in water) and solution (relatively soluble powder dissolved in water).

For materials supplied in solid form, the most relevant property is purity. Competitive market conditions usually ensure comparable purities, although industry-standard purity levels may differ from material to material.

For slurries, relevant properties include purity of the solid as well as the solid loading in the water (*i.e.*, per cent solids). Solubility is rarely a concern for slurries because slurries are by definition relatively insoluble.

For solutions, the most relevant property is the concentration of neutralizing agent in solution. Once again, market requirements usually ensure standardization. Only one of the bases, caustic soda, has enough solubility over a sufficient range of concentrations to be supplied in solution form.

TABLE 1
SUMMARY OF REACTIONS OF DIFFERENT NEUTRALIZING AGENTS WITH HYDROCHLORIC ACID

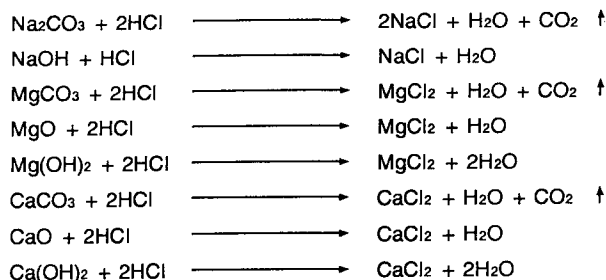

TABLE 2
SUMMARY OF REACTIONS OF DIFFERENT NEUTRALIZING AGENTS WITH SULPHURIC ACID

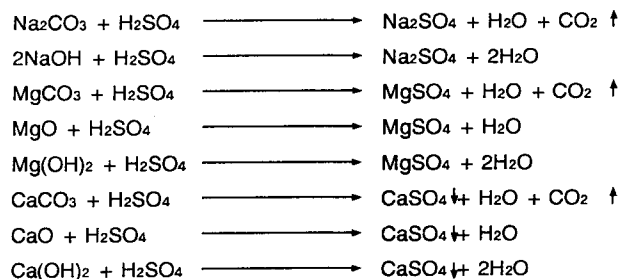

TABLE 3
RATIOS OF NEUTRALIZING AGENTS REQUIRED TO NEUTRALIZE A GIVEN ACID

Neutralizing Agent	Ratio of Agent Required Relative to Magnesium Oxide
MgO	1.00
Mg(OH) ₂	1.45
MgCO ₃	2.09
CaCO ₃	2.48
CaO	1.39
Ca(OH) ₂	1.84
Na ₂ CO ₃	2.63
NaOH	1.98

ENVIRONMENTAL AND TREATMENT CONCERNS

Due to the complexity of most chemical processes, most proposals for treating acidic waste water streams for discharge are handled on a case-by-case basis. Three concerns, however, are common to most treatment situations: the alkalinity (pH) of the discharged water and the quantity and quality of any additional solids suspended or dissolved in the effluent.

Additional solids suspended or dissolved in the treated waste water will be determined by the acid and the base used for neutralization. In general terms, sodium salts are all soluble; magnesium salts, produced from both hydrochloric and sulfuric acid, are soluble; and, calcium salt of hydrochloric acid is soluble. The solubilities of the salts derived from the relevant bases are summarized in Table 4.

The calcium salt of sulfuric acid is relatively insoluble and produces a precipitate that adds to any sludge already present. Calcium sulfate also contributes to scaling of pipes, valves and pumps. This may create a market niche for neutralization using magnesium oxide or hydroxide where soluble salts are generated.

Sludge treatment is usually addressed on a case-by-case basis. The additional contribution of solids, either suspended or dissolved, is a balancing act. More or less sludge or precipitate will have consequences for the economics of the entire process.

In general terms, desired waste water stream pH

TABLE 4
RELATIVE SOLUBILITY OF SALTS FORMED FROM NEUTRALIZING HYDROCHLORIC AND SULFURIC ACIDS

MgCl ₂	VS
MgSO ₄	MS
CaCl ₂	VS
CaSO ₄	I
NaCl	MS
Na ₂ SO ₄	S

Key: VS = Very Soluble = > 40 kg. solute/kg. solution
MS = Moderately Soluble = 20 - 40 kg. solute/kg. solution
S = Soluble = 1 - 20 kg. solute/kg. solution
I = Insoluble = < 1 kg. solute/kg. solution

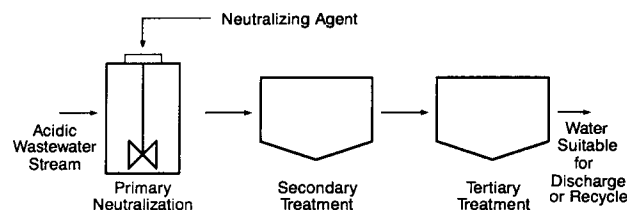

Figure 2. Generalized process flow for neutralizing an acidic waste water stream.

values fall in the range of pH = 5.5 to pH = 9. The neutralization curves of strong bases exhibit a very sharp response near the point of complete neutralization. The corresponding curves of weaker bases show a more flattened response. The desired response in most treatment applications is as fast as possible to keep residence time requirements (capital equipment expenditures) to a minimum. A corollary of an extremely fast response however, is the potential for overtreatment. Overtreatment in general refers to a pH greater than 9. Not only is this above the accepted standard for most discharge applications but it can lead to corrosion problems and can render biological agents ineffective in sewage treatment. Rates of neutralization and the potential for overtreatment are summarized in Table 5. Note that both limestone and magnesite are relatively slow reacting but have little potential for overtreatment. At the other extreme caustic soda is very fast but has a high potential for overtreatment.

PROCESS ECONOMICS - AN EXAMPLE

A generalized process flow diagram for neutralization is summarized in Figure 2. The following is a simplified case study based on this process.

The following example is for neutralizing an effluent stream containing sulfuric acid. Because the facility does not have sludge treatment the calcium bases have been excluded because of sludge formation. Clearly, the identity and loading of dissolved solids are major issues. Magnesite and limestone were excluded on the basis of unavailability and noncompetitiveness with alternatives with respect to treatment rate.

In this trial, a series of different neutralizing agents were studied and compared with caustic soda (NaOH, purchased on a 100% equivalent basis, received as a 50% liquid). The neutralizing agents are as follows:

TABLE 5
RATES OF NEUTRALIZATION AND POTENTIAL FOR OVERTREATMENT

Neutralizing Agent	Relative Rate of Neutralization	Level of Neutralization Obtainable (pH)
MgO	Moderately Fast	9 - 10
Mg(OH) ₂	Moderately Fast	9 - 10
MgCO ₃	Relatively Slow	4 - 7
CaCO ₃	Relatively Slow	4 - 7
CaO	Fast	12
Ca(OH) ₂	Fast	12
Na ₂ CO ₃	Moderately Fast	11
NaOH	Extremely Fast	14

TABLE 6
ANNUAL CHEMICAL COST OF
NEUTRALIZATION

Neutralizing Agent	Annual Requirement (Metric Tons)	Product Price (F.O.B. Plant; CDN\$/Metric Ton)	F.O.B. Point	Estimated Freight Cost (CDN\$/Metric Ton)	Annual Cost of Neutralization (CDN\$ x 1000)
MgO	1210	360	Alberta	10	435
Mg(OH) ₂	1750	250	Michigan	50 ÷ .58 ≈ 90	590
Na ₂ CO ₃	3180	115	Wyoming	60	560
NaOH	2400	390	Ontario	50 ÷ .50 ≈ 100	1180

- 1) magnesium oxide (MgO) powder, purchased as 97 per cent pure, received, as 50 per cent liquid,
- 2) magnesium hydroxide [(Mg(OH)₂] slurry, purchased on a 100 per cent equivalent basis, received as a 58 per cent slurry in water,
- 3) soda ash (Na₂CO₃) powder, purchased on a 100 per cent equivalent basis, received as a 58 per cent slurry in water,
- 4) current product, caustic soda (NaOH).

Neutralization consists of reacting one of these agents with the effluent containing sulfuric acid. The reactions are included in Table 2.

An annual requirement of 2 400 tonnes per year of caustic soda is the current consumption. Based upon the equivalent basicity factors from Table 3, the equivalent requirements for alternative neutralizing agents can be calculated.

The following ratios are presented as the amount of alternative neutralizing agent relative to the amount of caustic soda currently used:

Neutralizing Agent	Amount Required to Neutralize Relative to Caustic Soda
MgO	0.504
Mg(OH) ₂	0.729
Na ₂ CO ₃	1.325
NaOH	1

Based upon the client's current annual usage of caustic soda, the annual requirement for each alternative is presented below:

Neutralizing Agent	Annual Volume, 100% Basis (tonnes)
MgO	1210
Mg(OH) ₂	1750
Na ₂ CO ₃	3180
NaOH	2400

A summary of the alternative annual chemical costs of neutralization are presented in Table 6. Material costs are derived from published sources and industry estimates. The physical form of the various agents will also affect transportation costs.

It should be noted that a storage and handling system is required for alternate neutralizing agents to allow the end-user the flexibility of using powders or slurries instead of a liquid handling system. A summary of process economics including these capital costs, as well as environmental considerations, is presented in Table 7. Note

TABLE 7
SUMMARY OF PROCESS ECONOMICS

Neutralizing Agent	Form of Material	Annual Chemical Cost of Neutralization (CDN\$ x 1000)	Estimated Relative Capital Cost for Conversion of Handling and Storage Facilities	Environmental Impact Contribution to Total Dissolved Solids (Pounds per Ton of Acid Neutralized)
MgO	Powder	435	1	2460 as MgSO ₄
Mg(OH) ₂	Slurry	590	1	2460 as MgSO ₄
Na ₂ CO ₃	Powder	560	1	2900 as Na ₂ SO ₄
NaOH	Solution	1180	0	2900 as Na ₂ SO ₄

that the solids loading is lower with either of the magnesium bases.

SUMMARY

Although magnesium oxide and hydroxide account for less than 1 per cent of the neutralization market, they provide a growing alternative as more stringent environmental and economic conditions prevail. Their advantages in neutralization applications define a sizable market niche. Among these advantages are:

- higher neutralizing ability per unit of neutralizing agent,
- less potential for overtreatment,
- less contribution to neutralization solids,
- less corrosive than most competitive materials.

High purity magnesite (Schultes, 1986) can provide a neutralizing capability in either oxide or hydroxide form. Properly selected with due consideration for overall process consequences, magnesium oxide can prove an economical as well as an environmentally safe choice of neutralizing agent.

REFERENCES

- CRC Handbook of Chemistry and Physics; 63rd Edition, Robert C. Weast, ed., *CRC Press, Inc.*, Boca Raton, 1982.
- Magnesium oxide and hydroxide derived from: Mag Hydroxide Growth Seen in Caustic Soda Replacement; *Chemical Marketing Reporter*, April 22, 1991, page 5.
- Schultes, H.B. (1986): Baymag - high-purity magnesium oxide from natural magnesite; *Canadian Institute Mining and Metallurgy*; Bulletin, May, 1986.

MAGCAN AND MAGNESIUM

By A.H. Wheeler

The Magnesium Company of Canada plant site is located 5 kilometres north of High River, Alberta and 50 kilometres south of Calgary. The existing 12 500 tonne per year facility of magnesium metal production is the first module of five modules planned for the site. The plant produces high-grade (99.8%) primary magnesium metal and magnesium alloys. Most of the primary metal goes to the aluminum industry for alloying, while the magnesium alloys go to the die-casting industry.

MAGCAN purchases magnesite rock from the BAYMAG Mine near Radium B.C. The rock (150 - 12 millimetres, 6" - 1/2") is hauled under contract by truck to the plant site, a distance of 392 kilometres. The semi-trailer, plus a trailer, carried about 35 tonnes. The plant requires about 150 tonnes per day of rock (this is normally 6 trucks per day, 5 days a week). The plant maintains a two month stockpile of rock to cover the spring thaw and any emergency which might arise. The BAYMAG Mine will be covered by another paper so I will not describe it, except to say the rock is an excellent feed for a magnesium plant.

The plant has a 100 tonnes per hour semi-portable crushing/screening unit where the rock is crushed to 50 - 6 millimetres (2" - 1/4") size. The crushed rock is stored in a covered shed from which it is fed into bucket elevators then to a surge bin. From the surge bin, the rock is fed into a weigh hopper where a specified weight is measured. This "charge" is fed via tripper belts into one of eight reactors. The entire charging system is automatic and is programmed from the control room.

One of the properties of rock, in our cold climate, is that while it is coarse (150 - 12 millimetres), it does not freeze into a solid mass when rain or snow falls on a pile and freezing occurs inside the pile. When the rock is crushed to 50 - 6 millimetres, the pile would freeze solid under the same conditions. The two month stockpile is left uncovered, while the crushed product is stored in a covered shed.

The semi-portable crushing/screening unit was purchased with over capacity for the future expansion. When expansion is complete, we expect the rock will come by rail and the crushing plant will be located at the railhead in British Columbia.

The magnesite rock contains approximately 28 per cent magnesium ion. The plant recovers about 78 per cent of the magnesium as saleable metal. About 11 per cent is crushing losses and the other 11 per cent is process losses.

The operating processes at the MAGCAN plant consists of three major parts:

1. The reactors which convert $MgCO_3$ to $MgCl_2$.
2. The electrolytic cells which convert the $MgCl_2$ to Cl_2 gas and magnesium metal.
3. The gas cleaning and waste disposal systems.

The reactor conversion process is based on a patent

Magnesium Company of Canada, Ltd., Calgary, Alberta

developed by the MPLC Laboratory Ltd. in the United Kingdom.

Magnesite rock is fed into the top of the reactor through a double bell system. Hot gas coming up from the "reaction zone" calcines the $MgCO_3$ to $MgO + CO_2$. This removes heat from the gas stream. The MgO particles work down in the reactor. Cl_2 and CO gas are put in below the MgO and the following reaction takes place:



This is a very exothermic reaction and the temperature is maintained at 1000 to 1200°C by controlling the feed rate of the Cl_2 and CO gases. Too high a temperature can cause the $MgCl_2$ to vaporize and cause dust losses through the offgas system. The molten $MgCl_2$ runs down to the bottom of the reactor.

The bottom of the reactor is filled with loose-packed carbon chunks. AC current is run through the carbon chunks to keep them hot (800°C). $MgCl_2$ freezes at 718°C. The molten $MgCl_2$ builds in the voids in the carbon zone and is tapped out at regular intervals into a ladle car. The ladle car transfers the molten salt to the surge furnace.

The molten $MgCl_2$ is stored in an electrically heated surge "furnace". The molten $MgCl_2$ is then transferred via vacuum ladle to one of the twenty D.C. electrolytic cells. The electrolytic cells are connected in series. The bus bar can carry up to 188 000 amps. In addition to $MgCl_2$, the cells are fed $CaCl_2$, $NaCl$ and KCl . These salts improve the performance of the cell and lower the melting temperature of the salt mixture. The $MgCl_2$ is decomposed into magnesium metal (liquid) on the steel cathode and chlorine gas at graphite anode by the D.C. current. The cell operates at 700°C and since magnesium metal freezes at 651°C, the magnesium stays molten and, because it is less dense than the salt mixture, it floats on the molten salt surface. The chlorine gas is taken off the back of the cell and recycled to the reactors. The magnesium is vacuumed (like oil skimming) off the top of the molten salt and taken to the refinery.

At the refinery, the metal is put into gas-heated steel pots (2 700 kilogram capacity), where the solid and liquid impurities settle out. It is then cast into ingots under a CO_2 plus 0.5 per cent SF_6 atmosphere (to prevent oxidation of the molten magnesium).

If a magnesium alloy is desired, the alloying materials are added to the molten magnesium in the refinery and the alloy is then cast into ingots.

The plant has a carbon monoxide generator where oxygen is blown into a coke bed at a controlled rate and CO_2 is added as a modulator. The temperature is maintained at about 1200°C so the second reaction can go to completion.

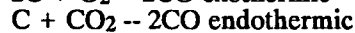

Make-up Cl_2 is purchased in RR tank cars and the liquid Cl_2 is vapourized in a Cl_2 vapourization plant.

Waste gases containing Cl_2 and HCl are scrubbed with NaOH solution in various packed towers. The hypochlorite generated is decomposed in a hypochlorite destruction system.



Various fumes and dusts are collected and scrubbed in a water scrubber system.

The scrubbed gases are manifolded to a single stack (50 metres high) which is monitored for Cl_2 and CO .

The electrolytic cells produce "waste" salts which are frozen before handling. Also, any waste material containing soluble salts is collected. The treated solutions from the various scrubbers are used to dissolve the soluble portion of the waste material, the inerts are filtered out and washed clean, then sent to landfill. All salt contaminated solutions are combined and put down a 2300 metres deep injection well.

All runoff water from the plant site is collected in a storm water runoff pond and it is pumped back to the plant as scrubber makeup water. Our environmental permit allows no water to leave the site. The Highwood River, a major trout stream, flows through the plant site and its protection is of prime concern.

This is a very brief simplified description of the plant processes. There are a great many details which are not covered in this paper.

SITE SELECTION

A few comments on the site selection process. We looked at sites from Squamish, B.C. on the Pacific Ocean to Quebec City on the Atlantic. While economics are critical to the final selection, the following items were a necessity for the site:

1. Railroad Service: We must get delivery of Cl_2 in RR tank cars. All other items could be trucked in or out.

2. A Source of Process Water: We need 30 cubic metres per hour of water for the first module and 150 cubic metres per hour for the final plant size. At High River we use tertiary treated sewage from the Town. We built a tertiary water treatment plant for this purpose and gave it to the Town. Also, we built a 3 mile pipeline from the treatment plant to our site. We do not use water from the Highwood River, which flows through the plant site.

3. Electric Power: We use 18 000 kilowatts per hour of electricity for the first module. The site needed to be near an existing power line. Environmental problems usually cause a delay of 5 years or more in building new long distance lines. Our power requirements will grow to about 100 000 kilowatts per hour, but we could not afford the time to build new lines as we add to the plant.

4. Waste Water Disposal: Since we produce various chloride salts (about 25 tonne per day) as part of our waste material, we need to dispose of them. The accepted method is to put the salts into a solution which can be put into the ocean or injected into an underground formation. At the plant we inject into the Elkton Formation (Mississippian) 2

300 metres deep. High River is as close to Calgary as you can get and still have a good injection formation available. The total cost of the injection well was about \$1 500 000 Canadian.

5. Plant Personnel: The first phase employs 140 people, mainly on shiftwork. There has to be a fairly large labour pool available to get qualified personnel. The Calgary area is our major labour source.

6. Local Acceptance: The community and local governments need to accept a heavy industrial plant handling various chemicals, etc. In looking at the various sites I would estimate about half said they would object to our locating in their area.

7. Freight Costs: This has an impact on the location. The cost of shipping the rock to the plant site, plus shipping chlorine, coke, and caustic to the site, and cost of shipping the metal to the market had to be considered.

RAW MATERIALS FOR MAGNESIUM METAL

Magnesium is the sixth commonest element in the earth's crust. Of it is not present as the free metal.

Sea water which contains 0.13 per cent Mg ion in the form of MgCl_2 . Lime (CaO) or Dolomitic Lime (CaO.MgO) is used to precipitate Mg(OH)_2 . This process is rather common. Dow uses it at their Freeport, Texas plant; Norsk Hydro uses it in Norway for one of their processes; and a large number of refractory companies use it as a step in making MgO for refractory purposes.

Brines containing MgCl_2 are evaporated to make a concentrated MgCl_2 solution. American Magnesium Co. in Snyder, Texas used a 11 per cent MgCl_2 brine from the Yates formation as a source of material and concentrated it to 25 per cent in their solar ponds. The Magnesium Corporation of America at the Great Salt Lake uses solar ponds to concentrate the lake water (1.6% MgCl_2) to 30 per cent MgCl_2 . They also used bitterns from Leslie Salt sea water solar ponds in San Francisco Bay when the MAGCOR solar ponds were flooded in the early 1980's. Norsk Hydro in Norway in a second process also uses brine (35% MgCl_2) which is a by-product of the German potash industry. Dow's original magnesium plant in Michigan used an underground brine as its source. Now that brine is used to make CaCl_2 and MgO .

Dolomite is used as a source of magnesium by the direct reduction of the MgO content by silicon (ferrosilicon).

Magnesite (MgCO_3) is used by MAGCAN as noted above. Norsk Hydro in Quebec uses magnesite from China and dissolves it in HCl solution to make a MgCl_2 brine. The Basic Magnesium Plant at Henderson, Nevada, which operated during the Second World War, used magnesite and brucite from Gabbs, Nevada.

The Noranda Company is presently developing a process to make magnesium from MgCl_2 which will be made from the tailings from the Quebec asbestos mines.

The TVA before the Second World War tried to

develop processes to make magnesium from olivine ($\text{Mg, Fe}_2\text{SiO}_4$).

The Soviets mine carnallite $\text{KMgCl}_3 \cdot 6\text{HO}$ and use the MgCl_2 portion to make magnesium with potash (KCl) as a by-product.

As you see, there are a variety of sources for magnesium metal. They all suffer from the same problem - they contain impurities which adversely affect the quality of the produced metal.

Prime magnesium - ASTM 9980A quality has the following limits on impurities:

Copper	0.02%
Lead	0.01%
Manganese	0.10%
Nickel	0.001%
Tin	0.01%
Other impurities each	maximum 0.05%
Magnesium by difference	minimum 99.80%

(The total of all impurities cannot exceed 0.20%.)

The major reason for keeping the impurities low in the primary metal is that they accelerate the corrosion of magnesium. Any H_2O present on a magnesium metal surface will start a corrosion reaction at an impurity grain. Coated magnesium does not corrode if H_2O does not get to the metal surface. The processing of the raw material is how most of the impurities are removed. In addition, boron compounds and sulfate ions have a very adverse affect on the electrolytic process so they need to be removed also.

At the present time magnesium is made by one of two processes:

- (1) Reduction of MgO by silicon (in ferrosilicon).
- (2) Fused salt electrolysis of MgCl_2 .

There are a number of other processes which have been tried and have not succeeded, primarily for economic reasons.

- (1) Reduction of MgO by carbon - the Hansgirg process.
 $\text{MgO} + \text{C} = \text{Mg} + \text{CO}$ (very reversible)
- (2) Reduction of MgO by another metal. Aluminum and sodium have been tried. The Intal process used aluminum.
 $3\text{MgO} + 2\text{Al} - 3\text{Mg} + \text{Al}_2\text{O}_3$
- (3) Reduction of MgO by CaC_2 - the Murex process.
 $3\text{MgO} + \text{CaC}_2 - 3\text{Mg} + \text{CaO} + \text{CO}$
- (4) Electrolytic "reduction" of MgO in a fluoride salt bath. This reaction appears similar to the Hall aluminum cell but MgO is not soluble in MgF_2 - the American Magnesium Corp process (1920s).
 $\text{MgO}(\text{s}) + \text{C} + \text{F}_2(\text{g}) - \text{MgF}_2(\text{l}) + \text{CO}$
 $\text{MgF}_2(\text{l}) - \text{Mg}(\text{l}) + \text{F}_2(\text{g})$

Depending on economics and process equipment improvements, some of these processes may be revived.

REDUCTION OF MgO BY SILICON

The cheapest source of silicon is ferrosilicon made in electric arc furnaces.

The reaction is:

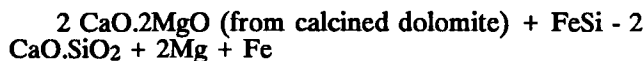

Heat is applied to make the reaction go and a vacuum is pulled on the system to vaporize the magnesium. The magnesium vapor is condensed to a solid in a vessel outside the reaction vessel. The iron does not enter into the reaction. The $2\text{CaO} \cdot \text{SiO}_2$ is a "slag".

The Pidgeon version uses a small retort and it is a batch process using pellets and the "slag" never becomes molten. The Timminco Plant in Ontario uses this process. There are a number of small plants around the world which use variations of this process.

The Magnetherm (Pechinay) version uses large retorts and is semi-continuous, the slag is molten due to the addition of Al_2O_3 as a flux agent, and the slag is tapped from the retort. Northwest Alloys (ALCOA) in Washington State uses this process in addition to the original plant in France and a third plant in Yugoslavia.

FUSED SALT ELECTROLYSIS OF MgCl_2

About 90 per cent of the magnesium produced today is made by fused salt electrolysis; there are two variations of the process.

(1) The Dow process which uses a dry feed of $\text{MgCl}_2 \cdot \text{H}_2\text{O}$. Graphite anodes are consumed to remove the oxygen.

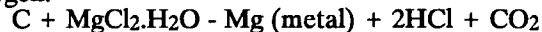

The HCl is used to dissolve the $\text{Mg}(\text{OH})_2$ precipitated from sea water. The resultant MgCl_2 brine is purified before being dried in spray driers.

(2) Anhydrous MgCl_2 feed. The feed can be dry or molten. The new Norsk Hydro process concentrates 35 per cent MgCl_2 brine to 80 per cent MgCl_2 . The hot 80 per cent solution is prilled to a solid in a tower then an HCl fluid bed drier removes the last H_2O from the MgCl_2 prills.

The anhydrous prills are fed directed into electrolytic cells.

Most plants use molten MgCl_2 as the feed. There are a number of ways of obtaining the molten feed.

a. From a Faben chlorinator: MgO and coke are pelletized and hot Cl_2 blown through the pellets.

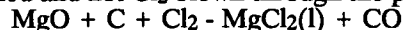

b. From the MAGCAN reactor:

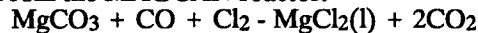

c. From melting spray dried powder:

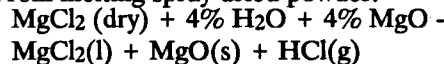

The MgO sludge is settled out in the melt furnace.

d. From melting carnallite:

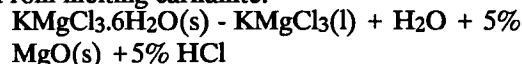

The MgO sludge is also settled out.

e. From molten MgCl_2 from a Kroll titanium reactor.
 $2\text{Mg} + \text{TiCl}_4 - \text{MgCl}_2(\text{l}) + \text{Ti}(\text{s})$

This has been a brief overview of magnesium metal raw materials sources and production methods. There are a great many details and problems which have been omitted. The magnesium industry consists of a number of small plants (compared to other metals), each with its

own proprietary process. No one process has developed as a standard method as has occurred in the aluminum industry.

REFERENCES

- Emley, E.F. (1966): Principles of Magnesium Technology; Pergamon, London.
- Gross, W.H. (1949): The Story of Magnesium; *American Society for Metals*, pages 1-258.
- Magnesium Production Facility, Socio-economic and Environmental Impact Assessment, 1986; *Magnesium Company of Canada Ltd.*, Lavalin, Calgary, Alberta.
- Mamantou, G. (1987): Advances in Molten Salt Chemistry; in *The Chemistry and Electro-chemistry of Magnesium Production*, Kipouros, G.J. and Sadoway, D.R., Editors, *Elsevier*, Amsterdam, Volume 6, pages 127-209.
- Pidgeon, L.M. (1946): Magnesium; *American Society for Metals*, Cleveland, Ohio, pages 1-22.
- Shackleton, C.E.E. et al (1981): U.S. Patent No. 4,269,816.
- Strelets, Kh.L. (1972): Electrolytic Production of Magnesium; *Metallurgiya*, Moscow, translated by J. Schmorak, Keter, Jerusalem, 1977, also available as TT 76-50003, *U.S. Department of Commerce*, NTIS, Springfield, VA.

BARITE AND ITS USES AS A FILLER AND EXTENDER

By Ronald J. Singh

Mountain Minerals Co. Ltd., Lethbridge, Alberta

INTRODUCTION

Industrial minerals historically were seen as high bulk/low-value commodities that were dug out of the ground and processed with very little value added.

The term "filler and extender" encompasses a range of particles used to increase the bulk and modify the performance properties of several products. Some examples of the range of applications of typical mineral fillers have been compiled in Table 1. The current widespread use of fillers throughout the industry is based traditionally on two important advantages that they bring to the economics and performance of materials:

The inclusion of fillers or extenders in product formulations reduces the demand for expensive matrix components such as resins in plastics, solvents and extender pigments in coatings, elastomers in rubbers and bitumen in asphalts; this reduced demand for raw materials improves the cost-effectiveness of the product in the marketplace provided the filler is of low cost relative to the replaced components.

By careful selection of appropriate filler(s), the engineering properties of a raw material matrix may be modified, which may in turn enhance the final product.

CHARACTERISTICS OF A FILLER

In general, a user will select fillers on the basis of their ability to modify one or more of the following characteristics in the end product:

- Cost (lower)
- Physical properties
- Flow
- Density
- Particle size distribution
- Colour or Brightness
- Hardness, brittleness and strength
- Fire resistance
- Heat or electrical conductivity

Modification of such properties is rarely attained without the introduction of some adverse effects. Fillers added to reduce the cost of plastics may make them more brittle, and paints may show poor storage properties or optical characteristics. The selection of suitable fillers or combinations of fillers will depend on both economic and technical factors, and to a large degree on the influences of "tradition" in the user industries. From the technical perspective, fillers are judged by their properties and characteristics, some of which are inherent to the material from which they are derived; others are a consequence of the manner in which they are processed (size).

Inherent properties of filler minerals are such natural characteristics as hardness, natural particle size and shape, refractive index, chemical reactivity and chemical composition.

Properties that result from processing of mineral fillers are characteristics such as particle size distribution, colour and particle shape.

The most important characteristic of any filler is its particle size distribution. In general, quality and the distribution of particle size will govern use and price for most fillers. In some applications, the maximum quantity of fines must be controlled; in others, coarse particles are unacceptable. In some applications, a distribution of particle sizes that favours efficient packing is desirable to reduce void space or binder demand. Appearance, manifested as brightness or whiteness, is influenced by particle size as are oil absorption, wettability and the influence of fillers on the mechanical properties of filled films or polymer composites.

The selection of a filler for a particular application is also very much influenced by the particle shape.

TABLE 1
MINERAL FILLERS USED BY VARIOUS INDUSTRIES

USE/APPLICATION	FILLER
Asbestos - Cement Products	Calcium carbonate, mica, mineral wool
Asphalt Products	Calcium carbonate, talc, pyrophyllite, mica, asbestos, Portland cement
Brake Lining	Mineral wool, barite, calcium carbonate, silica
Bricks, Concretes, Mortars	Calcium carbonate, fly ash, diatomite, pumicite
Caulking and Sealing Compounds	Calcium carbonate, kaolin, talc, asbestos, silica, barite
Drilling Muds	Bentonite, barite, mica, perlite
Fertilizers and Soil Conditioners	Kaolin, diatomite, bentonite, perlite, vermiculite, silica
Floor Tiles, Linoleum and Carpet Backing	Calcium carbonate, asbestos, talc, kaolin, bauxite, barite
Foam	Calcium Carbonate, barite
Insecticides and Pesticides	Fuller's earth, calcium carbonate, talc, pyrophyllite, bentonite, kaolin, diatomite
Ink	Kaolin, barite, carbon black
Putty	Calcium carbonate, kaolin, talc, asbestos, silica, barite
Paper	Kaolin, calcium carbonate, talc
Paint	Calcium carbonate, asbestos, mica, kaolin, barite, talc, pyrophyllite, nepheline syenite, diatomite, silica
Plastics	Calcium carbonate, asbestos, mica, barite, kaolin, talc, pyrophyllite, nepheline syenite, diatomite, silica, wolastonite
Rubber	Calcium carbonate, kaolin, precipitated silica, talc, mica, barite, carbon black
Rust Proofing	Barite, calcium carbonate, silica, kaolin
Sound Deadening	Barite, carbon black, calcium carbonate

Because most fillers are produced by crushing, grinding and classifying minerals, they are usually of an irregular particle shape. Synthetic fillers are likely to be more regular in shape, and are either fibrous or generally spherical in form.

Where colour is important in the end product, the colour of the filler is a critical factor in its acceptability. Paper, foam and paint applications are particularly influenced by filler colour. The colour of a filler may sometimes be modified by removal of a coloured component (for example, an iron compound) during processing.

Refractive index is closely related to colour in that it strongly influences the appearance of the final product. The difference between the refractive index of the filler and the binder determines the extent of light scattering and hence, opacity and "whiteness" that the filler imparts to the filled product.

Chemical composition is important for some applications where the filler might be susceptible to attack when the end product is in service, or where chemical reactivity of the filler may influence the processing or integrity of the matrix material. As with colour, some modification of chemical composition may be possible during processing. Deliberate modification of chemical properties may be induced by acid washing, calcining or treatment with surface-active molecules or coupling agents.

With such a range of parameters, filler selection inevitably involves some compromises which the chemist must balance against the performance and cost-effectiveness of the product.

BARITE AS A FILLER

Barite is a common mineral found extensively around the world. It is frequently found as a replacement orebody in limestones or dolomites and is typically found in veins or as residual deposits in highly weathered rocks.

Mineral Name:	Barite
Chemical Names:	Barium Sulphate, Barium Sulfate
Chemical Formula:	BaSO ₄
Barite Properties:	Pure BaSO ₄ (100%) Specific Gravity: 4.48 MOHS Hardness: 3.5 - 4 Refractive Index: 1.64 (Average) Insoluble in concentrated acids. Fuses at 800°C to 1100°C to form Sulphide or Carbonate of Barium.

Pure barite is white, but crystalline varieties may have a translucent blue, pink, grey or green hue. All are white when ground into powders. The colours of industrial grade barite are typically:

Buff Tan
Pink
Brown
Yellow Brown
Grey
White

These colours are typical of the impurities associated with barite deposits, for example:

Colour	Typical Impurity
Buff Tan	Iron Hydroxides (Limonite)
Pink	Iron Oxide (Hematite)
Brown	Iron Oxides and Clays
Yellow Brown	Iron Oxides and Hydroxides
Grey	Shales and Clays
White	Typically low impurities except for Quartz and Calcite

Many types of barite ore are used to produce industrial grade barite in North America.

Virtually all barite ores have some impurities resulting in varying properties such as:

Colour
Specific Gravity
Chemical Composition

The most important impurities are:

Silica and Silicates
Iron Oxides and Hydroxides
Lead and Heavy Metals

IMPORTANT PROPERTIES OF BARITE AS A FILLER

SPECIFIC GRAVITY

Pure barite (100% BaSO₄) has a specific gravity of 4.48. Most industrial grade barite has a specific gravity ranging from 4.2 to 4.3 with some very pure products falling in the range of 4.3 to 4.4 or greater.

Essentially, specific gravity is related to chemical purity. Since most impurities such as silica, calcite, iron hydroxides and clays have lower specific gravity than barite, the combined effect lowers the specific gravity of the final product.

FREE SILICA CONTENT

With the recent awareness of silica hazards and the resulting governmental and industrial awareness programs, silica content can be an important impurity.

Silica can occur in combination with many elements, most form minerals of the silicate class. The most common type of silica is silicon dioxide (SiO₂). In natural form this is quartz.

Many other minerals share the same chemical formula but have different properties and crystal structures. Most forms of SiO₂ are hazardous in terms of respirable silica.

Barite ores are normally analyzed for silica content. Most analysis is to determine total silica content.

Free silica content is defined as unbound grains of silica which can be separated from other grains by selective gravity separation. By this method only free unbound grains with a specific gravity lower than 2.9 (quartz) are separated; most other forms of silica have specific gravities at about 2.65.

In most cases free silica content is one or two orders of magnitude lower than total silica content, since in many barite ores the silicates are bound to or locked within individual grains of barite. Furthermore, free silica in the ground-barite products usually occurs as

coarser sand-sized particles since silica is much harder and more abrasive than barite.

Hazardous, respirable silica is particulate silica below 10 microns at concentrations above 0.1 per cent by weight in the product which can be freely respirated.

Finally, silica is important due to its abrasiveness. Barite containing excessive amounts of quartz, for example, can cause excessive abrasion to mixing and shearing equipment. However, only the free silica can abrade equipment. It should also be noted that the particle size of the barite has the largest impact on abrasiveness. Basically, the coarser the grind the more abrasive it will be.

OIL ABSORPTION

Oil absorption is a property important to paint formulators, rubber compounding and plastics companies. It often determines the amount of resin, binder or solvent required in a particular formula.

Essentially oil absorption is a function of surface area. Surface area is in turn a function of particle size and shape. As a general rule of thumb, the finer the particle distribution the higher the oil absorption will be. However, other factors may also affect oil absorption. Oil absorption by barite is low in comparison to the minerals which are generally euhedral (regular). It is also influenced by the surface properties of barite which are more inert than of calcium carbonate for instance.

Oil absorption is adversely affected by the presence of clay minerals or hydroxides of iron as impurities in the barite. These impurities have extremely high specific surface areas and even in minor amounts can cause higher than normal oil absorption.

HEGMAN FINENESS

Hegman Fineness is a measurement of the cleanliness of a grind and refers to the occurrence of coarse grains or the largest grains present in the grind. Hegman Fineness (as liquid suspension) is widely used in the paint industry.

PH VALUE

This property is important because most liquid systems (where barite is used as a functional filler or pigment extender) will be influenced by acidic or basic chemicals. Undesirable effects from poor pH balance in paint systems are:

- Seeding
- Flocculation
- Agglomeration
- Cross Linking

The pH of powders dissolved in aqueous solvents depends on the presence of acids or alkalis in the powder. Since barite is insoluble even in strong acids, it is unlikely that it contributes to pH. However, other mineral substances can contribute to pH.

Barite which is jigged, floated and dry milled remains for the majority of cases neutral (pH = 7). Some barite concentrates can be slightly alkaline (pH 7.5 to 8) due to the presence of hydroxides of:

- Calcium

Magnesium
Iron

The hydroxides in barite are products of the calcining of calcium carbonate, dolomite or limonite impurities.

Bleached barites are acidic due to the residual chemicals left over after the bleaching process. These barites tend to be less than pH 5. For instance, Pfizer barite is pH 4. This is a distinct disadvantage since paint formulators must compensate for the acidity of the barite by buffering.

The most desirable pH is neutral since no adjustment is required to balance the pH.

DRY BRIGHTNESS

Dry brightness is a widely used term to describe the whiteness of powders. It is important to know what method is used to arrive at a dry brightness value.

The term "dry brightness" originated from the limestone industry to describe the whiteness of slaked limestone.

PRODUCT CLASSIFICATION

Barite products are used in an extremely wide range of industrial end uses. The primary function of barite as a filler-extender is to provide:

- Density
- Physical volume
- Chemical inertness
- Heat absorption
- Sound absorption
- Low oil absorption
- Opacity
- Whiteness
- Hiding power

There are approximately ten distinct end-use applications:

- Sound deadening (Automotive)
- Brake linings and friction materials (Automotive)
- Urethane foams (foam rubber)
- Rubber
- Paints and coatings
- Copper refining
- Explosives
- Glass making
- Putty, caulks and sealants, including Adhesives
- Specialty papermaking

Coarse Grade Barite - typically minus 200 mesh to minus 325 mesh. This barite is used in applications such as sound deadening, brake linings, foam rubber, rubber, copper refining, explosives, glassmaking, putty, caulks and sealants.

Micronized Grade Barite - typically minus 20 micron products. This micronized barite is used in applications such as: paints and coatings, rubber, putty, caulks, sealants and adhesives, and specialty papermaking.

Coarse grade barite tends to be used in large volumes relative to micronized barite. However, coarse barite tends to be priced two to four times less than the micronized products.

VARIOUS BARITE ORES FOUND ACROSS THE WORLD

HIDING POWER OF PIGMENTS

The ability of paint to hide the colours beneath is dependant largely on the number and size of pigment particles per unit area and on their light absorbing and light scattering capacity.

If a paint layer has no pigment particles in it, it's hiding power depends on the absorption and scattering of light by the vehicle. But if the layer has many particles per unit area, each layer will have considerable hiding power. For light coloured layers the pigments must have a high capacity to scatter light. Since the light scattering property of pigments depends on the ratio, pigment to vehicle of refractive index, it is important to have pigments with indices of refraction as different as possible from the vehicle. Pigments with indices of refraction not much different from those of usual vehicles (such as silica pigment in linseed oil) makes paints with little hiding power.

Generally what this boils down to is: THE HIGHER THE REFRACTIVE INDEX A PIGMENT HAS, THE BETTER IT'S HIDING POWER.

Here is a list of some common pigments along with their indexes of refraction:

PIGMENT	INDEX OF REFRACTION	HIDING POWER
Silica	1.55	Poor
Calcium Sulfate	1.59	Poor
Barium Sulfate	1.64	Fair
Lithopone	1.84	Fair
Basic Sulfate White Lead	1.93	Good
Basic Carbonate White Lead	1.94-2.09	Good
Zinc Oxide	2.02	Good
Antimony Oxide	2.09-2.29	Good
Zinc Sulfide	2.37	Very Good
Titanium Oxide (anatase)	2.55	Excellent
Titanium Oxide (rutile)	2.76	Excellent

SOME PROPERTIES OF VARIOUS PIGMENTS

	Density	Refractive Index	Oil Absorption
Calcium Carbonate	2.7	1.6	6 - 24 ML/100g
Talc	2.7	1.55	30 - 50 ML/100g
Barite	4.5	1.64	8 - 15 ML/100g
Kaolin	2.58	1.56	30 - 60 ML/100g
Silica	2.65	1.55	13 - 35 ML/100g
Mica	2.82	1.58	50 - 80 ML/100g
Asbestos	2.5	1.52	
Wollastanite	2.4	1.63	25 - 30 ML/100g

Country	Region	Typical Colour	Impurities
U.S.A.	Georgia	Yellow-Brown or Buff-Tan	Iron Hydroxides, Iron Oxides, Lead, Quartz and/or Silica
	Missouri	Pink or Light Brown	Hematite, Iron, Oxides & Hydroxides, Lead, Quartz and/or Silica
	Nevada	Grey	Shale, Clays, Dolomite, Chert, Quartz and/or Silica
	Montana	White or Greyish White	Relatively pure except for Quartz and/or Silica and Calcite
	Alaska	Grey	Clays, Shale, Dolomite, Quartz and Silica
	China	Zhejiang	Grey or Greyish White
Hubei		Buff-Tan	Iron Hydroxides, Strontium Sulfate, Quartz and/or Silica
Guangxi		White	Relatively pure Strontium Sulfate, Quartz and/or Silica
Mexico		Nereva Leon NE	Buff-Tan Light Pink
	Muz Quiz	White	Pure except for Calcite, Silica and Quartz
	Nereva Leon NW	Greyish Black	Shale, Clay, Dolomite, Calcite, Quartz and Silica
Algeria	Coahuila	White	Relatively pure except for Strontium Sulfate, Quartz and/or Silica
		White	Relatively pure except for Strontium Sulfate, Quartz and/or Silica
		White	Relatively pure except for Strontium Sulfate, Quartz and/or Silica
Canada	Ontario	Pink	Iron Oxide (Hematite), Calcite, Quartz and/or Silica
	Yukon	White	Pure except for Quartz, Silica and Calcite
Ireland	British Columbia	White	Relatively pure except for Quartz and/or Silica and Calcite
	Tipperary County	Greyish White or Greyish	Shale, Clays, Dolomite, Black Chert, Quartz and/or Silica
Morocco		White or Greyish White	Relatively pure except for Strontium Sulfate, Quartz and/or Silica
India	Andhra Pradesh	Yellow-Brown Buff-Tan	Iron Hydroxides, Iron Oxides, Lead, Quartz and/or Silica
U.K.	Clydesdale District	White	Relatively pure except for Quartz and/or Silica and Calcite

THE NORTH AMERICAN MARKET FOR BARITE

This market can be divided into two distinct market segments:

- (a) Coarse grind markets
- (b) Micronized grind markets

It is estimated that approximately 150 000 short tons of barite are sold per year as a filler and extender in the North American market. This market is made up of 65 per cent coarse grade and 35 per cent micronized grade products.

There are approximately 18 companies in North America producing barite from either domestic sources or imported barite ore. Most of the imported ore comes from China, Algeria, Mexico and Morocco. In addition, there are three known imported barite products which are used in North America. These are mainly high quality micronized products which are not usually readily available in North America.

Most producers of barite for the filler market usually restrict the range of products they produce to some specified segments and only a very few sell a complete range of products.

This barite filler and extender market is extremely competitive and freight rates play an important part as to whether or not a supplier can sell its product in a specific market segment.

BIBLIOGRAPHY

- Adhesive Handbook; Editor, Shields, J., Third Edition.
- Collings, R.K., Mineral Waste as Potential Mineral Fillers, Proceedings ORF/CANMET Symposium on Mineral Fillers, Toronto, October 20-21, 1981.
- Eckert, C.H., The Increasing Impact of Canadian Industrial Minerals on the North American Filler and Extender Market; Paper presented at the Sixth Industrial Minerals International Congress, Toronto, May 21-24, 1984.
- Eckert, C.H., Extender and Filler Pigments Versus Other Industrial Minerals - What it Takes to Succeed; Paper presented at the Metal Bulletin Pigments and Extender Forum, Atlanta, November 30, 1984.
- Ferrigno, T.H. (1978): Principles of Filler Selection and Use; Editors, Katz, H.S. and Milewski, J.V., Handbook of Fillers and Reinforcements for Plastics, *Van Nostrand and Reinhold*, New York.
- Katz, H.S. and Ehrenreich, L., (1978): Glass Fillers; in Additives for Plastics, Editor, Seymour, R.B., *Academic Press*, Vol. 2.
- Lefond S.J., Industrial Minerals and Rocks, Vol. I, Barium Minerals.
- Milewski, J.V. (1978): Packing Concepts in the Utilization of Filler and Reinforcement Combinations; Handbook of Fillers and Reinforcements for Plastics, Editors, Katz, H.S. and Milewski, J.V., *Van Nostrand and Reinhold*, New York, .
- Muck, D.L. and Ritter, J., Glass Microspheres: Bubbles and Beads as Plastics Additives; *Plastics Compounding* Jan/Feb, 1979, pages 12-28.
- Oleesky, S.S. and Mohr, J.G. (1964): SPI Handbook of Reinforced Plastics; *Reinhold*.
- Ritter, J. (1970): Sphere-filled Plastic Composites Theory, Testing, Applications; Paper at the 25th Anniversary Technical Conference RP/CI, SPI, Section 8-A.
- Ryan B. and Tardy, B. (1978): Solid Spherical Fillers and Hollow Spherical Fillers, Handbook of Fillers and Reinforcements for Plastics, Editors, Katz, H.S. and Milewski, J.V., *Van Nostrand and Reinhold*, New York.
- Saveringhaus, N. (1975): Fillers, Filters and Absorbents; in Industrial Minerals and Rocks, Ed. in Chief, S. J. Lefond, *American Institute of Mining Metallurgy & Petroleum Engineers Inc.*, New York.
- Surface Coating Vol. 1 and 2, Raw Material and Their Usage, Prepared by the *Oil and Colour Chemist's Assoc.*, Australia.

GEOLOGY OF TALC AND CHLORITE DEPOSITS IN MONTANA

By Richard B. Berg

Montana Bureau of Mines and Geology, Butte, Montana

ABSTRACT

Since 1976 talc production from Montana deposits has more than doubled to an estimated 412 000 tonnes in 1989. Two open-pit mines in the Gravelly Range and an underground mine and open-pit mine in the Ruby Range account for present production. Chlorite is mined from an open-pit mine in the Highland Mountains. Crude as well as processed talc are supplied to both domestic and foreign markets. These markets include paper, paint, plastics, rubber, ceramic products and cosmetics. All talc deposits mined in Montana occur in dolomitic marble in

the Archean Wyoming province. Talc occurrences range from microscopic disseminated grains to a massive talc body 50 metres thick. Replacement bodies of talc formed after the peak of metamorphism, 2 750 Ma ago, as shown by the associated alteration of sillimanite, forsterite and tremolite to phyllosilicates. Most talc formed by the reaction $3 \text{ dolomite} + 4 \text{ SiO}_2 + \text{H}_2\text{O} = \text{talc} + 3 \text{ calcite} + 3 \text{ CO}_2$. Absence of talc deposits in dolomitic units in Paleozoic sedimentary rocks of southwestern Montana implies a Precambrian age. Chloritic alteration of Archean quartzofeldspathic gneiss and Proterozoic metasedimentary rocks in the Highland Mountains, 60 kilometres northwest of the major known talc deposits, indicates introduction of magnesium into these Precambrian rocks, probably at the same time and under the same conditions as for talc formation.

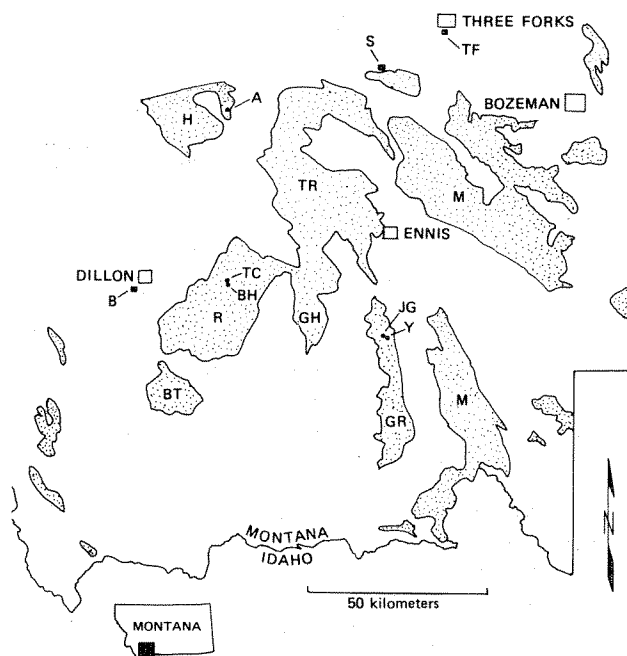

Figure 1. Talc and chlorite mines (●) and mills (○). Stippled pattern indicates Archean metamorphic rocks (modified slightly from Bergantino and Clark, 1985). H = Highland Mountains, TR = Tobacco Root Mountains, R = Ruby Range, BT = Blacktail Range, GH = Greenhorn Range, GR = Gravelly Range, M = Madison Range, HL = Henry Lake Mountains.

INTRODUCTION

Montana is a leading talc producing state with three companies mining talc at three open-pit mines and one underground mine. The related mineral chlorite is mined from one deposit. All of these deposits occur in Archean metamorphic rocks exposed in basement-cored foreland uplifts in the southwestern part of the state (Figure 1). The presence of large talc deposits that are of high purity and in most instances can be recovered by surface mining, has contributed to the competitive position of talc from Montana. Cyprus Industrial Minerals Company mines talc from their large Yellowstone mine south of Ennis. Just to the west of this mine The Montana Talc Company's Johnny Gulch mine is a source of talc for their mill at Sappington. The Montana Talc Co. is a relative newcomer to the Montana talc industry with the start up of their mill in 1986. The underground Beaverhead mine in the Ruby Range east of Dillon is operated by Cyprus Industrial Minerals Company. Talc from both the Beaverhead and Yellowstone mines is trucked to a mill at Three Forks for processing. Just to the north of the Beaverhead mine, Pfizer, Inc. mines talc on Stone Creek at the Treasure mine (Figure 2). Talc ore from this mine is processed at the Barratts mill south of Dillon. Cyprus Industrial Minerals Company also mines chlorite from the Antler deposit in the Highland Mountains. This

Symbol	Mine or Mill	Commodity	Ownership
A	Antler mine	Chlorite	Cyprus Industrial Minerals
T	Treasure mine	Talc	Pfizer, Inc.
BH	Beaverhead mine	Talc	Cyprus Industrial Minerals
JG	Johnny Gulch mine	Talc	The Montana Talc Company
Y	Yellowstone mine	Talc	Cyprus Industrial Minerals
B	Barratts mill		Pfizer, Inc.
S	Sappington mill		The Montana Talc Company
TF	Three Forks mill		Cyprus Industrial Minerals

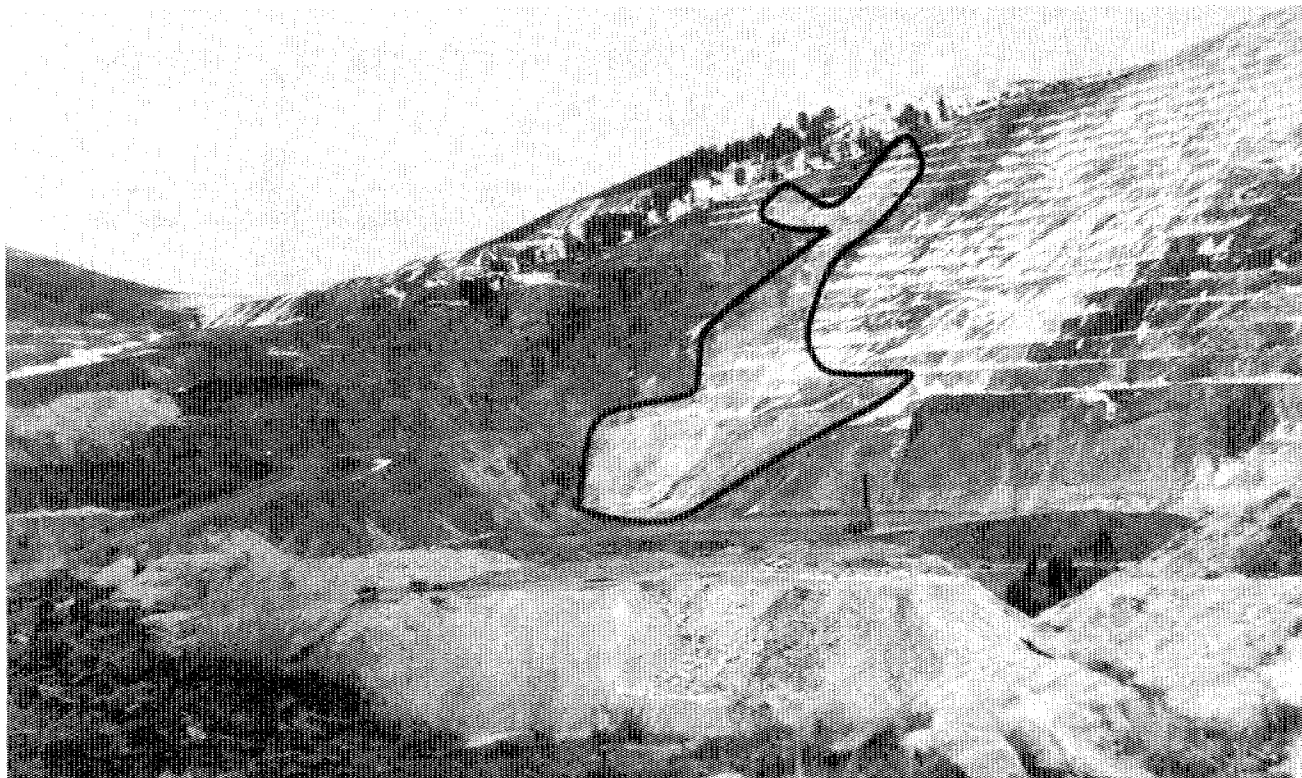

Figure 2. The Treasure mine in the Ruby Range, owned and operated by Pfizer, Inc. The lighter inclined body exposed in the cut (in outline) is the main talc body.

mineral, which is similar to talc, is used in some of the same applications.

Until recently, all talc produced from Montana mines was hand sorted to remove impurities before grinding. In 1987 Cyprus Industrial Minerals Company installed a mechanical sorting facility at their Yellowstone mine enabling them to lower production costs. Pfizer, Inc. completed construction in 1991 of a flotation mill at their Barratts plant. This mill will supplement hand sorting of talc ore and enable Pfizer to produce a high-purity product from lower quality ore.

Estimated 1989 Montana talc and chlorite production of 412 000 tonnes was valued at \$12 718 000 (U.S. Bureau of Mines, 1990). The average value of \$30.80 per tonne is for crude talc and chlorite; processed talc typically sells in the \$100 to 200 per tonne range. Montana became a major talc producer only recently. Total talc production from Montana deposits through 1956 was estimated to be approximately 200 000 tonnes and most of that was mined after 1949 (Chidester and others, 1964, p. 35). Talc production has generally increased after the 1950's to 311 000 tonnes in 1979 (Krempasky and others 1982, p. 318). This increase in production is directly related to an expansion in talc markets.

Total U.S. talc production also increased during this time from an average production of only 683 000 tonnes for the years 1954 to 1958 (Cooper, 1964, p. 1097) to 1.25 million tonnes in 1989 (Virta, 1990, p. 169). World talc and pyrophyllite production (mainly talc) in 1989 was 7.67 million tonnes (Virta, 1990, p. 169).

Talc supplied by Montana producers to domestic and foreign markets is used in paper, paint, plastics, ceramics, rubber and cosmetics. The use of talc in paper

manufacture for pitch control, has become an important market for talc from Montana in recent years. Markets served by talc from Montana are widespread. This commodity is exported to the Europe and Pacific Rim countries in addition to serving domestic markets.

There is a good possibility that new deposits of talc can be discovered in the state. In the last few years exploration for talc deposits has progressed from simply searching for talc fragments in the soil to using more sophisticated prospecting methods.

Mineralogical analysis of soil has been shown to be a useful method of talc exploration (Blount and Parkison, in press) and geologic studies have provided a better understanding of talc formation leading to more effective exploration (Anderson, Mogk and Childs, 1990).

TALC AND CHLORITE OCCURRENCES

GEOLOGIC SETTING

With one minor exception, all talc that has been mined in Montana is from deposits in Archean metamorphic rocks exposed in the southwestern part of the state. Archean metamorphic rocks of the Wyoming province (Condie, 1976) are exposed in the cores of uplifted fault blocks forming the mountain ranges of southwestern Montana (Figure 1). The cores of these ranges are flanked by Phanerozoic sedimentary rocks. Quartzofeldspathic gneiss, amphibolite, marble, quartzite and pelite are the major exposed Archean metamorphic rocks with quartzofeldspathic gneiss the most extensive. Amphibolite facies assemblages predominate with rare granulite facies and local retrograde alteration to greenschist assemblages. However in the southern

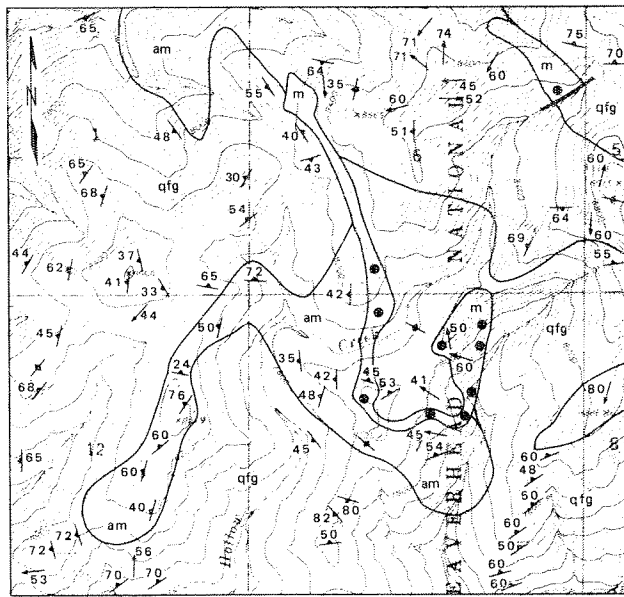

EXPLANATION

- | | | |
|-------------------------------|----|---------------------------------------|
| Archean metamorphic rocks | 56 | Bearing and plunge of lineation rocks |
| m Dolomitic marble | 70 | Strike and dip of foliation |
| am Amphibolitic | ↗ | Vertical foliation |
| qfg Quartzofeldspathic gneiss | ● | Talc occurrence |
| | — | Contact |
| | — | Fault |
- 1 kilometer

Topographic base from Ruby Dam 7½ minute quadrangle

Figure 3. Precambrian geology of a small area in the Greenhorn Range showing distribution of talc occurrences in dolomitic marble. Map includes parts of sections 1 and 12, T.8 S., R.4 W., and 5,6,7 and 8 of T.8 S., R.3 W. (from Berg, 1979a, Sheet 3).

part of the Madison Range, Henrys Lake Mountains and some areas within the Gravelly Range, only greenschist-facies rocks are exposed. Rb-Sr whole-rock dates from the Ruby Range and Tobacco Root Mountains indicate an age of metamorphism of 2 750 Ma, probably indicating the time of metamorphism to amphibolite grade (James and Hedge, 1980). Precambrian deformation of these rocks has been complex, including at least four generations of folds in the Ruby Range (Karasevich, 1980, and James, 1990). Pegmatite dikes and mafic dikes intruded the Archean metamorphic rocks after deformation.

The Hell Canyon pluton of the Boulder batholith (Late Cretaceous) intruded Precambrian metamorphic rocks in the Highland Mountains and the Tobacco Root batholith, also of Late Cretaceous age intruded the Precambrian core of the Tobacco Root Mountains. These are the only large post-metamorphic igneous bodies that have intruded the Archean metamorphic rocks exposed in the mountain ranges shown in Figure 1.

DEPOSITS

Within the Archean metamorphic rocks talc deposits are confined to dolomitic marble (Figure 3). In the west-

ern part of the Greenhorn Range approximately 11 per cent of the 105 square kilometres of exposed Archean rock is marble of which about two thirds is dolomitic (Berg, 1979b). In the Ruby Range marble accounts for an estimated 5 to 10 per cent of the exposed metamorphic rocks, and only about 2 per cent in the Tobacco Root Mountains (Pearson and others, 1990). In the Tobacco Root Mountains marble layers are most abundant in the southwestern part of the range (Vitaliano and Cordua, 1979).

Talc occurs in podiform masses, commonly elongate parallel to foliation and lithologic layering in the marble and in bodies that range from those with dimensions measured in tens of metres to disseminations that can only be recognized microscopically. The talc body exposed in 1973 at the Treasure Chest mine (now part of the Treasure mine shown in Figure 2) was 30 to 50 metres thick and 360 metres long (Garihan, 1973, p. 149).

The larger talc bodies tend to occur along the contact of dolomitic marble with other rock types. At the Willow Creek mine the talc body is in dolomitic marble along the contact with quartzofeldspathic gneiss; underlying calcitic marble is barren of talc (Figure 4). Gneiss or schist in contact with talc-bearing marble is typically altered. Most intensely altered gneiss is completely chloritized. Where less intensely altered, only feldspars and biotite are chloritized, and in the least altered gneiss feldspars are sericitized. Sillimanite schist adjacent to talc occurrences in the marble shows chloritization of biotite and sericitization of chlorite.

HIGHLAND MOUNTAINS

Because of the general lack of marble in this range, talc deposits have not been found. However, chlorite is mined at the Antler mine and occurs in quartzofeldspathic gneiss along northwest-trending faults. Further prospecting in this range may reveal other deposits of chlorite.

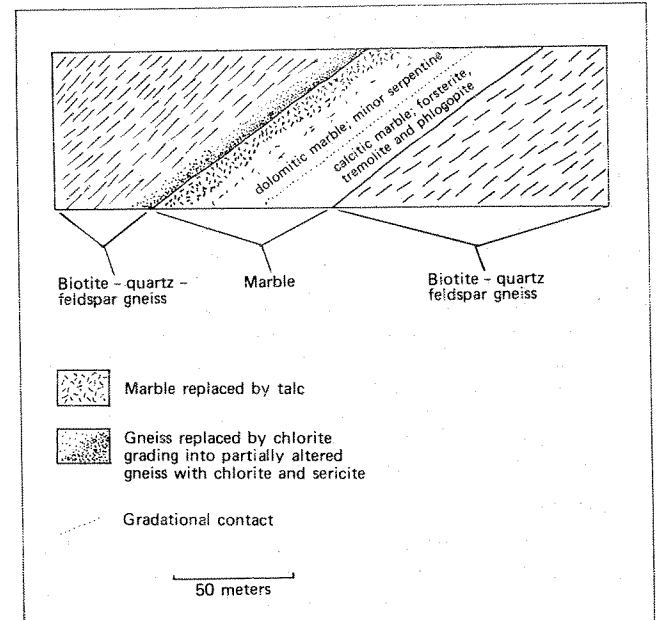

Figure 4. Diagrammatic cross section of the Willow Creek mine showing the relationship between gneiss, marble and alteration assemblage. (modified slightly from Berg, 1979a, Figure 16).

TOBACCO ROOT MOUNTAINS

Talc occurrences in the Tobacco Root Mountains are concentrated in the southwestern part of the range where marble is most abundant. There are six talc prospects and two inactive mines. Further exploration is warranted along the marble layers in the southwestern part of the range.

RUBY RANGE

The greatest concentration of talc mines and prospects in Montana is in the Ruby Range where in addition to the Beaverhead and Treasure mines, talc has been intermittently mined in recent years from the Regal mine. Development work has recently been done on two other prospects by Cyprus Industrial Minerals Company and The Montana Talc Company. Seven inactive mines and eleven prospects have been described in this mountain range. (Olson, 1976 and Berg, 1979). Also there are many other occurrences of talc. Because of this concentration of talc occurrences, research on talc deposits in Montana has largely been confined to the Ruby Range (Anderson, Mogk, and Childs, 1990; Blount and Parkison, in press; Garihan, 1973; Okuma, 1971; Olson, 1976; Piniazkiewicz, 1984; and Whitehead, 1979).

GREENHORN RANGE

In the Greenhorn Range to the east of the Ruby Range (Figure 1) there is one inactive talc mine, the Willow Creek mine, and six prospects. Thirty eight other talc occurrences have been noted (Berg, 1979a). Only six of the twenty two occurrences that are on east-west drainages are on north-facing slopes. Obviously prospecting for talc by looking for chips in the soil has its limitations on wooded north-facing slopes where thick soil is developed.

GRAVELLY RANGE

Although there are only two prospects and two mines in the Gravelly Range, this range is significant because of the large amount of talc within a small area. About 30 kilometres south of Ennis on the east flank of the Gravelly Range dolomitic marble extends for 7 kilometres northwest along strike and is almost 3 kilometres wide (Hadley 1969a and b). This marble is unconformably overlain by Cambrian sedimentary rocks to the southwest and by Quaternary alluvium to the northeast. The talc deposit mined at the Johnny Gulch mine and the deposit mined at the Yellowstone mine are both within this marble body. There is also a small, inactive mine situated east of the Yellowstone mine near the contact between marble and alluvium. Some magnesite occurs at this smaller talc mine. For whatever reason, conditions obviously favored the formation of a very large quantity of talc in a small area. The large talc deposits within this small area suggest that exploratory drilling could identify other talc bodies now concealed.

MADISON RANGE

No talc prospects have been reported within the Madison Range even though there are occurrences of marble within the Archean metamorphic rocks exposed in this rugged mountain range. Erslev (1983, p. 23) reported the occurrence of blackwall reaction zones that contain talc mixed with chlorite, magnesite, actinolite and anthophyllite around some of the ultramafic pods. At the Cliff asbestos mine, where an attempt was made to

mine chrysotile asbestos, some talc also occurs. Here serpentine and talc occur next to a Precambrian post-metamorphic diabase dike.

HENRYS LAKE MOUNTAINS

Precambrian metamorphic rocks, probably also of Archean age, are widely exposed in the Henrys Lake Mountains (Figure 1). Minor talc occurrences are found along mafic dikes that intrude dolomitic marble. These mafic dikes are probably the same age as one of the sets of mafic dikes described from the Tobacco Root Mountains and other areas of Archean metamorphic rocks in southwestern Montana (Wooden and others, 1978). Although this area was mapped in detail and dolomitic marble was examined for talc occurrences, the only talc found is in dolomitic marble along igneous contacts (Berg, 1979a, p. 58). These occurrences as well as the talc at the Cliff asbestos mine, are the only localities in southwestern Montana where talc is found next to igneous rocks. It is clear that the mechanism for the formation of most talc deposits in Montana differs from that responsible for this contact-metamorphic talc.

The Lynx Creek (Mathews) talc deposit in northwestern Montana near Troy is unusual because it is the only known talc deposit in the Proterozoic Belt Supergroup. Shallow drill holes at this deposit have delineated a talc body 30 by 76 metres and extending at least 12 metres in depth (Johns, 1970, p. 152). Host rock is argillite and quartzite of the Striped Peak Formation of the Missoula Group. Talc exposed at the surface is light greenish gray and locally iron stained. X-ray diffraction analysis shows a sample to consist mainly of talc and minor chlorite. The Lynx Creek talc deposit in Belt metasedimentary rocks raises the intriguing possibility of additional talc occurrences in the Belt Supergroup.

The only mined talc deposit in Montana not in Archean metamorphic rocks is a small deposit south of Helena mined underground on a small scale in the 1940's (Anderson, 1942). A talc vein occurs in dolostone of the Cambrian Hasmark Formation (Breuninger and Childs, 1987, p.39). The talc in this deposit is unusually white and may be related to the Cretaceous Boulder batholith exposed a little over three kilometres to the south. Outlying bodies (apophyses?) of the batholith are exposed within 1 kilometre of the deposit.

MINERALOGY AND CHEMISTRY

Examination of selected talc specimens by X-ray diffraction analysis and scanning electron microscopy (SEM) shows uniformly high purity but substantial textural differences.

A specimen of unusually slippery talc from the Doubtful claim in the Greenhorn Range consists of relatively coarse-grained talc platelets exhibiting a swirled texture (Figure 5 A). In contrast a specimen of very pale green talc from the Willow Creek mine, typical of much of the talc mined in Montana, consists of very fine-grained talc with a suggestion of fractures intersecting at oblique angles, perhaps mimicking rhombohedral cleavage of precursor dolomite (Figure 5 B). Figure 5 C is an example of the rare occurrence of talc pseudomorphs after tremolite blades, some up to 4 centimetres long. The strong alignment of talc platelets in this pseudomorph produces an usually platy talc. A specimen of lava talc, demonstrates yet a different texture characterized

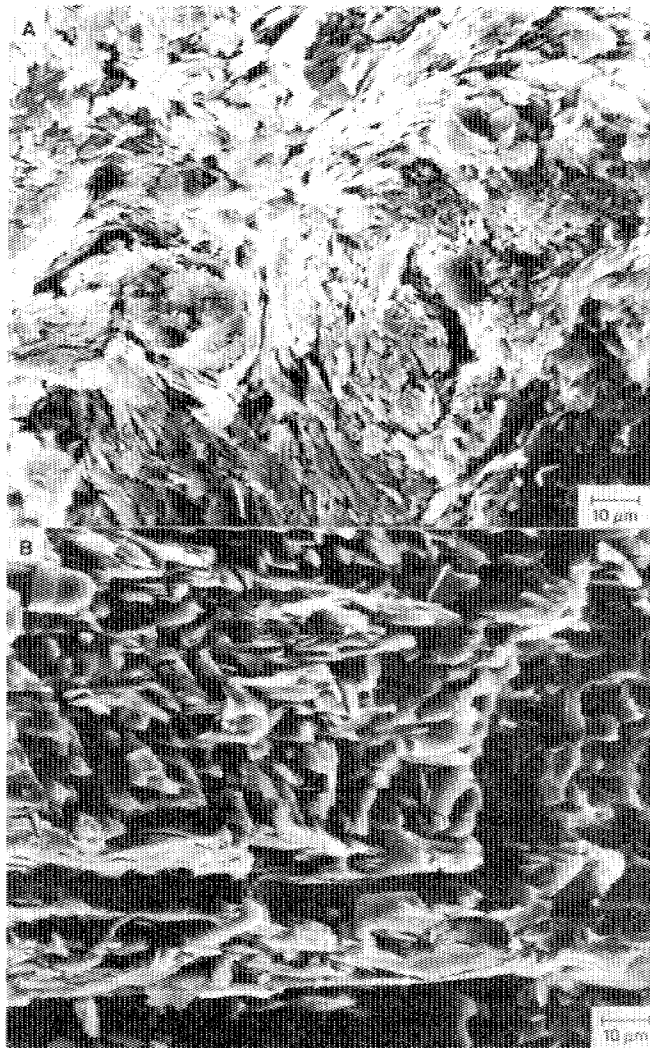
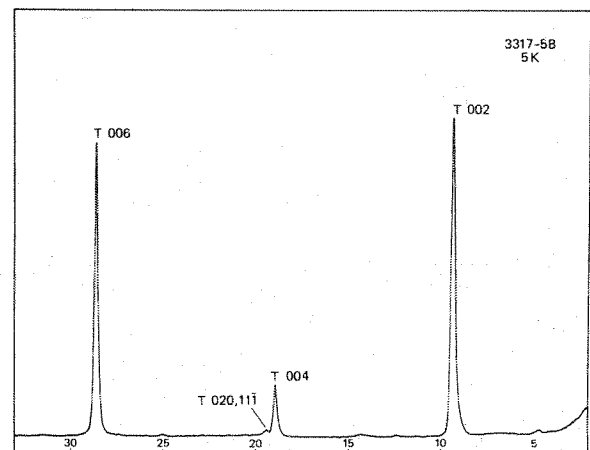
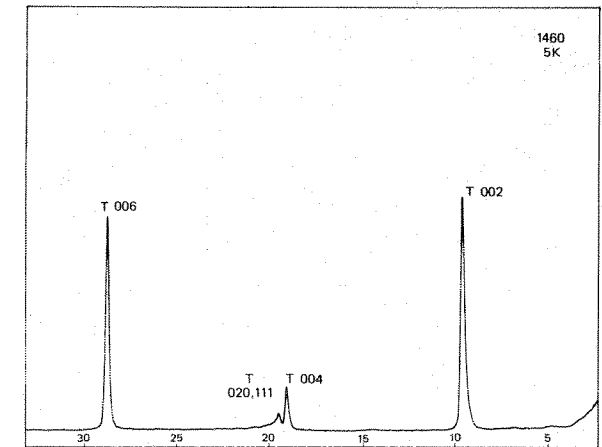

Figure 5. SEM micrographs and x-ray diffraction traces of selected talc and chlorite specimens from southwestern Montana. SEM micrographs taken by William Huestis using an International Scientific Instruments model ISI 40 scanning electron microscope at Montana Tech. X-ray diffraction traces of powdered samples packed in metal sample holder and scanned at $2^\circ 2\theta$ /minute using $\text{CuK}\alpha$ radiation, a diffracted-beam monochromator and 1° divergence and receiving slits. Range in counts per second is indicated on each trace. T = talc and C = chlorite. Chemical analyses of four of these specimens are given in Table 1. A. Specimen 1460 - Talc from the Doubtful claim in the NW1/4 SW1/4 sec. 14, T.8 S., R.4 W. in the Greenhorn Range. B. Specimen 3317-5B - Talc from the Willow Creek mine in the NE1/4 sec. 30, T.8 S., R.3 W. in the Greenhorn Range.

by what appear to be masses of very fine-grained talc (Figure 5 D). Lava talc is found only in the upper part of the talc deposits in the area south of Ennis and appears to be formed by extensive weathering of more massive talc which constitutes the bulk of these deposits. A comparison of chemical analysis of this specimen with the specimen of talc from the Willow Creek mine (Table 1) shows little difference. The major difference is in less total iron in the lava talc than in the talc from the Willow Creek mine.

Comparison of the x-ray diffraction traces of these four specimens of texturally dissimilar talc are remarkably similar (Figures 5 A - D). In these highly oriented samples prepared by packing a powdered sample into a metal sample holder, the only mineral detected was talc. The major difference between x-ray diffraction traces of these samples is in the degree of preferred orientation as indicated by the relative intensities of the 002, 004 and 006 peaks compared to the nonbasal 020 and 111 peaks. Only those peaks produced by diffraction from basal



planes were detected in specimen 3961 which consists of tremolite replaced by talc. Samples 1460 and 3317-5B show nonbasal peaks to only a limited extent whereas the lava talc, perhaps because of very small grain size, exhibits the least preferred orientation as evidenced by relatively strong 020 and 111 peaks and reduced intensity of the basal reflections.

The two chlorite specimens, both green in hand specimen, have similar texture (Figures 5 E and F). Both consist of large platelets (up to 20 m across) with no readily discernible preferred orientation. X-ray diffraction traces of these two specimens indicate strong preferred orientation, probably caused by the large grain size. The only mineral detected in addition to chlorite was talc in trace concentration. The greatest difference in chemical composition of these two chlorite specimens is in the Fe_2O_3 and FeO content (Table 1). Research presently underway on the formation of chlorite in the Highland Mountains suggests that total iron content of the precursor gneiss has a major influence on the iron

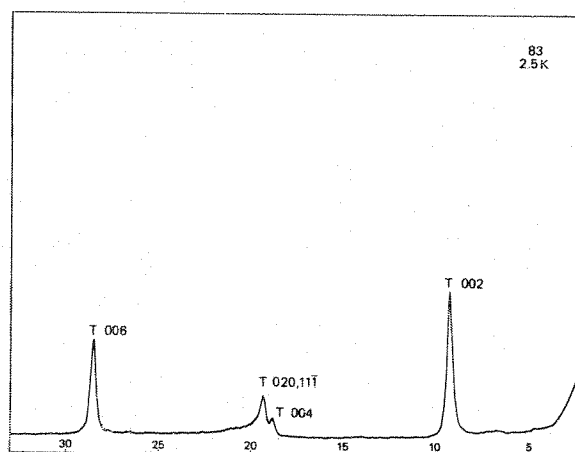
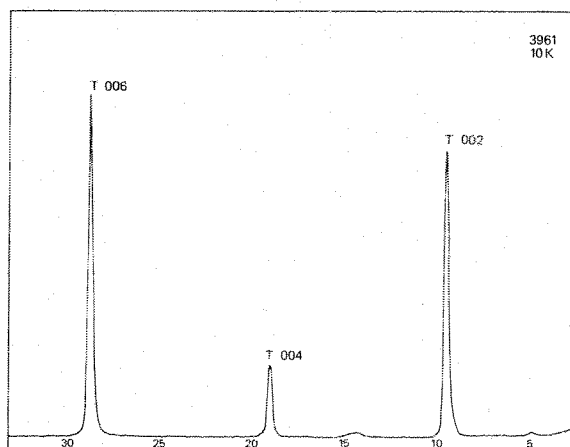
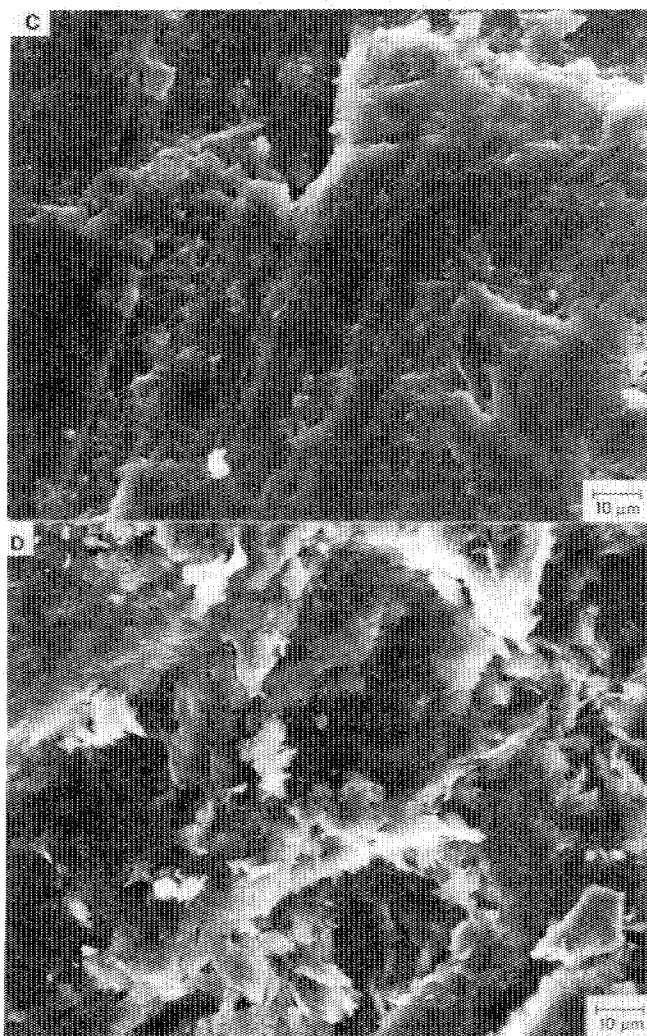

Figure 5-C. Specimen 3961 - Talc after tremolite from Harris Creek prospect in the SW1/4 sec. 13, T.5 S., R.4 W. in the Tobacco Root Mountains.
 D. Specimen 83 - Lava talc from the Cherry Gulch prospect in the NE1/4 SW1/4 and NW1/4 SE1/4 sec. 31, T.8 S., R.1 W. in the Greenhorn Range.

TABLE 1
CHEMICAL ANALYSES OF SELECTED SPECIMENS OF TALC AND CHLORITE FROM SOUTHWESTERN MONTANA. SEE FIGURE 5 FOR LOCALITY INFORMATION

	TALC		CHLORITE	
	3317-5B ¹	83 ¹	3316-6 ¹	4056 ²
SiO ₂	62.42	62.84	32.41	29.93
TiO ₂	0.04	0.11	n.d.	0.22
Al ₂ O ₃	0.45	0.37	18.16	21.83
Fe ₂ O ₃	0.51	0.34	0.61	0.78
FeO	2.24	1.02	6.16	2.55
MnO	n.d.	n.d.	n.d.	0.08
MgO	29.35	30.43	31.24	29.80
CaO	0.01	0.04	0.04	0.11
Na ₂ O	0.02	0.04	0.01	0.03
K ₂ O	0.01	0.02	0.01	<0.01
P ₂ O ₅	n.d.	n.d.	n.d.	<0.05
H ₂ O ⁺	4.79	4.51	12.73	13.5
H ₂ O ⁻	0.09	0.29	0.31	<0.01
Total	99.93	100.01	101.68	98.99

¹ Analysis from Berg, 1979a, p. 8
² Analysis from Berg, 1986, p. 497

content of the chlorite, probably the reason for the difference in FeO between the two analyzed specimens. This brief glimpse of talc and chlorite textures indicates that this may be a productive area of research in understanding the formation of these deposits.

CONTROLS ON TALC FORMATION

LITHOLOGIC

All of the talc that has been mined in southwestern Montana occurs in dolomitic marble layers in the sequence of Archean metamorphic rocks. The most useful guide for talc exploration has been to map the layers of dolomitic marble and explore for talc within these areas. The presence of Mg in the dolomitic marble has been thought necessary for the formation of talc, with introduction of H₂O and some SiO₂ (Garihan, 1973; Olson, 1976; Berg, 1979a), but Anderson, Mogk and Childs (1990) suggested that Mg was also introduced, resulting in the replacement of calcite by dolomite and the formation of talc. Regardless of source of Mg, the association of talc with dolomitic marble seems consistent and is the most useful prospecting guide.

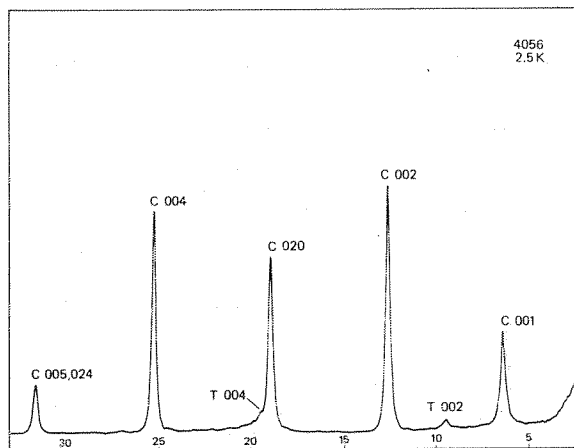
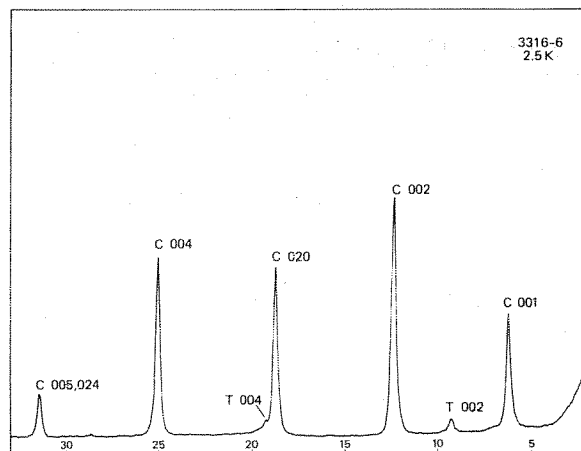
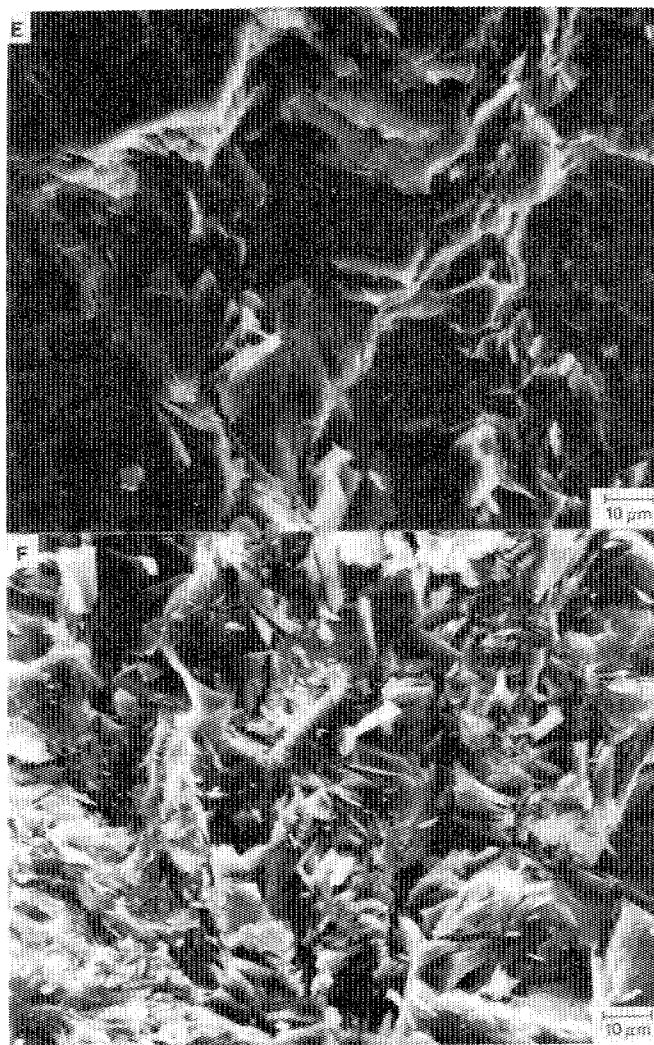

Figure 5-E. Specimen 3316-6 - Chlorite containing a trace of talc from the Willow Creek mine in the NE1/4 sec. 30, T.8 S., R.3 W. in the Greenhorn Range.
 F. Specimen 4056 - Chlorite (variety clinochlore) containing a trace of talc from the Antler mine in the SW1/4 sec. 14, T.2 S., R.6 W. in the Highland Mountains.

The association of talc with dolomitic marble is clearly seen in the vicinity of Ruby Peak in the northern part of the Ruby Range where three distinct varieties of marble are exposed, calcitic marble, dolomitic marble and marble consisting of both calcite and dolomite (Berg, 1987). Although there are scattered occurrences of talc in the calcite-dolomite marble, almost all talc occurs in the dolomitic marble and no talc occurrences were recognized in the calcitic marble (Table 2).

STRUCTURAL

The importance of structure in localizing talc formation in southwestern Montana is not clear. Garihan (1973, p. 186) observed that talc occurrences in the Ruby Range are concentrated in areas of tight folding. Farther south in the same mountain range, Okuma (1971, p. 98) suggested that talc is associated with northwest-trending faults, but more recent maps (Pearson and others, 1990) do not show this relation either in the Ruby Range or in the Tobacco Root Mountains. Structural control along faults was not recognized in the Greenhorn Range either (Berg, 1979a). Anderson, Mogk and Childs (1990, p. 593) suggested that structures parallel or subparallel to layer-

ing in marbles controlled movement of the fluids responsible for talc formation.

In contrast to the apparent lack of consistent relationship between talc occurrences and faults, many chlorite occurrences in quartzofeldspathic gneiss of the southern part of the Highland Mountains are along high-angle, northwest-trending faults.

FORMATION OF TALC AND CHLORITE

The formation of major talc deposits of southwestern Montana commonly has been considered to be a simple replacement of dolomitic marble, but volumetric and chemical considerations suggest that some revision of this interpretation is necessary. Further any mechanism for talc formation must also consider formation of the closely related chlorite and the consistent occurrence of talc only in dolomitic marble.

The generally accepted explanation for talc formation requires that only H₂O and some SiO₂ were introduced to form talc by the following reaction (Garihan, 1973; Berg, 1979a).

TABLE 2
COMPARISONS OF THREE VARIETIES OF
MARBLE FROM THE VICINITY OF RUBY PEAK

	TYPE I	TYPE II	TYPE III
Contains talc	No	Rarely	Most commonly
Estimated abundance of this variety	20%	50%	30%
Outcrop	Rounded	Irregular with solution along joints	Slabby and angular
Color of weathered surface	White to light gray	Brown to very dark brown	Tan
Color of fresh surface	White	Tan overall Dolomite-honey Calcite-white	white
Texture	Granular	Dolomite porphyroblasts surrounded by calcite	Granular
Grain Size	2-10 mm	2-5 mm	2-7 mm
Layering	Rarely recognizable	Caused by variation in abundance of dolomite Layers 1 cm to 1 m thick. Some quartz layers and boudins a few cm thick	Quartz layers and boudins Overall quartz content <10%
Mineralogy	Calcite	Calcite Dolomite Quartz Graphite Phlogopite Diopside Forsterite Tremolite Spinel Anthophyllite Biotite (in quartz only) K-feldspar	Dolomite Quartz Graphite
Alteration	None	Forsterite to serpentine Rare chrysotile veinlets a few mm thick Rare talc after tremolite Very rare talc pods a few cm long	Numerous talc veinlets and pods typically < 30 cm thick

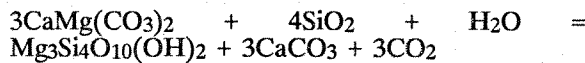

Because calcite is not found in significant quantities with talc, calcite and CO₂ must have been removed from the vicinity of talc deposits resulting in a substantial volume loss. If all SiO₂ and H₂O were introduced, the final volume according to the above reaction would be 71 per cent of the starting volume. If sufficient SiO₂ was present in the dolomitic marble initially, the final volume would be only 48 per cent of the starting volume. Although quartz occurs in dolomitic marble, it does not occur in sufficient concentration for complete replacement of marble by talc. At least some SiO₂ must have been introduced. Following this reasoning, a volume reduction of between 39 and 52 per cent should have accompanied replacement of dolomitic marble by talc.

In large talc bodies, faulting might account for this large loss in volume (Berg, 1979a), but in general there

is no evidence of such volume change. Anderson, Mogk and Childs (1990) presented convincing textural evidence that no significant volume change accompanied the replacement of dolomite by talc. Also, rare, talc pseudomorphs after a rhombohedral carbonate, some up to 2 centimetre in maximum dimension, require essentially volume for volume replacement. The only mechanism for replacement of dolomite by talc accompanied by removal of calcite and CO₂ without volume loss is the introduction of Mg. Piniakiewicz (1984) recognized this problem and suggested that pore fluid in dolomitic marble was a source of Mg. Anderson, Mogk and Childs (1990) presented evidence not only for the volume for volume replacement of dolomite by talc, but also evidence of replacement of calcite in the marble by dolomite. In the deposits that they studied in the Ruby Range, calcite grains were in some instances rimmed by dolomite and replacement of calcite by dolomite occurred along calcite cleavage.

They suggested that introduction of additional Mg as well as SiO₂ and H₂O finally resulted in replacement of dolomite by talc.

Field evidence clearly indicates introduction of Mg into the metamorphic rocks of southwestern Montana. Two quartz veins surrounded by a selvage of chloritic alteration cut quartzofeldspathic gneiss and a post-metamorphic pegmatite dike exposed in a roadcut east of Norris (Figure 6). Not only was SiO₂ introduced to form the vein, but also Mg and H₂O. This caused the replacement of feldspars in the gneiss by chlorite and even partial replacement of quartz by chlorite. If these same solutions had migrated along a fracture cutting marble and this had occurred within the talc stability field, replacement by talc rather than chlorite would have taken place. The major controlling factor in the formation of chlorite rather than talc is the availability of Al. Metamorphic rocks adjacent to talc deposits that contain Al are in many instances partially chloritized.

On a larger scale, the Antler chlorite deposit on the southeast flank of the Highland Mountains, formed by the replacement of quartzofeldspathic gneiss. A composite sample of unaltered quartzofeldspathic gneiss collected near the vein contains only 0.6 weight per cent MgO (Berg, 1983, p. 350) whereas a representative specimen of chlorite (variety clinocllore) from this deposit contains 29.80 weight per cent MgO (Table 1). Obviously this deposit required the introduction of large quantities of Mg. In addition to the Antler chlorite deposit, chloritic alteration occurs along some of the high-angle faults on the southern flank of the Highland Mountains.

Although most talc in southwestern Montana formed by the replacement of dolomite, some formed by replacement of tremolite porphyroblasts.

Pseudomorphs of talc after tremolite up to 4 centimetres long occur at the Harris Creek prospect on the southwestern flank of the Tobacco Root Mountains (Figure 5 C). Replacement of tremolite by talc can take place by several reactions.

One possible reaction is:

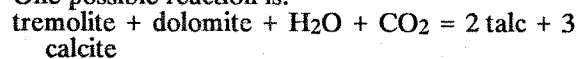

Temperature of talc formation in southwestern Montana has generally been estimated to be around 400°C. Garihan (1973, p. 189) estimated temperatures to be in the range of 300 - 500°C. and Berg (1979a, p. 13)

estimated a temperature between 400 and 500°C on the basis of replacement of tremolite by talc. Anderson, Mogk and Childs (1990, p.597) indicated a temperature for deposits in the Ruby Range of 400°C and P 2 kilobars. All of these estimates of temperature have been based on a low mole fraction of CO₂.

It is uncertain whether all talc in southwestern Montana formed at the same time, but it is clear that it did not all form under the same conditions. Talc exposed at the Yellowstone and Johnny Gulch mines is different in several respects from the talc bodies at the Willow Creek, Beaverhead or Treasure mines. At these latter three mines the pre-faulting configuration of the talc body was essentially a tabular mass parallel to contacts of the marble with adjacent rock types (Figure 4). In contrast the talc at the Yellowstone mine forms many discrete bodies elongate parallel to lithologic layering in the marble (Perry, 1948). Bodies at the Yellowstone mine range up to several metres in thickness. Evidence of talc deposition in open space is shown by the occurrence of botryoidal talc, only very rarely found in other areas, and a complex sequence of talc and silica deposition is indicated for these Johnny Gulch deposits. Here talc has filled the interstices between quartz crystals and in turn is veined by quartz. Brecciated talc has been recemented by talc. These relationships have not been observed at other deposits.

FORMATION OF LAVA TALC

Lava talc, also called block talc, was mined at the Yellowstone mine in the 1940's because this variety of talc could be machined into shapes and then fired and used for insulators. It differs from typical talc in being almost white as compared to the pale green color of most talc from Montana. Some lava talc is penetrated by dendritic patterns of secondary manganese minerals. Lava talc occurs only in the vicinity of the Johnny Gulch and Yellowstone mines south of Ennis and according to Perry (1948, p. 9) is found at the surface of the deposit. Perry suggested that it formed by extensive weathering of the typical talc of this deposit. He pointed out that lava talc has essentially the same chemical composition as other talc from the Yellowstone mine and apparently differs only in texture. A SEM micrograph of lava talc from this area (Figure 5 D) shows it to be much finer grained than most talc. Perhaps extensive weathering caused the recrystallization of talc to produce this variety of non-foliated, fine-grained talc.

Remnants of Tertiary rhyolitic ash-flow tuff overlay the Johnny Gulch deposits (Hadley, 1969a and b). This is the only area in southwestern Montana where volcanics overlie talc deposits and also the only area where lava talc is found. The lava talc may have been formed by extensive weathering that accompanied development of the pre-volcanic erosion surface.

TIME OF TALC FORMATION

Broad constraints on time of talc formation in southwestern Montana can be applied with confidence, but as an attempt is made to further limit time of talc formation, more tenuous inferences become necessary. No radiometric dates are available on talc or the associated alteration assemblage. Talc formed after amphibolite-facies metamorphism of Archean rocks in southwestern

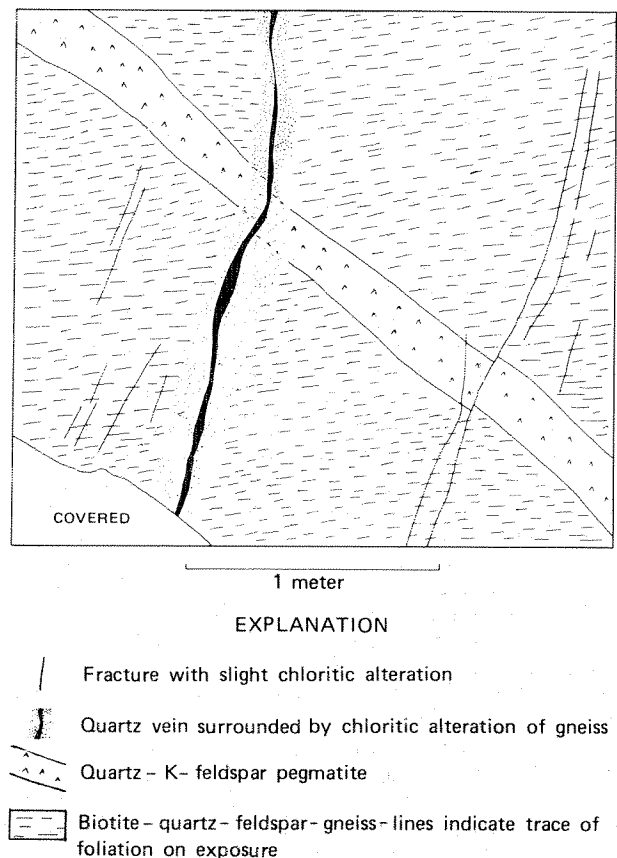

Figure 6. Quartz-chlorite vein cutting post-metamorphic pegmatite dike and Archean biotite-quartz-feldspar gneiss. Exposed in roadcut in the NE1/4 NE1/4 SE1/4 sec. 8, T.3 S., R.1 E. along Montana Highway 84 6.4 km east of Norris.

Montana and after the development of the penetrative fabric associated with this metamorphism. Talc bodies cut across metamorphic fabrics and alteration next to talc bodies resulted in replacement of anhydrous metamorphic minerals with hydrous minerals. Sillimanite and feldspars are sericitized and feldspars are chloritized. Rb-Sr whole-rock analyses of metamorphic rocks from the Tobacco Root Mountains, Ruby Range, and from the Gallatin Canyon to the east indicate a metamorphic age of 2 750 Ma (James and Hedge, 1980). The minimum age of talc formation, as stated in every article on talc in Montana, is Proterozoic, based on the lack of talc occurrences within Paleozoic rocks exposed in and around many of the mountain ranges of southwestern Montana. Dolomitic units occur within the Paleozoic sequence in this area and if talc formed by replacement of dolomite during the Phanerozoic, there should be talc occurrences in these rocks. Thus talc formation can be restricted to the latter part of the Precambrian.

The time span of possible talc formation can be further narrowed on the basis of the relation between talc occurrences and mafic dikes. A post-metamorphic diabase dike at the Ruby claim in the Greenhorn Range has been replaced locally by chlorite (Berg, 1979a, p. 40 to 42). A small talc pod occurs adjacent to the dike in dolomitic marble leading to the conclusion that both talc and chlorite formed at the same time, after the emplacement of the dike.

Wooden and others (1978) were able to recognize three sets of mafic dikes in the southern Tobacco Root Mountains based on whole-rock Rb-Sr determinations and chemical composition. The oldest dikes are approximately 1455 Ma old and the two younger sets were intruded between 1120 and 1130 Ma ago. If the altered dike at the Ruby claim belongs to one of these sets of dikes, chlorite and talc exposed there must have formed since 1455 Ma. Mafic dikes that intruded quartzofeldspathic gneiss on the southern flank of the Highland Mountains are cut by chlorite veins.

In the western part of the Highland Mountains metasedimentary rocks of the LaHood Formation of the Middle Proterozoic Belt Supergroup are separated from Archean metamorphic rocks by a north-dipping fault along which O'Neill, Duncan and Zartman (1988) indicated only small displacement. On the north side of Soap Gulch in Sec. 1, T. 2 S., R. 9 W. about 5 kilometres north of areas of chloritic alteration in the Archean metamorphic rocks to the south, chloritic alteration occurs along NW-trending quartz veins. In hand specimen the altered rock has a decided green color and in thin section chloritization of feldspars is evident. If this chloritization in the LaHood Formation is related to that in the Archean metamorphic rocks in this area, this process occurred after lithification of this section of the LaHood Formation, the oldest formation in the Belt Supergroup in this part of southwestern Montana. The Middle Cambrian Flathead Formation unconformably overlies both Proterozoic sedimentary and Archean metamorphic rocks. Quartz veins and associated chloritic alteration extend up to this unconformity, but have not been recognized in the Flathead Formation or overlying Paleozoic formations.

Lithology of clasts in the coarse-grained facies of the LaHood Formation of the Belt Supergroup exposed north of the Tobacco Root Mountains provides an inference concerning time of dolomitization of Archean marbles. This formation has been interpreted to be syntectonic, deposited next to an E-W trending fault zone that forms the southern margin of the Belt basin (Winston, 1986). It contains rounded clasts of hornblende gneiss and quartzofeldspathic gneiss like that commonly exposed in the mountain ranges to the south. Almost all of the marble clasts are fine-grained calcitic marble generally containing tremolite layers a few millimetres thick. The lithology of these clasts contrasts strongly with the coarse-grained dolomitic marble generally devoid of calcsilicate minerals which is the dominant marble in the Archean rocks exposed in the mountain ranges in southwestern Montana.

Either the source of marble clasts in the LaHood Formation must have differed from that now exposed in southwestern Montana where dolomitic marble is much more abundant than calcitic marble, or dolomitization of the marble occurred after erosion of these clasts. The latter possibility seems more likely as there is no reason to expect that the calcitic marble was somehow preferentially eroded over the presently more abundant dolomitic marble. If so dolomitization of Archean marble, and by inference, the time of talc formation was after erosion of detritus that is now incorporated in the LaHood Formation.

The source of Mg locally concentrated in Archean rocks in southwestern Montana to form talc and chlorite

is problematical. Either Mg was locally derived from surrounding Archean or Proterozoic rocks or it was introduced from an external source. Mafic dikes, amphibolite layers, hornblende gneiss and rare ultramafic bodies with the Archean metamorphic rocks are potential sources of Mg. If Mg had been derived by leaching of these rocks, alteration of Mg-bearing minerals and other silicates would be expected. Such alteration has not been observed. Chlorite veins at the Antler mine in the Highland Mountains cut both an amphibolite layer and a metabasite dike within the quartzofeldspathic gneiss surrounding this deposit. Except for replacement where this chlorite vein cuts these rocks, they appear unaltered indicating that these magnesian rocks could not have been a source of Mg for the development of this vein.

Anderson, Mogk and Childs (1990) suggested that the Proterozoic Belt Sea was the source of Mg for dolomitization of Archean carbonates and formation of talc deposits. The major objection to this source is that the Belt Sea did not cover the area of talc deposits in southwestern Montana. The southern boundary of this sea was the Willow Creek fault zone which extends east-west just north of the area of exposed Archean metamorphic rocks in the Highland Mountains and Tobacco Root Mountains (Figure 1). If the Belt Sea was the source of Mg, sea water must have migrated laterally to the southwest along more permeable zones in the metamorphic rocks. Formation of chlorite deposits in the Highland Mountains would not have required movement of sea water for such distances as these deposits are close to the margin of the Belt Sea. At this stage of our understanding the Belt Sea seems to offer the best possibility as a source of Mg for the formation of both talc and chlorite deposits.

SUMMARY

Economically important talc deposits are confined to dolomitic marble within the Archean rocks of southwestern Montana. Only one occurrence is known in the Proterozoic Belt Supergroup in Montana. Field relationships indicate that Mg was introduced into the Archean metamorphic rocks and at least the lowest part of the metasedimentary rocks of the Belt Supergroup. However there is no indication that Paleozoic sedimentary rocks were altered to talc or chlorite during this event. A control on the formation of talc and chlorite was the availability of Al in the host rock; where Al was present in the rock, formation of chlorite was favored, but in carbonate rocks lacking Al, talc formed. It is suggested that Al-bearing rocks in the Archean Wyoming province of southwestern Montana and the lower part of the Belt Supergroup, are possible host rocks for chlorite deposits and carbonate rocks in the same sequence of Archean and Proterozoic rocks are potential host rocks for talc deposits.

ACKNOWLEDGMENTS

This continuing investigation of talc and chlorite deposits in Montana benefitted from the suggestions and observations of other geologists. Hugh Dresser showed me quartz veins in the LaHood Formation which subsequently led to the recognition of associated chloritic alteration in this formation. John Childs suggested that it might be worthwhile to examine clasts in the LaHood Formation for the presence of talc. Reviews of this paper by Robert L. Virta, John F. Childs, Robert C. Pearson

and Edward T. Ruppel contributed to its improvement and are appreciated.

REFERENCES

- Anderson, D.L., Mogk, D.W. and Childs, J.F. (1990): Petrogenesis and Timing of Talc Formation in the Ruby Range, Southwestern Montana; *Economic Geology*, Volume 85, pages 585 to 600.
- Anderson, H.N. (1942): Helena and Ennis Talc Deposits; B.S. thesis, *Montana School of Mines (Montana Tech.)*, 30 pages.
- Berg, R.B. (1979a): Talc and Chlorite Deposits in Montana; *Montana Bureau of Mines and Geology*, Memoir 45, 66 pages.
- Berg, R.B. (1979b): Precambrian Geology of the West Part of the Greenhorn Range, Madison County, Montana; *Montana Bureau of Mines and Geology*, Geologic Map 6, Scale 1:28,570.
- Berg, R.B. (1983): New Chlorite Mine in an Old Montana Gold District; *Mining Engineering*, Volume 35, pages 347 to 350.
- Berg, R.B. (1986): Clinocllore from the Silver Star District, Madison County, Montana; *Clays and Clay Minerals*, Volume 34, Number 4, pages 496-498.
- Berg, R.B. (1987): Potential for Talc Deposits within the BLM Wilderness Study Area of the Northern Part of the Ruby Range, Madison County, Montana; *U.S. Geological Survey*, Open-File Report 87-001, Map with text, Scale 1:24,000.
- Bergantino, R.N. and Clark, M. (1985): Structure Contour Map on Top of Precambrian Crystalline Rocks; *Montana Bureau of Mines and Geology*, Open-File Report MBMG 158, Scale 1:1,000,000.
- Blount, A.H. and Parkison, G.A. (in press) Hydrothermal Alteration Haloes and Enlarged Soil Anomalies over Concealed Talc Bodies, Southwestern Montana; *Ore Geology Reviews*, Volume 6.
- Breuninger, R.H. and Childs, J.F. (1987): Road Log No. 4, Helena and the North Border Zone of the Boulder Batholith, Montana; in Berg, Richard B. and Breuninger, Ray H., eds., *Guidebook of the Helena Area, West-central Montana*, *Montana Bureau of Mines and Geology*, Special Publication 95, pages 27 to 43.
- Chidester, A.H., Engel, A.E.J. and Wright, L.A. (1964): Talc Resources of the United States; *U.S. Geological Survey*, Bulletin 1167, 61 pages.
- Condie, K.C. (1976): The Wyoming Archean Province in the Western United States; in Windley, Brian F., Editor, *The Early History of the Earth*, *John Wiley & Sons*, New York, pages 499 to 510.
- Cooper, J.D. (1964): Talc, Soapstone, and Pyrophyllite; in *Minerals Yearbook*, 1963, *U.S. Bureau of Mines*, Volume 1, pages 1097 to 1104.
- Erslev, E.A. (1983): Pre-Beltian Geology of the Southern Madison Range, Southwestern Montana; *Montana Bureau of Mines and Geology*, Memoir 55, 26 pages.
- Garihan, J.M. (1973): Geology and Talc Deposits of the Central Ruby Range, Madison County, Montana; Ph.D. dissertation, *Pennsylvania State University*, 209 pages.
- Hadley, J.B. (1969a): Geologic Map of the Cameron Quadrangle, Madison County, Montana; *U.S. Geological Survey*, Map GQ-813, Scale 1:62,500.
- Hadley, J.B. (1969b): Geologic Map of the Varney Quadrangle, Madison County, Montana; *U.S. Geological Survey*, Map GQ-814, Scale 1:62,500.
- James, H.L. (1990): Precambrian Geology and Bedded Iron Deposits of the Southwestern Ruby Range, Montana; *U.S. Geological Survey*, Professional Paper 1495, 39 pages.
- James, H.L. and Hedge, C.E. (1980): Age of Basement Rocks of Southwest Montana; *Geological Society of America*, Bulletin, Volume 91, pages 11 to 15.
- Johns, W.M. (1970): Geology and Mineral Deposits of Lincoln and Flathead Counties, Montana; *Montana Bureau of Mines and Geology*, Bulletin 79, 182 pages.
- Karasevich, L.P. (1980): Structure of the Pre-Beltian Metamorphic Rocks of the Northern Ruby Range, Southwestern Montana; M.S. thesis, *Pennsylvania State University*, 172 pages.
- Krempasky, G.T., Bingler, E.C. and Lawson, D.C. (1982): The Mineral Industry of Montana; in *Minerals Yearbook*, 1980, *U.S. Bureau of Mines*, Volume 2, pages 317 to 327.
- Okuma, A.F. (1971): Structure of the Southwestern Ruby Range near Dillon, Montana; Ph.D. dissertation, *Pennsylvania State University*, 122 pages.
- Olson, R.H. (1976): The Geology of Montana Talc Deposits; in Rooney, Lawrence F., and Berg, Richard B., eds., *Eleventh Industrial Minerals Forum*, Proceedings, *Montana Bureau of Mines and Geology*, Special Publication 74, pages 99 to 143.
- O'Neill, J.M., Duncan, M.S. and Zartman, R.E. (1988): An Early Proterozoic Gneiss Dome in the Highland Mountains, Southwestern Montana; in *Precambrian and Mesozoic Plate Margins*, Lewis, Sharon E. and Berg, Richard B., eds., *Montana Bureau of Mines and Geology*, Special Publication 96, pages 81 to 88.
- Pearson, R.C., Hanna, W.F., James, H.L., Loen, J.S., Moll, S.H., Ruppel, E.T. and Trautwein, C.M. (1990): Map Showing Mineral Resource Assessment for Silver, Cobalt, and Base Metals in Proterozoic Sedimentary Rocks and for Iron, Chromium, Nickel, Talc, Chlorite, Gold, and Graphite in Archean Crystalline Rocks, Dillon 1° x 2 Quadrangle, Idaho and Montana; *U.S. Geological Survey*, Map 1-1803-D, Scale 1:250,000.
- Perry, E.S. (1948): Talc, Graphite, Vermiculite and Asbestos in Montana; *Montana Bureau of Mines and Geology*, Memoir 27, 44 pages.
- Piniakiewicz, R.J. (1984): Geology of and Exploration Techniques for Pre-Beltian Talc Deposits of the Malesich Ranch, Ruby Range, Madison County, Montana; M.S. thesis, *University of Arizona*, 101 pages.
- U.S. Bureau of Mines (1990): The Mineral Industry of Montana, 3 pages.
- Virta, R.L. (1990): Talc and Pyrophyllite; in *Mineral Commodity Summaries*, 1990, *U.S. Bureau of Mines*, pages 168 to 169.
- Vitaliano, C.J., and Cordua, W.S. (1979): Geologic Map of Southern Tobacco Root Mountains, Madison County, Montana; *Geological Society of America*, Map MC-31.
- Whitehead, M.L. (1979): Geology and Talc Occurrences of the Benson Ranch, Beaverhead County, Montana; M.S. thesis, *Montana Tech.*, 53 pages.
- Winston, D. (1986): Sedimentation and Tectonics of the

Middle Proterozoic Belt Basin and their Influence on Phanerozoic Compression and Extension in Western Montana and Northern Idaho; *in* Paleotectonics and Sedimentation in the Rocky Mountain Region, United States, Peterson, James. A. Editor, *American Association of Petroleum Geologists*, Memoir 41, pages 87 to 118.

Wooden, J.L., Vitaliano, C.J., Koehler, S.W. and Ragland, P.C. (1978): The late Precambrian Mafic Dikes of the Southern Tobacco Root Mountains, Montana: Geochemistry, Rb-Sr Geochronology and Relationship to Belt Tectonics; *Canadian Journal of Earth Sciences*, Volume 15, pages 467 to 479.

THE LANG BAY KAOLIN RESOURCE, BRITISH COLUMBIA

By Lauch Farris
Colin C. Harvey

Fargo Resources Ltd., Vancouver, B.C.

Haydn Murray and Associates, Bloomington, Indiana

ABSTRACT

Detailed exploration drilling, laboratory testing and resource evaluation at Lang Bay, British Columbia has defined a primary kaolin clay resource of 6 million tonnes (raw material) and a secondary kaolin resource of tens of millions of tonnes. These clays are located beneath a considerable thickness of glacial till.

The primary kaolin has formed from the alteration of basement granodiorite rocks of the Coast Plutonic Suite. Low temperature hydrothermal alteration is considered to have played a part in this alteration process. The secondary kaolins are part of a cyclothem sequence of sandstones, conglomerates, shales and minor lignites which were deposited in the Lang Bay basin.

The primary kaolin is of low brightness (50 to 70% General Electric) but in laboratory trials it has proven to be successful as a filler clay in newsprint where it contributes to improved opacity, sheet brightness and printability.

The secondary kaolin can be utilized in the manufacture of refractory products and could be a source of aluminum for cement.

The commercial development of this resource de-

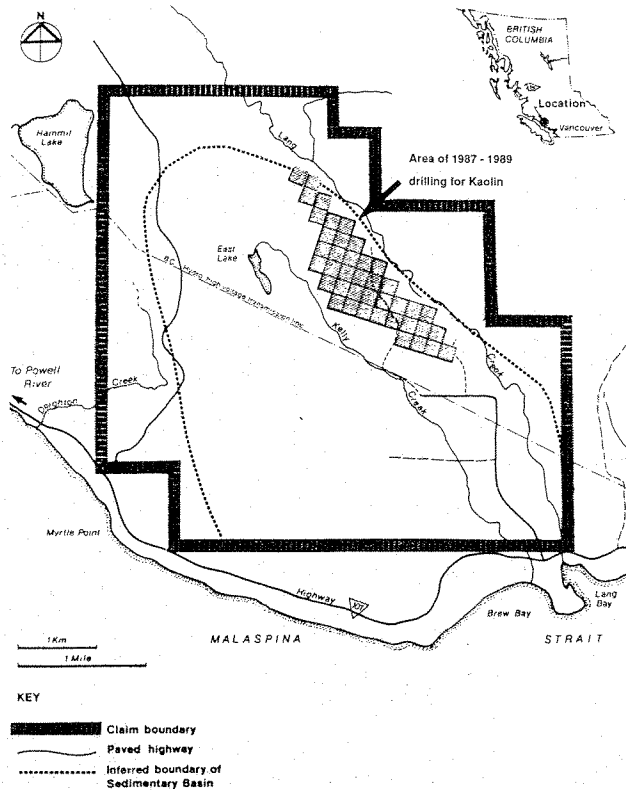

Figure 1. Location map. Lang Bay Kaolin Prospect.

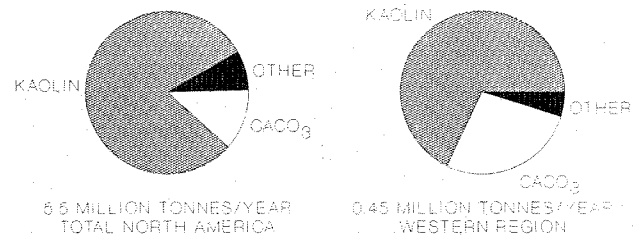

Figure 2. North American papermaking mineral pigments consumption (1989-1990).

pends on securing local markets. The use of Lang Bay kaolin in commercial newsprint manufacture is currently under consideration.

INTRODUCTION

LOCATION

The Lang Bay kaolin prospect is within a group of mineral claims located 15 kilometres southeast of the township of Powell River in British Columbia (Figure 1). Access is off Highway No 101. A B.C. Hydro powerline transects the area. The prospect is only 5 kilometres from tide water which could lead to development of barge traffic immediately south of the claims.

INDUSTRIAL APPLICATIONS

Kaolins are extremely important as industrial minerals and world market for kaolins exceeds 20 million tonnes per year. They are used in a wide variety of industries ranging from ceramics and refractories to paper, plastic, rubber and pharmaceuticals.

In Canada they are a significant component in many industries but the pulp and paper industry is the largest single market area. Figure 2, after Ionides (1991), provides estimates of the total North American market tonnage for pigments in the paper industry and the market size in the Pacific North West. Kaolin is the dominant pigment used and in the Pacific North West its annual tonnage potential is estimated to be 300 000 tonnes per year.

Traditionally the processed kaolins for the Canadian paper industry have come from Georgia in the southeastern U.S.A. and no indigenous resources of kaolins of suitable quality have been developed. With ever increasing freight rates however, attention has recently focussed on exploration for local deposits of these raw materials.

PROJECT HISTORY

In 1948 anomalously high germanium values were found in carbonaceous sediments in the vicinity of Lang

Creek. Mining rights to the area were obtained by Fargo Resources Ltd. who staked the property in 1981. Trenching and sample evaluations were carried out between 1981 and 1985.

In 1986, drilling in the northeast sector of the claims indicated the presence of white kaolin clays which were recognized to have potential as industrial clays. In association with Brenda Mines Ltd. reverse circulation drilling and various geophysical surveys were undertaken during 1987 which provided evidence of a basin structure and extensive clay horizons.

Samples of the clay encountered from this drilling were analyzed in the laboratories of The University of British Columbia (Mak & Chaklader, 1987) with detailed applied testing by several industrial consultant laboratories. These studies concluded that the primary kaolin clays (the in situ altered granodiorite) might have potential as industrial clays in paper, ceramics and refractories, while the secondary clays might be suitable for refractory manufacture.

A core drilling program was initiated in the spring of 1988 which resulted in the development of a geological model of the clay genesis (Harvey, 1988). Samples from this program were evaluated in a number of commercial laboratories which confirmed the clays to have industrial potential. A series of paper-making trials were undertaken by the laboratories of MacMillan Bloedel Research which concluded that the primary kaolin clays could be suitable as low-brightness filler clays in newsprint manufacture.

Based on these encouraging results an airborne geophysical survey and core drilling program was undertaken in the fall of 1988 to fully determine the extent of the resource. The geophysical survey included magnetic and electromagnetic surveys to delineate the basin structure and identify zones of high conductivity which might indicate the presence of subsurface clay horizons. Several of these high conductivity anomalies were subsequently drilled.

A site laboratory was set up to refine the clays and determine the processing requirements. The results of these studies were integrated in 1989 into a resource evaluation and pre-feasibility study by Beaty Geological Ltd., Kilborn Engineering Ltd. and Harvey Scientific Consultants Ltd.

The economic evaluation concluded that the production of a bleached filler clay was not economically viable. It was considered, however, that the kaolin might be acceptable as a wood fibre substitute for use in newsprint manufacture.

Work is currently underway to evaluate this potentially large tonnage kaolin occurrence.

GEOLOGICAL SETTING

On the basis of the drilling carried out to date, a geological model is proposed and is illustrated in Figure 3.

(i) Basement granodiorite rocks of the Coast Plutonic Suite were emplaced during the Jurassic-Cretaceous (180 - 100 million years ago).

(ii) Low temperature hydrothermal alteration occurred along fractures in these basement rocks along with weathering. These actions resulted in the formation of a residual kaolin deposit adjacent to the zone of hydrothermal activity.

(iii) Erosion occurred, during a period of uplift which formed the basin structure at Lang Bay, and which was subsequently filled by a cyclothem sequence of clays, similar to those in coal measures (secondary kaolins), sandstones and conglomerates in the Late Cretaceous. Palynomorphic studies by White (1986) confirm a Cretaceous age for these sediments. These sediments assisted in the preservation of the residual kaolins on the eastern margin of the basin.

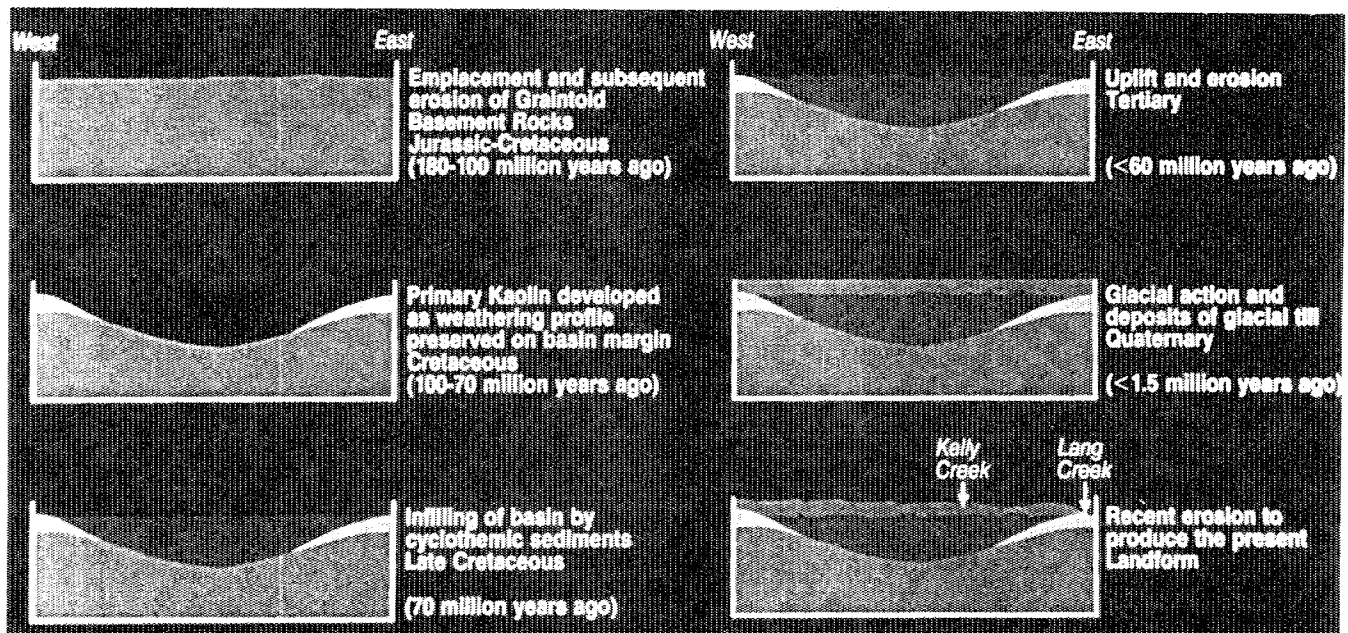

Figure 3. Geologic model.

(iv) Emergence during the Tertiary period produced an irregular erosion surface which was covered by glacial till during the late Tertiary - Quaternary.

(v) Recent erosion has produced the present landform with significant erosion down to unaltered granitoid rocks along Lang Creek. Lang Creek is aligned along a major northeast, southwest trend which is interpreted to be the fault which has provided the conduit for ascending, low temperature hydrothermal fluids.

MINERALOGY

KAOLINIZED GRANITIC ROCKS:

The mineral composition of the basement rocks were investigated using the petrographic microscope. They are classified as granodiorites of composition:

Plagioclase	35-55%
K-feldspar	12-20%
Quartz	25-30%
Biotite	7-12%
Opagues (incl. magnetite)	0-2%
Horneblende & Ilmenite	0-3%

The granodiorite in the kaolinized zone is typically brecciated with extensive microfractures which may be related to the interpreted Lang Creek fault.

Alteration is moderate to intense in the kaolinized zone with horneblende and plagioclase completely altered to kaolin. Towards the top of the profile where kaolinization is most intense the K-feldspar is altered to kaolin while the biotite has degraded to illite. With

increasing depth below the surface the K-feldspar and biotite are less altered.

PRIMARY KAOLIN ALTERATION ZONE:

A combination of techniques were used to investigate changes in the mineralogy with increasing depth; they included,

- (i) the petrographic microscope
- (ii) chemical analyses
- (iii) x-ray diffraction analyses
- (iv) scanning electron microscopy + EDX analyses
- (v) Moessbauer spectrographic analyses
- (vi) Cation exchange capacity

It is beyond the scope of this paper to review these results in detail. However, the major findings of the study are summarized in Table 1.

At the top of the profile the altered granodiorite is composed dominantly of kaolin (50 to 60%) and quartz (25 to 30%) with significant amounts of magnetite and minor biotite, illite and calcite.

In the deeper part of the profile biotite and feldspar, which are residual in the less altered granodiorite, are present in ever increasing amounts. The kaolin content decreases and smectite (swelling clay) content increases.

The chemical changes in the profile are illustrated in Table 2 after Mak and Chaklader (1987).

DRILLING AND LABORATORY TESTING

DRILLING

Drilling of the kaolin at Lang Bay has been carried out intermittently since 1959 when Skerl (1959) identified

TABLE 1
MINERALOGICAL CHANGES WITH DEPTH IN THE PRIMARY KAOLIN PROFILE

CHEMICAL TRENDS	KAOLIN CONTENT	MINERALOGY OF THE 20 MICRON FRACTION	BRIGHTNESS ACHIEVABLE WITHOUT BLEACHING	BOREHOLES
MAGNESIA, IRON & ALKALIES INCREASING WITH DEPTH.	(50-60%)	Kaolin & Minor quartz, Biotite (illite) and Carbonate cement	72	88-3,88-4, 88-13, 88-27
ALUMNIA & HYDRATION (LOI) DECREASING WITH DEPTH.	(40-50%)	Kaolin content decreasing biotite content increasing minor quartz and carbonate still present	60	88-24,88-30, 88-32, 88-33,88-15, 88-16, 88-43,88-44,88-6 88-25
		Kaolin and biotite present as major minerals with minor quartz, carbonate, feldspar & sometimes smectite	50	88-17,88-29,88-42, 88-28,88-34,88-40, 88-39,88-41,88-35
	(13-30%)	Smectite and biotite (illite) major minerals with less kaolin, minor quartz and feldspar	30	88-5, 88-9

TABLE 2
ANALYTICAL DATA OF PRIMARY KAOLIN
(BOREHOLE 87-7 AFTER MAK AND CHAKLADER,
1987)

Drilled Depth (m)	Na ₂ O %	MgO %	Al ₂ O ₃ %	SiO ₂ %	K ₂ O %	CaO %	TiO ₂ %	Fe ₂ O ₃ %	L.O.I. %
18-19	0	0.49	24.23	55.92	0.10	0.83	0.06	5.8	12.53
21-22	0	0.46	23.74	58.35	0.14	0.73	0.02	4.20	12.35
24-25	0	0.64	23.46	56.10	0.23	0.77	0.05	6.37	12.38
27-28	0	0.70	22.99	56.02	0.90	1.21	0.04	5.89	12.24
30-31	0	0.82	19.97	56.90	1.82	1.08	0.03	6.90	12.46
33-34	0.72	0.86	15.85	60.01	1.78	2.36	0.01	5.92	12.47
36-37	0.39	0.90	17.39	57.94	1.92	2.94	0.02	6.14	12.56
39-40	0.34	0.93	16.52	59.30	1.95	2.94	0.02	5.72	12.27

L.O.I. = Loss on ignition

kaolinized granite in various drillholes. However, the commercial significance of the kaolin was not appreciated until 1986 when drilling was undertaken by Fargo Resources Ltd. Extensive core-drilling was carried out between 1988 and 1989 by Fargo Resources Ltd. in a joint venture program with Brenda Mines Ltd. In the area of known kaolinization core drilling was carried out on a 100 metre grid pattern.

TESTING PROGRAM

The altered granodiorite was evaluated in the site laboratory. Samples at 3 metre (10ft) intervals were crushed, wet ground and then fractionated at 20 micrometres to obtain a kaolin-rich product suitable for use as an industrial filler clay.

Standard measurements of recovery, brightness and abrasion were made on this product which confirmed a significant resource of a low brightness filler clay. Brightness values varied from 70 per cent (General Electric) down to less than 50 per cent (GE) with decreasing recovery, and lower brightness at increasing depth below the surface. Abrasion indices were generally less than 20 milligram loss (Einleiner). Recoveries varied from 35 per cent recovery at 20 micrometres in the highly kaolinized material to less than 10 per cent in the slightly

TABLE 4
CHEMICAL ANALYSES OF SECONDARY KAOLIN
SEQUENCE IN BOREHOLE 88-43

Depth (m)	Al ₂ O ₃	Fe ₂ O ₃	SiO ₂	Na ₂ O	K ₂ O	CaO	TiO ₂	MnO	L.O.I.
59-68	17.4	6.6	58.7	1.5	1.6	2.3	0.6	.08	9.6
58-60	18.1	5.3	59.2	0.8	1.4	2.2	0.6	.06	10.3
60-62	23.1	7.9	50.4	0.6	1.0	1.8	0.8	.08	12.9
62-64	29.3	9.8	42.1	0.2	0.4	1.0	1.3	.06	14.9
64-65	25.1	8.7	47.3	0.7	1.0	1.3	1.3	.07	13.4
65-66	23.1	6.8	50.5	0.7	1.3	2.5	0.8	.07	13.8
66-68	27.9	9.7	44.2	0.2	0.8	0.7	1.0	.13	14.3
68-70	29.1	9.8	41.4	0.4	0.6	0.7	1.1	.09	15.0
70-71	28.0	7.6	45.7	0.5	0.7	0.6	0.6	.16	14.0
71-72	17.7	4.8	57.8	0.8	1.4	4.4	0.6	.09	11.3
72-74	28.7	8.4	42.9	0.4	0.7	0.9	1.0	.09	15.4
74-76	25.4	10.2	43.9	0.6	0.8	1.3	1.4	.12	15.1
76-78	15.0	6.5	56.3	0.8	1.3	6.0	0.6	.10	12.5
78-80	18.8	5.6	69.0	0.4	0.8	2.3	0.6	.08	11.8

TABLE 3
RATIONAL ANALYSES OF THE 20 MICROMETRE
FRACTIONS OF THE PRIMARY KAOLIN

Borehole	Depth (m)	Kaolin %	Biotite %	Kaolin %	Illite %	Smectite %	Exchange Capacity (Methylene Blue)
		Allocates K ₂ O & Fe ₂ O ₃ to Biotite		Allocates K ₂ O to Illite & Fe ₂ O ₃ , Mgo to Smectite			
88-13	54-56	83	16	71	28	-	5
	61-63	85	11	66	25	9	N.D.
88-14	33-35	85	15	74	26	-	4
	40-42	90	10	73	23	-	12
88-18	25-27	89	11	58	25	17	-

altered granodiorite. The average recovery for a 60 per cent brightness unbleached product was 25 per cent.

The chemical factors relating to these properties are detailed in Table 2. Mineralogical analysis of the minus 20 micrometre fractions are presented in Table 3.

An investigation of bleaching methods to improve the brightness evaluated oxidative and reductive bleach techniques and the use of high intensity wet magnetic separation. The most effective technique was hot hydrochloric acid which enabled a brightness of 80 per cent (GE) to be achieved. The secondary kaolin was evaluated for its ceramic properties in the research laboratories of The University of British Columbia. Results of analyses are presented in Tables 4 and 5 (Carlson and Chaklader 1988). The data confirms that the clay in places is suitable for use in medium-duty refractory bricks. Some depth intervals also are acceptable as a source of alumina in cement manufacture.

RESERVE CALCULATIONS

THE PRIMARY KAOLIN

Reserve calculations have been based on the recoveries and product qualities obtained from the laboratory investigations. An unbleached brightness value of 50 per cent brightness (GE standards) was defined as a minimum brightness value for resource calculations.

Boundaries were defined by interpolation between boreholes on the basis of the measured thicknesses of

TABLE 5
CERAMIC TEST DATA - SECONDARY KAOLIN
(CARLSON AND CHAKLADER, 1988)

Borehole	Depth	P.C.E. Value	Temperature (degrees celcius)
87-29	30-32 m	Cone 32-33	1717 - 1743
87-29	32-35 -270 # no leaching	Cone 31	1683
87-25	61-63 m	Cone 29	1659

primary kaolin. In locations where borehole data was not available, extrapolation has been constrained to 10 metre horizontally per 3 metre thickness contour.

Geologic reserves were calculated by Kilborn Engineering (B.C.) Ltd. using vertical sections with a section projection distance of 140 metre prepared by Beaty Geological Ltd. Because of environmental constraints introduced by the proximity of the resource to Lang Creek, calculations were made of Mineable Reserves on the basis of an open-pit operation.

Geologic Reserves = 6.0 million metric tonnes.

Mineable Reserves = 4.8 million metric tonnes.

If underground mining was used this mineable reserve tonnage would increase to close to the geologic reserve figure.

THE SECONDARY KAOLIN

No attempt was made to evaluate the extent or reserves of the secondary kaolin. In some exploration drillholes the cyclothem sequence is over 60 metres (200 ft) thick in boreholes 200 metres (200 yds) apart. In the absence of confirmed high price markets for this material, no further delineation of this material has been carried out. With such little drill hole test data it is categorized to be an inferred resource of tens of millions of tonnes.

OVERBURDEN

Glacial till covers the whole Lang Bay basin. It varies from 4 metres (13 ft) thick in a borehole close to Lang Creek to over 45 metres (150 ft) towards the centre of the basin. Much of the primary kaolin also is overlain by variable thicknesses of the cyclothem (secondary kaolin) sequence of basin sediments.

In the calculation of overburden ratios for mine planning, both the glacial till and secondary kaolin sequence were classified as overburden. A slope stability factor of 30 per cent was used to determine an overall overburden ratio of 7.65 tonnes of overburden per tonne of primary kaolin ore.

If underground mining were to be used, the overburden ceases to be a major factor although it will still be necessary to access the primary kaolin by way of declines.

CURRENT STATUS OF THE PROJECT

Discussions are currently being held with various paper companies to investigate the possible use of the primary kaolin as a wood fibre substitute in newsprint manufacture.

Underground mining of the primary kaolin is also under consideration because of the very large amount of overburden which would have to be removed in any opencast operation.

The economics of mining the secondary kaolin as a refractory raw material or a source of alumina in cement manufacture are not attractive at this time because of the high overburden ratios. However, if the primary kaolin were to be mined by underground mining methods then these economics might become favourable.

REFERENCES

- Carlson, R. and Chaklader, A.C.D. (1988): Investigations of the Brown Bed Clay of the Lang Bay Deposit; *Department of Metals & Material Engineering, The University of British Columbia*, unpublished report.
- Harvey, C.C. (1988): Geology of the Lang Bay Kaolin Prospect, British Columbia, Canada; KRTA Ltd., Report to Fargo Resources Ltd. and Brenda Mines Ltd.
- Ionides, G.N. (1991): Opportunities for high value-added paper making pigments in Western North America; *Proceedings, 27th Forum on the Geology of Industrial Minerals*, this volume.
- Mak, S. and Chaklader, A.D.C. (1987): Investigation on the kaolin at the Lang Bay prospect; *Department of Metals and Material Engineering, The University of British Columbia*, unpublished report.
- Skerril, A.C. (1959): Report on the germanium property of Taiga Mines Ltd., Lang Creek Powell River area, British Columbia; Private report to Taiga Mines Ltd.
- White, G.V. (1986): Lang Bay Germanium Prospect (92F/1610); *Ministry of Energy, Mines and Petroleum Resources of British Columbia, Geological Field Work 1985, Paper 1986-1, Preliminary Report*.

OPPORTUNITIES FOR HIGH VALUE-ADDED PAPERMAKING MINERAL PIGMENTS IN WESTERN NORTH AMERICA

By George Ionides

Temalex Consulting Inc., North Vancouver, B.C.

INTRODUCTION

The paper industry in western North America is large and vital. The region accounts for about 25 per cent of total North American paper consumption. British Columbia's pulp and paper industry is strongly dependent on this region. Through the years, this regional paper industry has remained at a disadvantage relative to the rest of North America due to the lack of local papermaking mineral pigments. These pigments have traditionally originated in the southern U.S.A., which is the source of high quality mineral pigment deposits. Although the western region is largely self-sufficient in paper grades which traditionally have not utilized mineral pigments, it is in general deficient in pigmented grades.

We believe that a major reason for this is the significant transport cost penalty to deliver suitable mineral pigments to Western North America. We further believe that this creates opportunities both for the minerals and paper industries in Western Canada.

This paper presents a basic analysis and summary of the Western North American paper industry, its mineral pigments requirements and trends, and potential opportunities and constraints in developing a local papermaking mineral pigments industry. Relatively small amounts of pigments are used in packaging paper grades, and virtually none in tissue products, so we exclude them in this discussion and concentrate on the printing grades, some of which use substantial amounts of mineral pigments. Another reason for placing special emphasis on these "information" grades is that they have exhibited roughly double the demand growth which the tissue and

packaging grades have in the last 10 to 15 years, and this situation is expected to continue in the 1990s.

THE WESTERN NORTH AMERICAN AND WESTERN CANADIAN PAPER INDUSTRY

SELF-SUFFICIENCY

Western North America is defined here as the area of the United States and Canada west of the Rocky Mountains, and in many ways it represents a region that can be analyzed independently of the rest of the continent. It roughly represents about 20 to 25 per cent of North American population and economic activity. The region is quite self-sufficient in non-pigmented papers, such as newsprint, but deficient in pigmented papers, as shown in Table 1 below.

Clearly, the regional self-sufficiency is quite low in pigmented grades. Furthermore, in the case of coated grades, regional utilization is about half of what the population and economic share of western North America would imply.

NORTH AMERICAN PAPERMAKING MINERAL PIGMENTS INDUSTRY AND MARKETS

PAPERMAKING MINERAL PIGMENTS - GENERAL BACKGROUND

Papermaking mineral pigments are utilized in the manufacture of paper primarily to impart functional properties to sheets of paper which cannot be obtained

TABLE 1
THE WESTERN NORTH AMERICAN PRINTING PAPERS INDUSTRY

a) CONSUMPTION

GRADE	% PIGMENT	MAIN END USES	% OF NORTH AMERICAN DEMAND
NEWSPRINT	0-3	Newspapers	20-25
UWF*	10-20	Business	20-25
COATED	25-30	Magazines	10-12

b) PRODUCTION AND SELF-SUFFICIENCY

GRADE	% PIGMENT	SELF-SUFFICIENCY (% Demand/Production)
NEWSPRINT	0-3	90-100
UWF*	10-20	40-45
COATED	25-30	20-25

* Uncoated woodfree (uncoated but mineral filled) business papers.

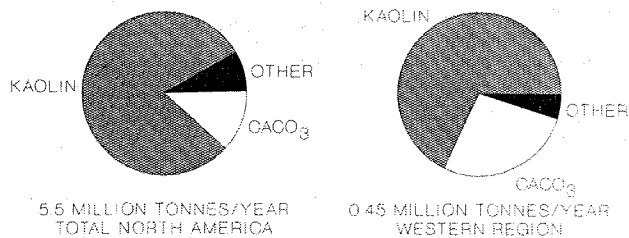

Figure 1. North American papermaking mineral pigments consumption (1989-1990 estimates).

from wood pulp alone. These are primarily optical (brightness, opacity, gloss) and printing (contrast, print gloss, low show through) properties. Only the purest and brightest of pigments are suitable for papermaking.

There is another, less widespread usage in North America, but more evident in areas which lack forest resources, namely as a lower cost substitute for wood pulp in paper products.

There are two major end uses for mineral pigments in paper manufacture, namely:

-Filler in uncoated papers: In this application, the pigment is mixed with wood fibres and is therefore found throughout the thickness of the paper. Uncoated woodfree photocopy papers are typical examples.

-Coating on coated papers: In this application, the pigment is applied to a wood fibre substrate, just like peanut butter to bread. Lightweight coated papers, such as are used to print TIME magazine, are typical examples.

THE NORTH AMERICAN PAPERMAKING PIGMENTS MARKET

The North American papermaking mineral pigments industry is by far the largest in the world, accounting for over 40 per cent of global consumption and production. This industry has experienced healthy demand growth in the last 10 to 15 years as a result of supplying the needs of the relatively rapidly growing demand from the "information" papers sector.

Figures 1 and 2 show the breakdown of papermaking mineral pigments in North America and the western region's share. Figure 1, shows that kaolin accounts for the largest market share, although (precipitated) calcium

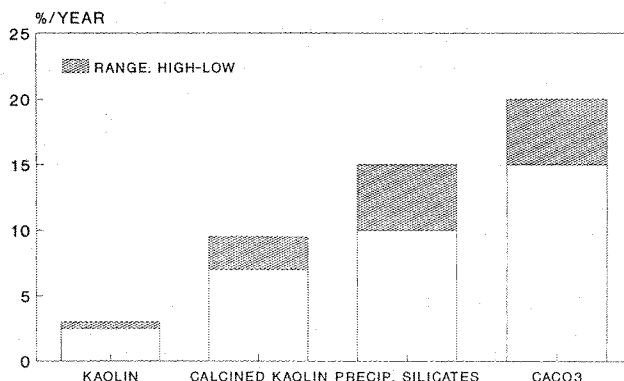

Figure 2. Projected growth rates in papermaking mineral pigments consumption 1989-93 in North America.

carbonate has been growing at a higher rate in the last few years on account of economic and performance considerations. The availability of high quality (purest, brightest) kaolin deposits in the southern United States explains why the papermaking pigments industry is so heavily concentrated in this region, and why this mineral dominates the papermaking pigments market.

Its geographical origin, of course, increases considerably the cost of kaolin to those regions of the North American continent which are distant from the southern U.S.A. Table 2 shows some typical papermaking kaolin grade prices and estimated transportation costs to various regions. It is seen that for some of the lowest quality filler grades transportation accounts for more than 50 per cent of the delivered cost to British Columbia's pulp and paper mills.

The incremental cost of about \$100 per tonne of kaolin for British Columbia translates into an incremental cost per tonne of paper of about \$20 at a sheet loading of 20 per cent. For a world class paper machine with a capacity around 200 000 tonnes per year, this represents a \$4 000 000 disadvantage for a B.C. paper machine against a southern U.S.A. machine. Clearly, this is a major reason why there is a strong need to seek and develop local papermaking mineral pigments in Western Canada.

TABLE 2
DELIVERED COSTS OF KAOLIN ORIGINATING IN THE SOUTHERN U.S.A. TO VARIOUS NORTH AMERICAN REGIONS

KAOLIN GRADE	DESTINATION	KAOLIN COST+ (\$/ton)	TRANSPORT COST (\$/ton)	TOTAL COST (\$/ton)
AF*	Southern U.S.A.	60	10-20	70-80
	B.C.	60	110-130	170-190
WW++	Southern U.S.A.	150	10-20	160-170
	B.C.	150	110-130	260-280
CALCINED	Southern U.S.A.	500	20-30	520-530
	B.C.	500	130-150	630-650

+ Wide range for numerous grades; a typical cost quoted here;

* Air-Float;

++ Water-Washed

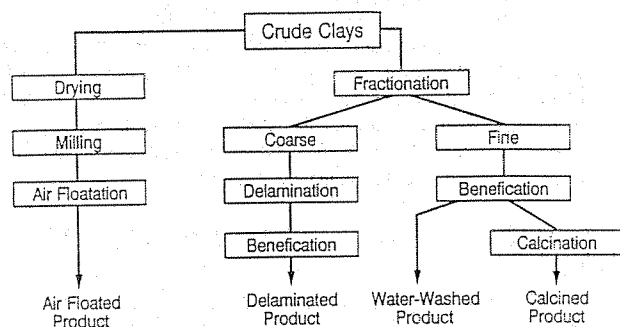

Figure 3. Kaolin processing.

PAPERMAKING MINERAL PIGMENTS ARE HIGH VALUE-ADDED PRODUCTS

As seen in Table 2, papermaking pigments are high value-added products, compared to the raw ore cost of about \$5 to \$10 per tonne. As such, they provide significant potential for maximizing the value of the mineral resource. This is a second important reason why there should be a strong interest in developing a local papermaking mineral pigments industry. Western Canada's rich and diverse mineral natural resource is a major advantage for such a development.

MAJOR PAPERMAKING PIGMENTS

There are three primary papermaking mineral pigments; namely;

- Kaolin,
- Calcium carbonate (two grades: ground and precipitated),
- Titanium dioxide.

A fourth pigment worth mentioning is talc. Although its natural hydrophobic nature makes it difficult to use in papermaking, it has been used successfully in some countries, such as Finland. Talc has a special role in the pulp and paper mill, however, as a pitch control agent, and it is used in many pulp and paper mills for this purpose.

In addition, there are a number of specialty pigments, including barium sulphate, gypsum and others whose consumption tonnage and market share is not significant. We will briefly review the basic manufactur-

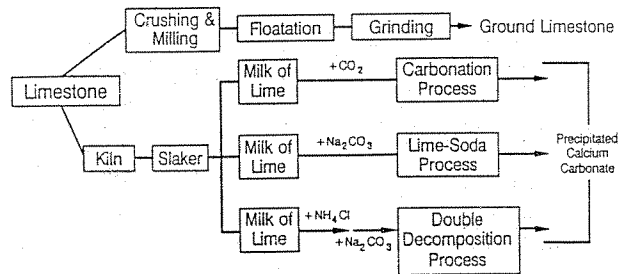

Figure 4. Calcium carbonate processing.

ing processes of these pigments and their primary performance properties.

KAOLIN

As mentioned previously, kaolin has the largest market share of papermaking mineral pigments, at about 70 to 75 per cent of total market tonnage. After extraction from the ground, the raw ore undergoes processing to produce a variety of grades (see Figure 3). The four major grades are Air-float, Water-washed, Delaminated, and Calcined. Although there are some basic similarities, these major grades have different characteristics which make them especially suited for specific end uses.

CALCIUM CARBONATE

There are two distinct types of calcium carbonate used in papermaking, *ground* and *precipitated*. Figure 4 shows schematically how they are produced.

The ground calcium carbonate is produced in much the same way that kaolin is processed. The most outstanding growth rate of all pigments in the last few years, however, has been exhibited by precipitated calcium carbonate. The driving forces have been both economic and technological. This product is produced by precipitation from a solution, and therefore can be obtained in very pure form.

It should be noted that calcium carbonate is soluble at acid pH less than 7. As a result, its growth rate had been inhibited by the fact that most papers, until very recently, were produced under acid papermaking conditions. This has been changing (again for economic and technological reasons) in the last few years, and many

TABLE 3
PAPERMAKING MINERALS PIGMENT QUALITY

	BRIGHTNESS %	VALLEY ABRASION mg	PARTICLE SIZE % < 2 micron	SPECIFIC SURFACE m ² /gr
KAOLIN				
AIR-FLOAT	80-82	N/A	50-95	10-15
WATER-WASHED	83-86	5-20	50-95	12-20
DELAMINATED	87-89	5-20	N/A	12-20
CALCINED	90-93	20-40	80-90	12-20
CALCIUM CARBONATE				
GROUND	94-97	20-30	50-70	5-10
PRECIPITATED	94-97	20-30	60-90	8-10
TITANIUM DIOXIDE	95-96	> 50	97-99	10-30

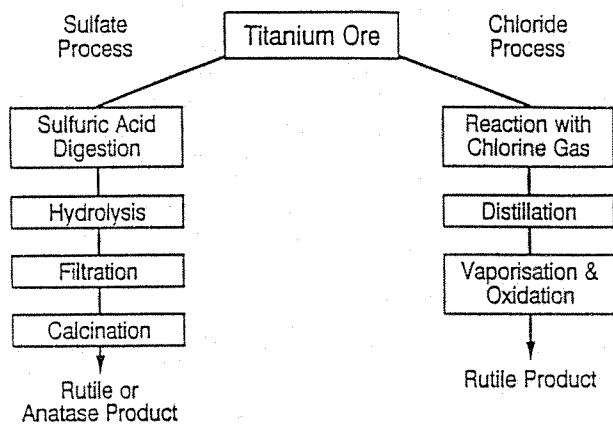

Figure 5. Titanium dioxide production.

papers are now made under neutral or alkaline pH conditions. However, there are many grades which cannot be made under alkaline conditions without paper quality problems. These must still rely on kaolin or other pigments.

TITANIUM DIOXIDE

Titanium dioxide is the brightest and most opacifying pigment. Its widespread usage, however, is strongly inhibited by its very high price, roughly 10 times that of conventional kaolin and calcium carbonate, and 4 to 5 times that of calcined kaolin. Titanium dioxide is also made by a chemical reaction process, as illustrated in Figure 5.

PIGMENT QUALITY

The most important performance properties of papermaking mineral pigments are brightness, particle size distribution and abrasiveness. The last one must be as low as possible to minimize damage to paper machine components. Table 3 summarizes basic properties of some major papermaking pigments.

COMMERCIAL DEVELOPMENT CASE STUDY

Responding to the needs of the Western Canadian paper industry, Fargo Resources Ltd. is currently developing its Lang Bay, B.C. kaolin mine for commercial operation. Initially, lower quality grades, easier to produce and market (and the most sensitive to transport costs), will be produced followed ultimately by higher quality grades, possibly including calcined ones.

THE GEOLOGY OF SANDS AND GRAVELS IN THE BOW VALLEY CORRIDOR, ALBERTA

By W. A. Dixon Edwards

Alberta Geological Survey, Edmonton, Alberta

ABSTRACT

The major sources of sand and gravel in Alberta can be divided into three general geological categories: preglacial, glacially-derived and alluvial deposits. Outwash or kame terraces are almost the sole source in the Bow Valley (Banff National Park boundary to Seebe): there are no preglacial deposits in the valley and the Bow River is not used as a gravel resource. The Canmore terrace is part of a very well displayed terrace system on the north side of the Bow Valley between Harvie Heights and Gap.

The Canmore terrace (or valley train) sands and gravels are a thick sequence of granular sediments below the Canmore till. The terrace sediments are over 300 feet (90 m) thick with up to 80 feet (24 m) of material exposed at any one section. The stratigraphy (base to top) is interpreted as glaciolacustrine deposits ponded in the valley when the Canmore glacier was far removed up the valley, covered by sands turning to gravels as the Canmore glacier advanced, changing to poorly-sorted outwash as the ice assumes a proximal position and finally, topping the sequence, a till deposited as the glacier overrode the entire sequence.

Burnco Rock Products Ltd. operates a sand and

TABLE 1
ESTIMATED OCCURRENCE AND SOURCES OF PRODUCTION OF SAND AND GRAVEL IN ALBERTA IN 1988

	Occurrence	Production
Preglacial	20%	25%
Glacially derived	70%	30%
Recent, alluvial	10%	45%
Total	45 x 10 ⁹ tonnes	42 x 10 ⁶ tonnes

gravel pit (Canmore pit) 3 miles (5 km) southeast of the town of Canmore. It is located in the outwash and ice-proximal outwash of the Canmore terrace. The pit has been open for over 20 years with Burnco operating it since 1975. The material from this pit is described as high quality, suitable for concrete and asphalt mixes. Overburden varies from 20 to 50 feet (6 to 15 m) but with a sand and gravel face of over 100 feet it makes moving this amount of overburden feasible. The superior quality and close proximity to the growing Canmore/Banff market makes this a unique and vital resource.

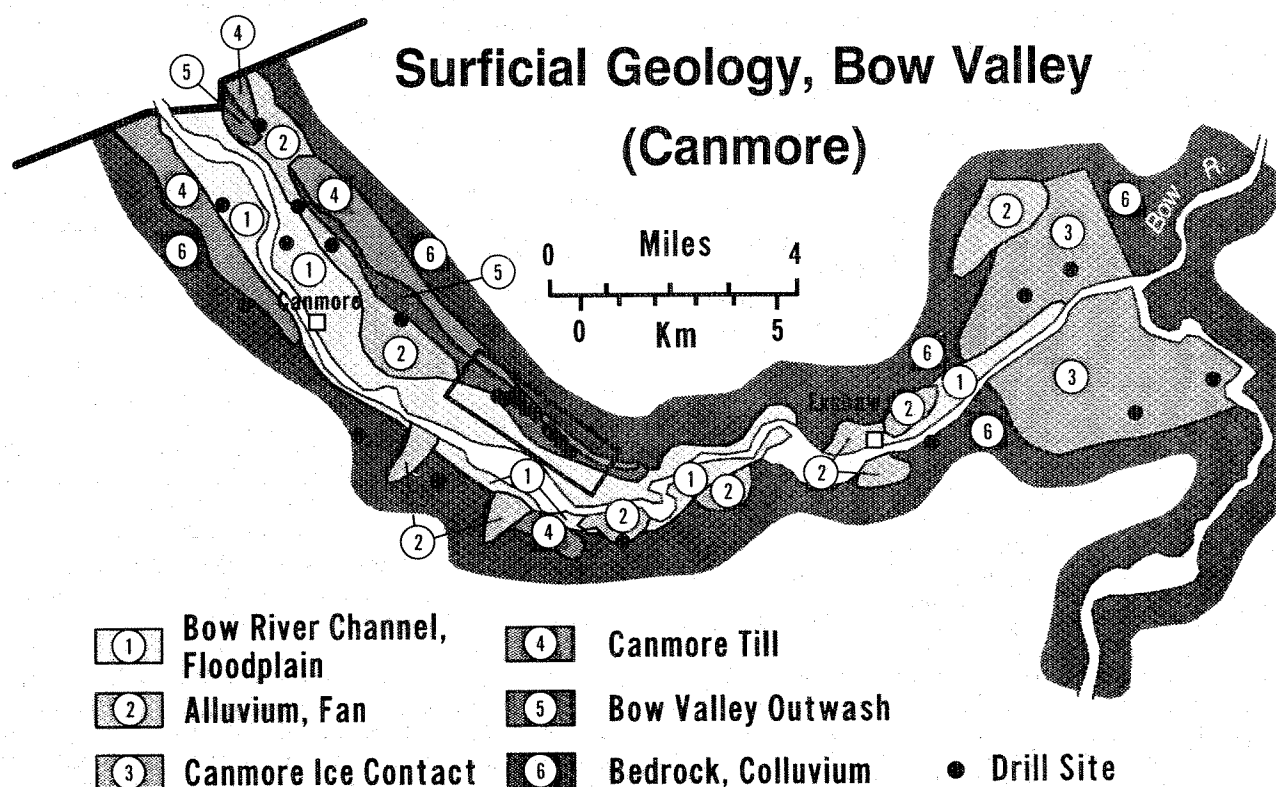

Figure 1. Simplified surficial geology map of the Bow Valley (Canmore) (modified from Edwards, 1979).

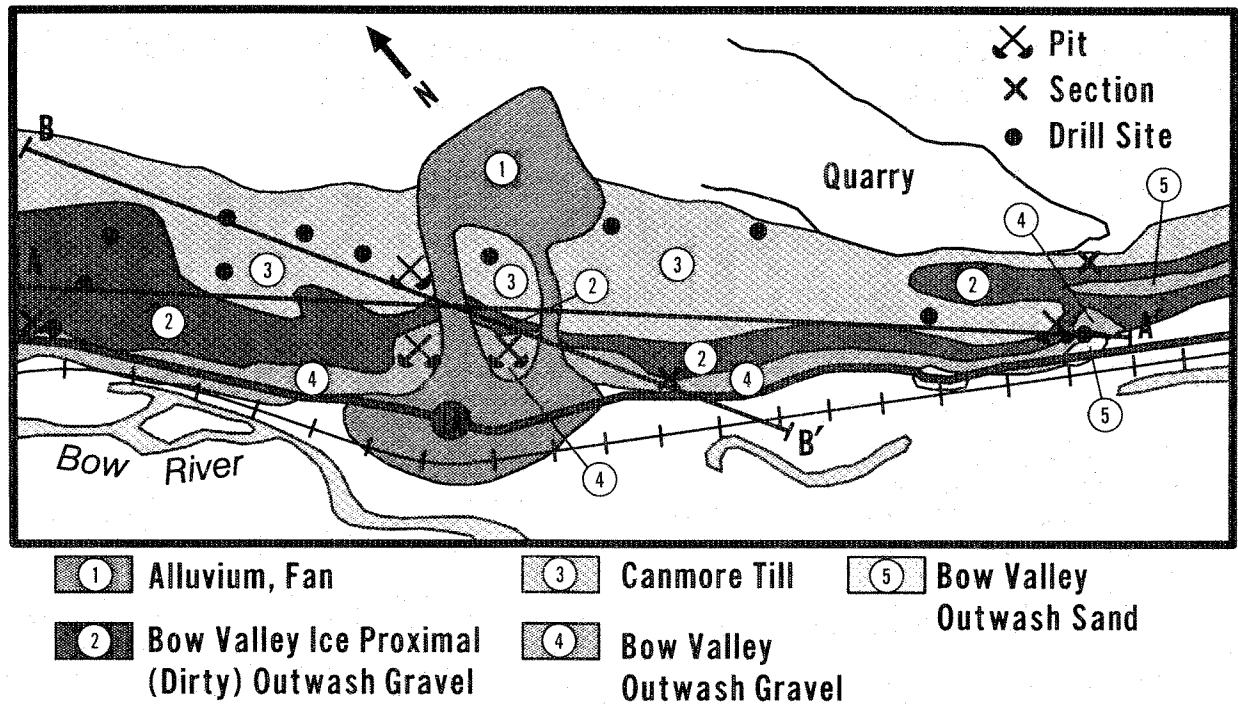

Figure 2. Simplified surficial geology map of the Canmore terrace (modified from Edwards, 1979).

THE GEOLOGY OF SANDS AND GRAVELS IN THE BOW VALLEY CORRIDOR, ALBERTA

SAND AND GRAVELS IN ALBERTA

In 1988 Alberta mined about 42 million tonnes of sand and gravel (Vagt, 1989). This makes Alberta the second largest provincial producer of sand and gravel in Canada. The Alberta Geological Survey has been mapping sand and gravel for many years throughout the province and to date has identified about 45 billion tonnes.

The major sources of sand and gravel in Alberta can be divided into three general geological categories: preglacial, glacially-derived and alluvial deposits (Table 1).

Preglacial deposits represent a high quality source of gravels, especially for the major cities of Calgary and Edmonton. The preglacial deposits were formed by rivers flowing from the mountains across the plains before continental glaciation. The oldest deposits (Cypress Hills Formation, Hand Hills Formation, gravels on the Swan Hills, Del Bonita Uplands, Pelican Mountains, Halverston Ridge and Caribou Mountains) are probably early Tertiary (Eocene) to late Tertiary (Pliocene) in age. These older preglacial sands and gravels are the also the highest in elevation. The youngest of the preglacial sands and gravels are Quaternary in age and are at or below present prairie level (exposed at Villeneuve, Grimshaw and along the Simonette, North Saskatchewan, South Saskatchewan and Oldman Rivers) (Edwards, 1988). In the Calgary region Nose and Broadcast Hills are covered by preglacial sands and gravels and further west the Crawford and Radnor Plateaux were probably carved by a preglacial river. Within the Bow Valley between the Banff National Park boundary and Seebe there are no preglacial sands and gravels.

Glacial-derived deposits provide a widespread and very important source of sands and gravels in Alberta. An estimate of total aggregate resources (Table 1) is that the glacially derived deposits (outwash, ice-contact and melt-water channel) are by far the largest potential source in the province. Several types of glacially-derived deposits occur in the Bow Valley: outwash, valley train or kame terrace, esker and kame.

Alluvial deposits produce a large volume of material but are becoming a more restricted source of aggregate, especially deposits at or below river level. Alluvial deposits are present along the Bow River in the Canmore area but are not used as aggregate sources. Alluvial fans along the valley sides are a much poorer source of aggregate materials but are occasionally used.

GENERAL GEOLOGICAL HISTORY OF THE BOW VALLEY

The Bow Valley between Banff National Park and the Gap is eroded along the Mt. Allan Syncline. The valley in this area is wide and contains outwash terraces on both sides. The terraces on the northeast side of the valley are the best developed and exposed. Terraces to the east of Canmore are the main supply of gravel for the region and are described in detail (Edwards, 1979).

The lower part of the Bow Valley, between Gap and Kananaskis, cuts across the structural trend and is a much narrower feature without terraces.

Figure 1 is a simplified surficial geology map of the Bow Valley from the Banff National Park boundary to Seebe (Edwards, 1979). All surface units were formed during the last or Canmore glacial advance or by recent alluvial action. From oldest to youngest these units are (Figure 1): outwash sand, outwash sand and gravel and ice-proximal outwash gravel (unit 5), till (unit 4), ice-con-

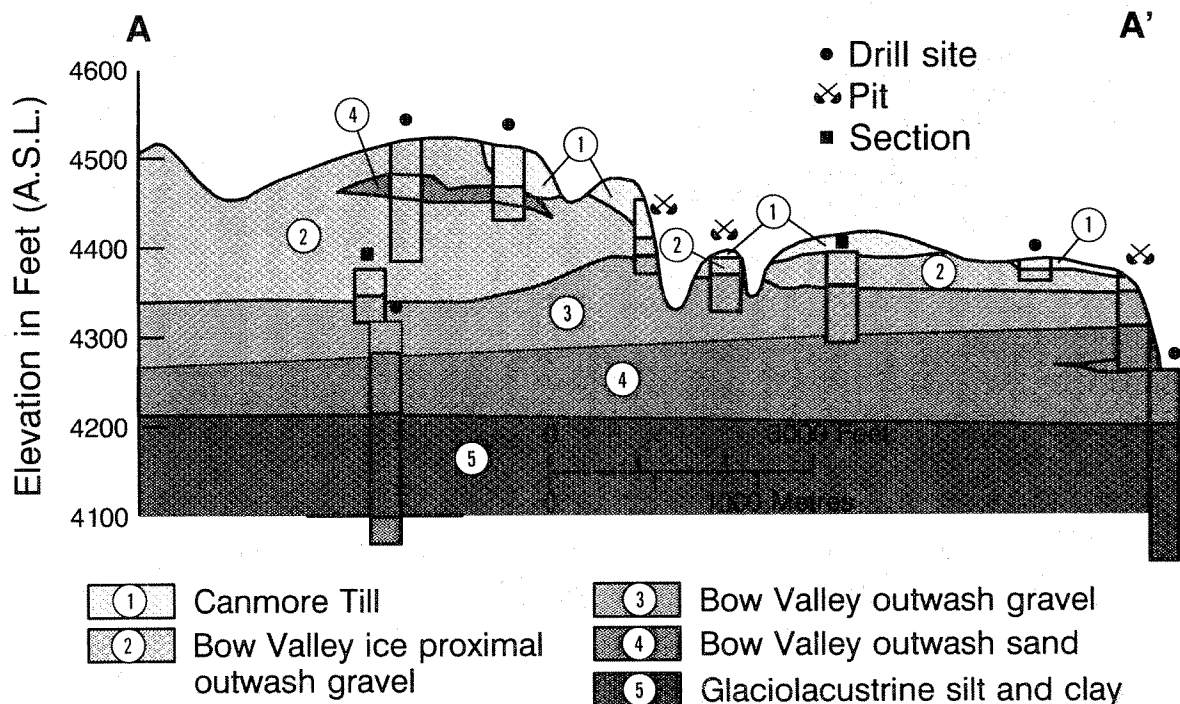

Figure 3. Cross section A-A' (from Figure 2) along the Canmore terrace (modified from Edwards, 1979).

tact and outwash deposits (unit 3), alluvial fans (unit 2) and Bow River deposits (unit 1).

Just outside the Bow Valley a drumlin field is found on Morley Flats. Ice flow was from west to east, out of the Bow Valley. These drumlins were formed by an older alpine advance, the Bow Valley advance. The Canmore glacier did not reach the area of these drumlins but surrounded them with sands and gravels as it washed away from the terminal position near the Kananaskis River (Proudfoot et al, 1981).

Figure 1 shows some of the areas where till deposited during the Canmore advance is preserved. In general this is on the valley sides above outwash or on bedrock where the Bow River has not eroded it away.

The Canmore glacier reached the end of corridor (Seebe area) and at the terminus formed ice-contact features. These include outwash, kames, kettles and eskers. Gravel pits are developed in both the kame deposits and the adjacent outwash.

Following the retreat of the Canmore glacier, the Bow River became established in the valley eroding away much of the valley fill outwash and till. Alluvial fans formed from small and intermittent streams issuing from gullies and canyons on the valley sides. These dissected the outwash and till and has produced excellent exposures of these units. A number of the fans were penetrated with a rotary drill. The fans varied in thickness from 10 feet (3 m) to over 50 feet (15 m) depending on the size (area) of the fan and the location of the hole. The fans are poorly sorted, ranging from thin silt beds to boulders. They are a poor source of gravel but have been used for rip rap.

The principal gravel pit in the region is operated by Burnco Rock Products Limited. The pit is located in the

Canmore terrace below Grotto Mountain and under the Continental Lime Ltd. limestone quarry. The Canmore terrace (Figure 2 and inset area on Figure 1) has been the subject of detailed study and much economic and stratigraphic detail is available.

GEOLOGY OF THE CANMORE TERRACE

SOURCES OF DATA

The Alberta Geological Survey during the course of sand and gravel exploration placed 12 rotary drill holes on or in front of the Canmore terrace in 1976 (Edwards, 1979). In 1982 another 3 hammer drill holes were placed on the top of the southeastern end of the terrace (Edwards, 1982). Numerous natural sections and gravel excavations were also present during mapping in 1976 and 1982. These are the primary sources of information for the stratigraphy of the Canmore terrace (Figure 2) which follows.

GLACIOLACUSTRINE SILTS AND FINE SANDS

A 231 foot (69 m) hole was drilled from the base of a 65 foot (19 m) natural section on the northwestern end of the terrace (unit 5 on Figure 3). The hole did not hit bedrock or till. The lower part of the hole logged over 100 feet (30 m) of fine sands and silts. At the southeastern end of the terrace another hole penetrated 169 feet (51 m) of the same fine-grained sediments (Edwards, 1979). These silts and sands are interpreted as glaciolacustrine, deposited in a bedrock depression in the valley when the glacier was far up valley, perhaps near Banff. This unit is not exposed at the surface.

OUTWASH SANDS

Above the silt-fine sand unit is a unit of medium to coarse sand 50 to 100 feet (15 to 30 m) thick (unit 4 on

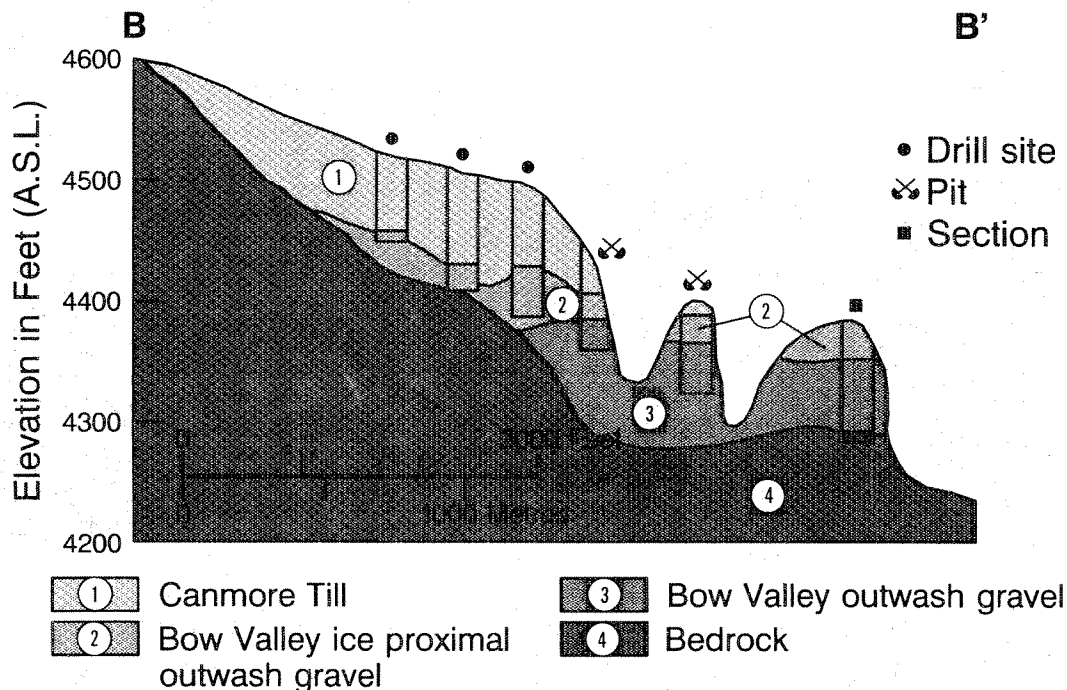

Figure 4. Cross section B-B' (from Figure 2) across the Canmore terrace (modified from Edwards, 1979).

Figures 3 and 4; Edwards, 1979). At the southeastern end of the terrace the upper part of this sand unit outcrops. At this stratigraphic position it is medium to coarse sand interbedded with pebbly sand. The unit is interpreted as outwash sand, deposited as the Canmore glacier began advancing.

OUTWASH GRAVEL

Visible along the edge of the terrace are clean, well sorted gravel beds (unit 3 on Figures 3 and 4). The unit is 20 to 80 feet (6 to 24 m) in thickness and is the primary unit mined at the Burnco Rock Products Ltd. operation.

Pebbles average 1 to 2 inches (25 to 50 mm) in size and are generally well-rounded. The roundness indicates there was some considerable distance of fluvial transport. Planar cross-beds 6 to 24 inches (150 to 600 mm) thick indicate a flow direction parallel to and slightly away from the valley side (Edwards, 1979).

The unit is interpreted as outwash gravel, formed as the Canmore glacier continued to advance towards the site.

ICE PROXIMAL (DIRTY) OUTWASH GRAVEL

Above the (clean) outwash gravel is a more poorly sorted gravel unit, 20 to over 100 feet (6 to 30 m) in thickness (unit 2 on Figures 3 and 4). The unit contains up to 10 per cent cobble size clasts and 20 per cent fines. Pebbles are sub-rounded (Edwards, 1979). The fines are often washed out of the unit and run down the face obscuring the beds.

The unit is interpreted as ice-proximal outwash, deposited as the Canmore glacier was very close to the site. This dirty outwash can be misinterpreted from a distance as till because the beds are indistinct and the unit contains cobble-size material.

Hoodoos can be seen standing guard over the Canmore cemetery from Highway 1 as you pass Canmore.

The hoodoos are formed of poorly sorted gravel with cobbles. The hoodoos occur in the upper part of terrace face; correlative with the ice-proximal outwash unit. They are very durable. Compared with photographs taken over 100 years ago, they show virtually no change.

CANMORE TILL

A diamicton (unit 1 on Figures 3 and 4) was drilled in all eleven holes spotted on the top of the Canmore terrace (Figure 2; Edwards, 1979 and 1982). It can also be mapped along the north side of the valley at least as far as the Banff National Park boundary (except for zones cut by recent alluvial fans) (Figure 1).

The unit rests both on the outwash and bedrock (Figure 4). Where it rests on bedrock, the limestone is usually polished and striated. The contact with the dirty outwash unit is very indistinct. The diamicton is very stony and sandy, pebbles are sub-angular to sub-rounded and commonly shaped, polished and striated (Edwards, 1979).

The unit is interpreted as a till which was deposited by the Canmore glacier as it advanced over the outwash or limestone. The till is found at even the highest levels of the Continental Lime Ltd. quarry (level 27) and thus the ice was at least 750 feet (225 m) thick above present.

OVERALL STRATIGRAPHY

The complete stratigraphy of the Canmore terrace is shown in Figure 3. Overall the sequence is interpreted as displaying:

1. a coarsening upward sequence: from silt (glaciolacustrine) to sand (outwash) through gravel (outwash) to cobbly gravel (ice-proximal outwash) to bouldery diamicton (till).

2. a change in environment: from still water (glaciolacustrine) to fluvial conditions (outwash) and finally to a glacial environment.

3. a decrease in distance of fluvial transport as interpreted from the decrease in pebble roundness upwards: from well-rounded pebbles in the outwash gravel to sub-rounded pebbles in the ice-proximal outwash and finally to sub-angular clasts in the till.

4. a record of the advance of the Canmore glacier: based on the evidence from statements 1 to 3 above plus the decrease in sorting upwards from well-sorted sand and gravel in lower sequence to poorly sorted outwash and then into till (unsorted).

SAND AND GRAVEL EXTRACTION

The major sand and gravel pit in the Canmore terrace is located at about the mid point of the terrace (longitudinally) and along the edge. The pit has been operating for over 20 years. Burnco Rock Products Ltd. has operated the pit since 1975.

The material is high quality, suitable for concrete and asphalt mixes. Overburden varies from 20 to 50 feet (6 to 15 m) but with a sand and gravel face of over 100 feet (30 m) it makes moving this amount of overburden feasible. The superior quality and close proximity to the growing Canmore-Banff market makes the Canmore pit a unique and vital resource.

The land for the pit is leased from the Crown for long-term sand and gravel extraction. In 1985 Burnco Rock Products Ltd. in conjunction with the town Canmore looked into the feasibility of using the mined-out pit as a clean-waste disposal site. The proposal was approved by the provincial government and will allow Burnco Rock Products Ltd. to continue mining while creating an unobtrusive excavation for the expanding clean waste demands of the region (personnel communication, Scott Burns).

REFERENCES

Edwards, W. A. D. (1979): Sand and gravel deposits in the Canmore Corridor area, Alberta; *Alberta Research Council Earth Science*, Report 79-2, 30 pages.

Edwards, W. A. D. (1982): Evaluation of granular deposits in the Canmore Corridor terraces; *Alberta Geological Survey*, internal report.

Edwards, Dixon (1988): Tertiary gravel deposits of Alberta; Alberta Geological Survey Research Forum Program Presentation and Poster, Calgary, November 8, 1988.

personnel communication: Scott Burns of Burnco Rock Products Ltd.

Proudfoot, D. N., Moran, S. R. and Rutter, N. W. (1981): The Quaternary stratigraphy and geomorphology of southwest/central Alberta; in Field Guides to Geology and Mineral Deposits, Thompson, R. I. and Cook, D. G., *1981 Geological Assoc. of Canada Annual General Meeting*, Calgary, 1981, pages 225-260.

Vagt, O. (1989): Mineral aggregates; in Canadian Minerals Yearbook, *Energy, Mines and Resources*, Mineral Report No. 38.

THE UPPER DEVONIAN PALLISER FORMATION IN THE TYPE AREA NEAR EXSHAW, ALBERTA

By N.C. Meijer Drees

*Institute of Sedimentary and Petroleum Geology,
Calgary, Alberta*

D.I. Johnston

University of Alberta, Edmonton, Alberta

ABSTRACT

A 298.5 metre thick, composite section of the Palliser Formation near Exshaw includes 5 units. It was sampled for conodonts and correlated with incomplete sections near Canmore and Lake Minnewanka. The basal, dark grey dolostone of unit 1 did not yield conodonts, but the dolomitic limestone of unit 2 includes conodonts of the Famennian, Lower to Upper *crepida* zones. The peloidal limestones of unit 3 contain conodonts of the Lower *rhomboidea* to Lower *marginifera* zones. Unit 4 did not yield diagnostic conodonts. The fossiliferous limestones of unit 5 include conodonts of the *praesulcata* zones.

It appears that the interbedded dolostones, carbonate breccia, laminated and silty limestones and stromatolitic limestones of unit 4 represent the lower part of the Costigan member and correlate with the anhydritic deposits of the upper part of the Wabamun Formation in the Gap Lake 6-4-24-7W5 well. The fossiliferous beds of unit 5 represent the upper part of the Costigan member and correlate with the Big Valley member of the Wabamun Formation. Because unit 4 and the Big Valley include conodonts of the same zone as found in the overlying dark shales of the subsurface Exshaw Formation, it is assumed that the sharp contact between the Palliser and the Exshaw Formations does not represent a major unconformity.

THE BEARBERRY ULTRA SOUR GAS PROJECT

By Paul Kitzan and Louis Auger

Shell Canada Limited,
Calgary, Alberta

INTRODUCTION

A demonstration project located in the Bearberry area north-west of Sundre, Alberta (Figure 1) has commenced operations to recover sulphur from gas reserves containing 90 per cent hydrogen sulphide (H_2S) with approximately 80 grams of dissolved elemental sulphur (S) per cubic metre of gas (5000 lbs/MMSCF). As outlined in the application to the Alberta Energy Resources Conservation Board, the objective of the Bearberry Demonstration Project is to establish the technical and economic feasibility of production from the ultra sour H_2S/S Bearberry reserve. Reservoir producibility and production system capability will also be confirmed during the operation of these facilities. Two existing wells were recompleted for production through a new gathering system to a new processing facility. Shell Canada is the operator on behalf of itself, Mobil Oil Canada, PanCanadian Petroleum and Norcen Resources. An op-

erating life of up to five years is expected for the demonstration project. The capital cost of the project is \$55 million, and the annual operating costs are estimated at \$9 million.

SULPHUR MARKET

The Bearberry field was discovered in the late 1960s. A lengthy period of Western World sulphur oversupply and low prices prevailed during the 1960s and 1970s. During this period the industry in Alberta stockpiled some 20 million tonnes of excess sulphur. Demand in the Western World surpassed supply in the late 1970s and the sulphur stockpiles in Alberta became a potential discretionary supply source.

The generally tight supply situation post-1979 encouraged the industry to remelt significant quantities of stockpiled sulphur to balance Western World demand and supply. Annual sales of sulphur from western Canada exceeded 8 million tonnes for a number of years due to world-wide growth in demand primarily for use in fertilizer. Alberta became the major supplier of sulphur traded internationally with a combined supply from current production and remelt.

Alberta's established sulphur market position is now threatened because of the expected decline in future sulphur supply. Inventories are forecast to be depleted in the early 1990s and conventional sour gas sulphur production sources will be in decline in the late 1990s. Unless significant new sources of supply are developed, Alberta's position in the international market will diminish. Development of the Bearberry resource is therefore timely to help maintain Alberta's world sulphur position, and to enhance Canada's export trade balance.

GEOLOGY AND RESERVES

The Bearberry accumulation exists in a porous Devonian Leduc reef which lies at a depth of about 4 000 metres (Figures 2 and 3). The Leduc is underlain by the Cooking Lake platform with no clear separation of the formations. The Beaverhill Lake group is the first unit below the reef with sufficient lithologic (limestone and dolomite) contrast to be identified. The Duvernay and Ireton formations are laterally equivalent to the Leduc in the off-reef position. The Ireton, which in this area is argillaceous (clayey) carbonate, also forms a thin cap on the Leduc on the "near edge" parts of the reef. In the reef interior, the reef appears to build up through the Leduc into the Nisku formation which usually overlies the Ireton.

The Bearberry structure lies on the eastern edge of the disturbed belt. The Mesozoic (shallow) section is structurally complicated by thrust faulting and folding in the southwest part of the area. The Paleozoic (deep) section is not involved in this deformation and the dom-

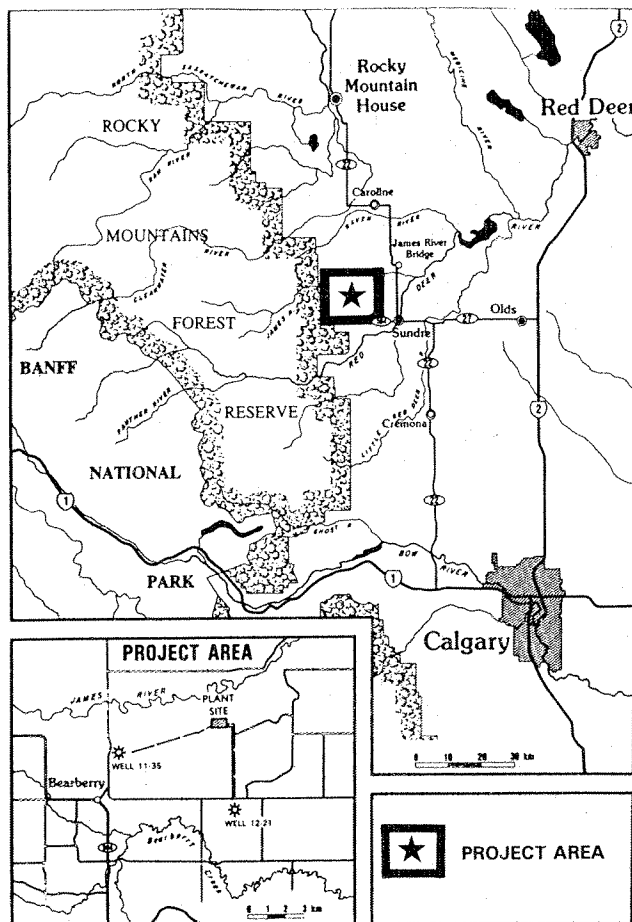

Figure 1. Overall location map.

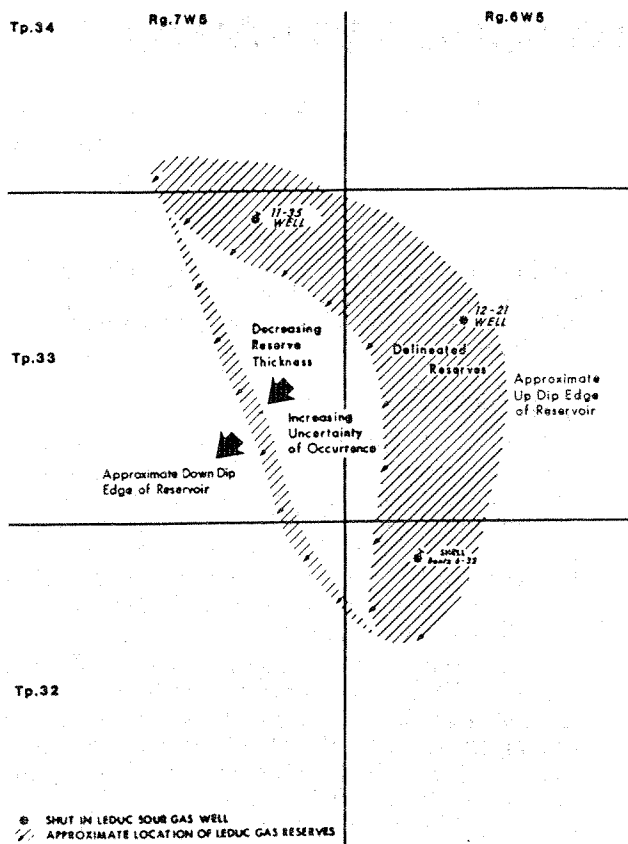

Figure 2. Reservoir development.

inant structural feature is planar regional dip to the west-southwest at a rate of 25 to 30 metres per kilometre.

The porous and permeable Leduc reef terminates in the up-dip direction against impermeable Ireton and Duvernay argillaceous carbonates. The reef edge trends obliquely down-dip in both longitudinal directions. This stratigraphic/structural configuration forms an effective trap to contain the accumulation. Poorer reservoir quality in combination with lower structural elevation results in higher water saturation (but no defined water level) to the southwest.

The original in-place reserves for the Bearberry structure are estimated to be between 60 to 90 billion cubic metres of gas which is equivalent to 70 to 100 million tonnes of sulphur. Wellbore inflow behaviour and expected recovery factor for this field are unknown and their determination is one of the prime objectives of the Bearberry Demonstration Project.

RESERVOIR PERFORMANCE

There are three wells currently drilled in the Bearberry reservoir, they are located in LSD 12-21-33-6W5, LSD 11-35-33-7W5 and LSD 6-32-32-6W5. Wells 12-21 and 11-35 are being used in the Demonstration Project.

The reservoir fluid composition shown in the Table 1 is based on several bottom-hole samples obtained during the 1969 extended production test of the 12-21 well. This analysis was on a water-free basis. Subsequent laboratory and equation-of-state studies indicated that the gas has a saturated water capacity of approximately 8 per

cent. During the 1969 bottom-hole sampling program, the total elemental sulphur content of the reservoir fluid was determined to be approximately 72 to 87 grams per cubic metre at the sampling conditions of 36 MPa pressure and 116°C temperature. Laboratory sulphur solubility data for high H₂S content gases indicate that the Bearberry reservoir fluid is near its saturation point with respect to sulphur content.

Equation-of-state studies indicate that the in situ reservoir fluid is in the gas phase. There will also be a connate water phase. Reduction in the fluid pressure will result in condensation of both water and liquid sulphur. For a given pressure reduction, the volumes of each liquid condensed are similar. Studies of the freezing point of sulphur at reservoir conditions indicate it will be in liquid form.

Production will constitute a three-phase system, consisting of gas, liquid sulphur and water phases. Calculations show that Joule Thomson cooling associated with the planned pressure drawdown caused by well production will not cause solidification of the liquid sulphur in the reservoir.

From a reservoir perspective, the principal objective of the Demonstration Project is to evaluate the effect of the sulphur and water deposition on the producibility of the reservoir. The results will then be used to predict the long term reservoir performance and ultimate sulphur recovery.

The effect of deposition on reservoir performance will be evaluated by purposely creating a severe depositional environment in the 11-35 well. This will be done by using a short completion interval, thereby creating high pressure drawdowns and high pore volume throughputs in the near wellbore region of the reservoir. By "accelerating" the precipitative behaviour, the long term reservoir performance will be determined from a relatively short term test. The 12-21 well has a larger completion interval and therefore a less severe reservoir depositional environment. Its performance is representative of a commercial operation.

The produced reservoir fluid composition is being

TABLE 1
RESERVOIR FLUID COMPOSITION

Component*	Water-free Basis (mole %)	In-Situ** (wet) (mole %)
Hydrogen Sulphide (H ₂ S)	90	84
Carbon Dioxide (CO ₂)	5	4
Methane (CH ₄)	4	4
Nitrogen (N ₂)	<1	<1
Ethane-Propane (C ₂ -C ₃)	trace	trace
Water (H ₂ O)	-	8

* Figures exclude the estimated 72 to 87 g/m³ of solubilized elemental sulphur (represents <1 mole %). Figures do not add to 100% due to rounding.

** In the reservoir.

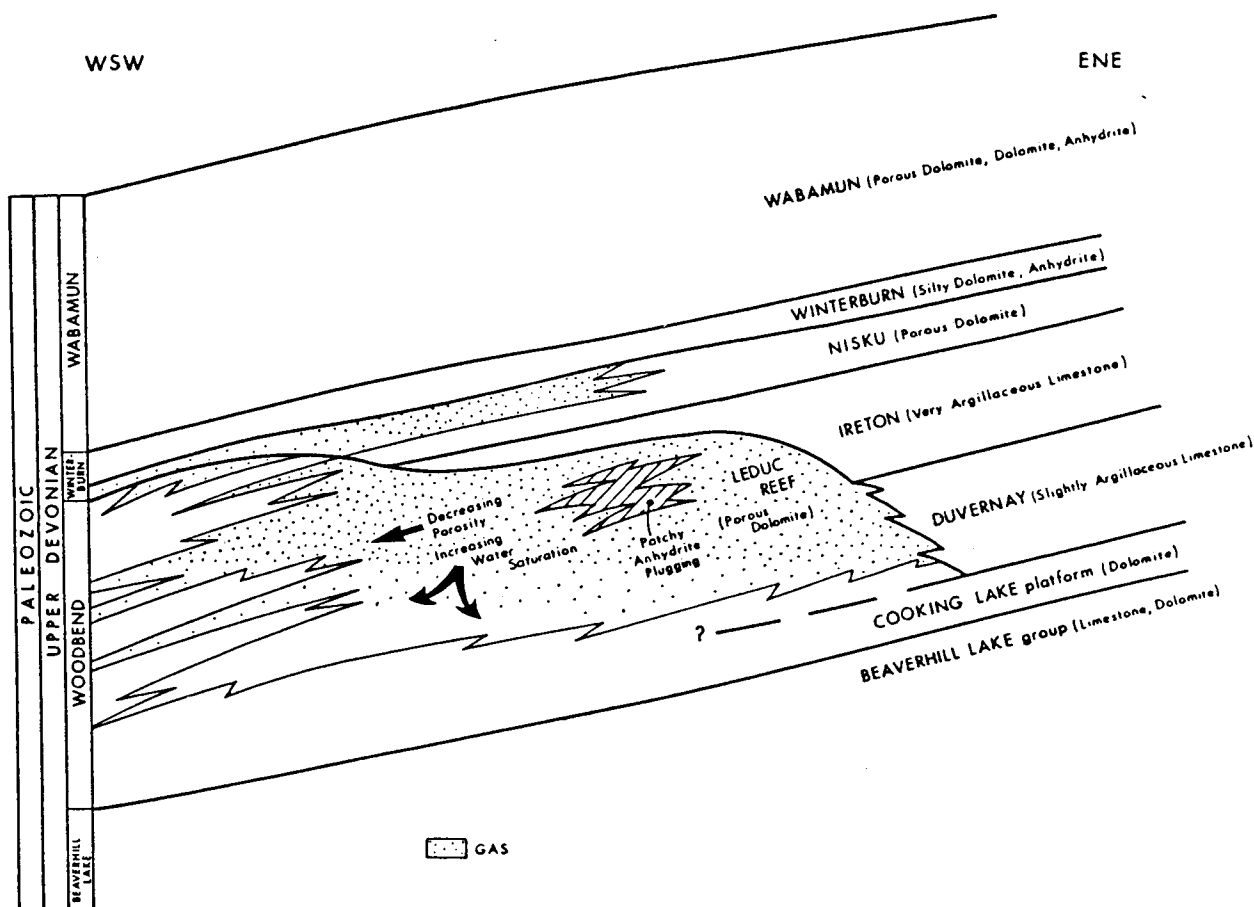

Figure 3. Schematic cross section: Upper Devonian.

confirmed during the operation by recombination of all components in the produced stream. This entails regular measurement, fluid sampling and subsequent lab analysis of well production. Downhole sampling is not planned.

Reservoir performance is being evaluated primarily through pressure transient analysis (build-ups, draw-downs and multi-rate tests) and also by comparing and analyzing historical rate versus flowing pressure data. Continuous downhole pressure and temperature measurements are provided.

Analysis of the pressure data is being conducted to detect changes in flow capacity which could be attributed to buildup of condensed fluids. Computer simulation is being used to assess the performance implications of any such buildup. Frequent testing is being undertaken during initial stages of the Project to ensure adequate baseline data is obtained.

The 11-35 well with a short perforated interval is expected to produce up to approximately 176 E³m³/d with a target drawdown of approximately 7-14 MPa. Any significant depositional buildup in the reservoir around this well should be detectable.

The 12-21 well with its longer completion interval will probably not show any detectable depositional buildup. This well is also expected to produce up to 176 E³m³/d raw plant feed rate with a minimal drawdown

(350 kPa or less). The 12-21 well will be used primarily to load level the sulphur plant.

WELLS

The wells are recompleted with concentric tubing strings to provide for oil circulation (Figure 4). The power oil tubing is landed in a production packer. The production tubing is landed inside the power oil tubing. A wireline retrievable jet pump is installed near the base of the production tubing. A standing valve is installed below the jet pump to prevent oil loss to the formation. The subsurface safety valve (SSSV) system includes a conventional safety valve positioned in the production tubing near surface, and a one-way check valve located in the jet pump to prevent reservoir fluid entry into the tubing annulus. Reservoir performance is monitored by downhole pressure and temperature sensors, which provide surface readouts via an electric cable strapped to the outside of the power oil tubing.

All wellhead and downhole materials meet NACE sour service standards and Bearberry materials specifications.

Corrosion of well equipment in contact with produced fluids are controlled by material selection, chemical inhibition and corrosion monitoring programs.

Wellheads and well equipment are made from ma-

materials that are inherently resistant to cracking under the most severe mechanical loading conditions in the worst case environment. No reliance is placed on inhibitors for cracking resistance. All possible upset, start-up and shut-down conditions are considered.

The sulphur carrier oil contains a pre-tested corrosion inhibitor which provides corrosion protection to all parts of the production systems with which it is in contact. Any equipment which is not contacted by an inhibitor is made of pre-tested corrosion resistant materials.

A corrosion monitoring program is an integral part of Bearberry well operations. Wellheads and other selected components are monitored by ultrasonic and radiographic techniques in addition to visual examination.

Sulphur carrier oil circulation is being used to prevent solid sulphur from depositing and plugging flow in the tubing. The oil mixes with the produced fluids near the bottom of the production tubing. Oil circulation maintains the elemental sulphur in solution to the plant, where it is removed in the processing facilities.

Jet pump artificial lift is being used to provide lift energy for the wells to achieve the desired bottomhole pressure drawdown and production rates. Artificial lift is needed to overcome the high vertical flowing pressure gradients in the mixture of reservoir fluid and circulation oil.

FIELD FACILITIES

Equipment at the two wellsites include the wellhead, a heater, a manual blowdown flarestack system and linalogging/pigging facilities.

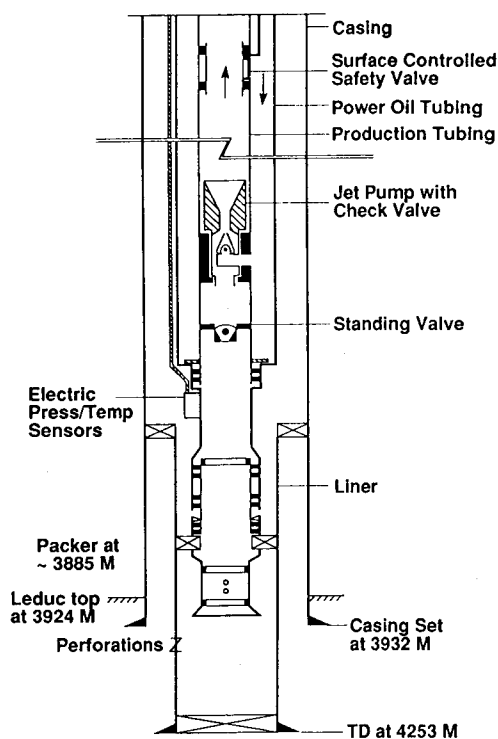

MOBIL GPD BANNER JAMES 11-35-33-7 W5M
PRODUCTION COMPLETION

Figure 4. Well completion.

Both wells are serviced by three pipelines: a production line, an oil circulation line and a fuel gas line. The production pipelines meet all sour service requirements and Bearberry materials specifications. Materials are selected to be inherently resistant to cracking under the most severe mechanical loading conditions in the worst case environment. No reliance is placed on corrosion inhibitors for cracking resistance.

Internal corrosion control of the production lines will be achieved by use of the inhibited circulating oil, which will also keep the elemental sulphur in solution. Linalogging for detection of corrosion will be done on a regular basis with the frequency determined by operating experience. Bellholes are provided at strategic locations to measure pipe conditions by ultrasonics and radiography.

PROCESS FACILITIES

The overall process flow scheme for the Bearberry project is shown in Figure 5. Lean carrier oil is routed through wellsite heaters and down the wells to provide lift and to ensure the sulphur remains in solution. The returning oil mixes with the well fluids, goes through a wellsite heater and, the mix, is pipelined to individual inlet separators at the plant.

From the inlet separators, the produced gas flashes overhead to a four stage sulphur plant with sub-dew point conversion. Up to 204 tonnes per day of liquid sulphur are produced and degassed to bring dissolved H_2S down to low levels, and routed to storage and shipment by truck. Emissions of up to 4.2 tonnes per day of sulphur are dispersed as sulphur dioxide through an incinerator and stack designed to meet Clean Air Act regulations and operating standards.

Liquids from the inlet separator - mainly sulphur carrier oil and the produced water - are routed to an H_2S stripper. Steam is used to strip gases from the mixture, and the gases are routed to the sulphur recovery unit. The condensed stripped water and oil are routed from the stripper to a tank for separation. The water is trucked offsite for downhole disposal, and the oil is routed to a regeneration circuit.

In the regeneration system, rich sulphur carrier oil is contacted with a solvent solution in a liquid-liquid extraction system which removes the entrained sulphur. The regenerated sulphur carrier oil is recycled to the wells. The rich solvent is stripped of sulphur and recycled in the process. The removed off-specification sulphur is pumped to the sulphur unit reaction furnace for conversion to sulphur product.

The Bearberry plant facilities are designed to minimize fugitive H_2S emissions. All safety valves and other equipment that could release H_2S are vented to the flare system. Tanks and vessels that contain sour fluids are closed and connected to a vapor recovery system that discharges either to flare or to the plant incinerator where all sulphur containing compounds are converted to sulphur dioxide.

ENVIRONMENTAL CONSIDERATIONS

Like with any project, the philosophy on the environment is to meet or better the requirements of all relevant legislation. The plant has a sub-dew point Claus Sulphur

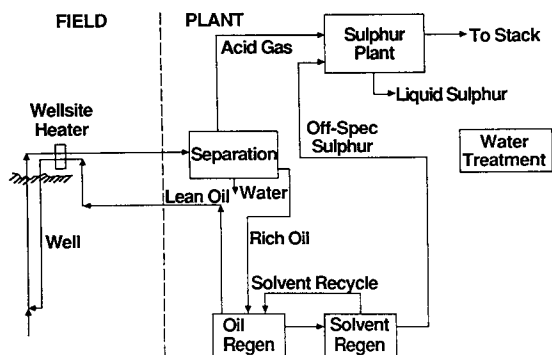

Figure 5. Process flow schematic.

Recovery Unit operating at a minimum of 98 per cent efficiency. The tail gas is burned to sulphur dioxide in a 57 metre incinerator stack. The plant flare stack is equipped with a smokeless flare tip to enhance combustion and eliminate smoke. Sulphur is not poured to block. Liquid sulphur is degassed prior to shipment by truck. A vapor recovery system is in place to minimize fugitive emissions. An air quality monitoring trailer and thirteen sulfation stations are located in the area and have gathered baseline data. During the operation, various monitoring programs are in effect to assess the environmental performance. The project is being operated safely and with minimal impact on the environment.

RESEARCH SUPPORT

The challenges of the project required significant research support. The role of research has been to provide information to assist the technical specialists with the design of the entire Demonstration Project. The design included the well testing approach, process flow, well equipment and surface facilities.

Research on the project was conducted since 1986 in labs worldwide. The majority of the effort was at Shell's Calgary Research Centre. Six other labs were involved: Shell's Oakville Research Centre in Ontario, Shell Oil's Westhollow Research Centre in Houston, Alberta Sulphur Research in Calgary, BASF in Germany, Batelle Laboratory in Ohio, and D.B. Robinson and Associates in Edmonton.

The cumulative effort is equivalent to some 39 man-years and \$5.5 million.

The subjects researched were: reservoir fluid properties, reservoir flow properties, production chemistry, corrosion inhibition, metallic and non-metallic materials performance and qualification, carrier oil properties, carrier oil and solvent regeneration, and emulsion behaviour.

The main technical issues that have been resolved are:

- Phase behaviour
 - In situ fluid composition
 - Sulphur/water dropout volumes
 - State of sulphur phase
- Physical properties
 - Viscosity and density of flowing phases

Joule-Thomson effects

- Fluid flow in reservoir
- Critical liquid saturations
- Relative Permeabilities
- Fluid-Rock interactions
- Non-Darcy flow

- Carrier oil and solvent selection
- Corrosion inhibitor and demulsifier selection
- Oil and solvent regeneration process selection
- Material selection for the entire system - downhole equipment, tubing, wellhead, wellsite piping, wellsite heater, pipeline, and plant.

Some research support is continuing to assist with interpretation of the operating performance of the Demo and to help with the assessment of the feasibility of a commercial project.

TIMING OF COMMERCIAL DEVELOPMENT

Technical success and acceptable market conditions could lead to commercial-scale development of the Bearberry field in the second half of the 1990s.

A commercial project could produce approximately 3500 tonnes per day and will likely be integrated with the nearby Caroline sour gas facility (Reference application to the Alberta Energy Resources Conservation Board, Caroline Project, Caroline - Bearberry Integration).

The timing/scheduling of a commercial project will be established once successful Demo results become available and the sulphur market is further assessed. The earliest potential timing for a commercial project to be onstream is in the mid to late 1990s.

ACKNOWLEDGMENTS

The authors wish to thank the management of Shell Canada, Mobil Oil Canada, PanCanadian Petroleum, and Norcen Energy Resources for permission to prepare and present this paper. We also wish to thank all the researchers and technical specialists for their first class efforts in the design and development of the World's first ultra sour gas project. Also, we would like to thank the Service Companies, Contractors and Suppliers for their excellent efforts in recompleting the wells and constructing the facilities. Lastly, we wish to thank the Operations staff for an outstanding job of producing the wells and operating these unique surface facilities.

REFERENCES

- Shell Canada Limited (1986): Bearberry Demonstration Project; Application to *The Alberta Energy Resources Conservation Board*.
- Shell Canada Limited (1990): Caroline Project, Caroline - Bearberry Integration; Application to *The Alberta Energy Resources Conservation Board*, Supplemental Information Volume II.

YTTRIUM ENRICHED PHOSPHORITES IN THE FERNIE BASIN, SOUTHEASTERN BRITISH COLUMBIA

By Jennifer Pell

Consultant to Formosa Resources Corporation,
Vancouver, B.C.

ABSTRACT

A series of predominantly marine strata, which range in age from Devonian to Jurassic, and nonmarine fluvio-deltaic sediments of the Late Jurassic and Cretaceous are exposed in a broad, doubly plunging synclinorium, commonly referred to as the Fernie basin. Phosphatic horizons are known to occur at a number of intervals within the section; however, phosphatic strata at the base of the Jurassic Fernie Group are considered to have the best economic potential and have been the focus of most exploration activity.

The basal Fernie phosphate horizon is generally 1 to 3.5 metres thick and consists of interbedded phosphorites, shaley phosphorites and phosphatic shales with average grades of 21 to 22 per cent P_2O_5 and local concentrations in excess of 30 per cent P_2O_5 . Preliminary beneficiation tests suggest that simple grinding and washing may be all that is required to upgrade the raw material to industry standard specifications for fertilizer plant feed, with acceptable P_2O_5 contents (27-42%), P_2O_5/CaO ratios and concentrations of deleterious elements such as MgO , Fe_2O_3 and Al_2O_3 . The Fernie phosphorites also contain anomalous concentrations of yttrium, averaging around 650 to 700 ppm versus the world phosphorite average of 275 ppm; byproduct recovery of yttrium could elevate these deposits to economic status.

Current exploration work has focussed on evaluating the grade and continuity of the basal Fernie phosphorite horizon in the southern and southeastern part of the Fernie Basin and locating areas with favorable conditions for mining (dip slope settings, etc.). Additional beneficiation and yttrium recovery studies are required.

INTRODUCTION

Canada imported 2.39 million tonnes of phosphate rock in 1986, approximately 80 per cent of which was used in the fertilizer industry. Other products which require the use of phosphorus include organic and inorganic chemicals, soaps and detergents, pesticides, insecticides, alloys, animal-food supplements, ceramics, beverages, catalysts, motor lubricants, photographic materials and dental and silicate cements. To date, there are no mines producing phosphate rock in Canada; however, approximately 55 million tonnes per annum are produced in the United States. Approximately 50 per cent of the phosphate rock imported into western Canada comes from Florida, the remainder being supplied from the western U.S.. The majority of phosphate rock imported into eastern Canada is also from Florida; minor amounts have also been imported from Togo, Tunisia and Morocco (Barry, 1987; Stowasser, 1988). Resources in Florida are rapidly being depleted; some experts feel that the western U.S. sources will not be able to meet the demand when Florida becomes exhausted, which suggests a pos-

sible niche for a new producer. Yttrium (atomic number 39) is an element that is closely associated with the rare earths (lanthanides) in occurrence, chemical properties and end use applications. The principal uses for yttrium are in producing red phosphors for colour television picture tubes, and other cathode ray tubes and in the production of commercial garnets for microwave controls and the fabrication of lasers used in cutting, drilling and welding. It is also used in the production of some advanced ceramics, in magnesium alloys, in stainless steel to impart high-temperature corrosion resistance characteristics and in cobalt and nickel based superalloys used in jet engines and turbine blades (Hendrick, 1985). Yttrium is commercially recovered from heavy mineral placers (monazite and xenotime placers) predominantly from Australia, Thailand, Malaysia, India, Brazil and China. Since 1986, yttrium concentrates have also been extracted as a byproduct of uranium processing at Elliot Lake, Ontario. Currently, there is no reported byproduct recovery of yttrium from any phosphate operations.

Phosphatic strata in the western Canadian Cordillera were discovered in 1925 and have been the subject of periodic exploration activity since that time, much of which has been focussed on beds at the base of the Jurassic Fernie Group (Christie, 1979; Kenny, 1977; Telfer, 1933). Recent government studies have indicated that Fernie phosphorites located near the southern and eastern limits of their exposure have the best economic potential (Butrenchuk, 1987 & in press; Macdonald, 1985; 1987). The phosphorite beds in the Fernie Group are thin relative to most phosphorites mined in the United States and, as with most of the U.S. phosphate ores, would require beneficiation to produce a product suitable for use in fertilizer plants. They contain anomalous concentrations of yttrium with respect to most other sedimentary phosphate deposits; averaging 650 to 700 ppm yttrium versus the world phosphorite average of 275 ppm yttrium (Altschuler, 1980; Butrenchuk, 1987). If it proves feasible to recover yttrium during the production of phosphoric acid, as has been suggested by some researchers (Altschuler, *et al.*, 1967), the economics of exploiting the Fernie Group basal phosphorite horizon will become significantly more attractive.

The most recent exploration in the area was conducted by Formosa Resources Corporation of Vancouver; seven properties southeast of the town of Fernie, B.C., near the southern and eastern limits of the area underlain by Fernie Group strata, were examined (Figure 1). The primary objective of this work was to evaluate the grade and continuity of the basal Fernie phosphate horizon in terms of establishing its potential as a large tonnage P_2O_5 -Y resource and to identify areas with optimum mining conditions.

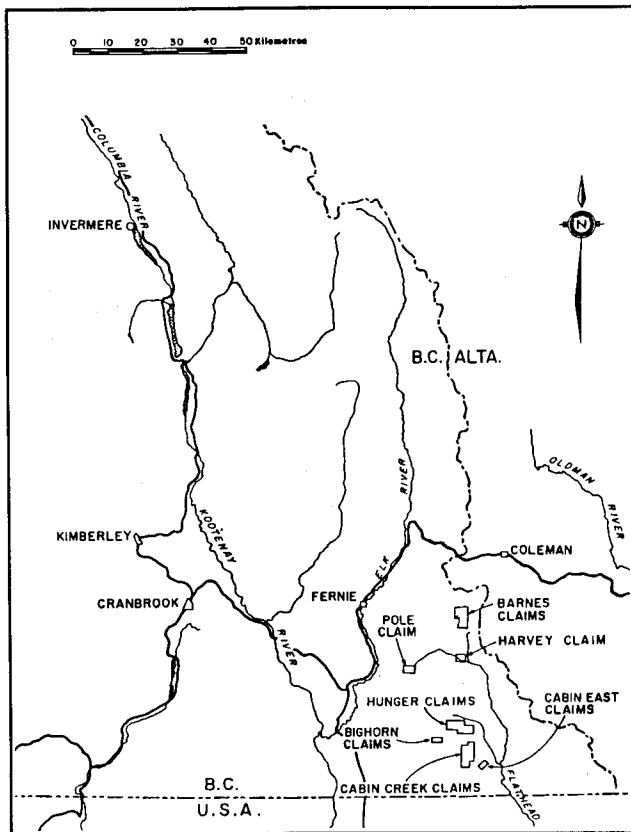

Figure 1. Location map.

REGIONAL GEOLOGY

In southeastern British Columbia, a series of predominantly marine strata which range in age from Devonian to Jurassic and nonmarine fluvio-deltaic sediments of late Jurassic to Cretaceous age are exposed in a broad, doubly plunging synclinorium, commonly referred to as the Fernie Basin (Newmarch, 1953; Price, 1965; 1964; 1962; 1961). This synclinorium is broadly delineated by the distribution of the Jurassic Fernie Group (Figure 2); however, the structure is complicated by second order folds, easterly directed thrust faults and west-side-down normal faults. Phosphatic horizons (Figure 3) are known to occur at a number of intervals within the Paleozoic and Mesozoic stratigraphy; those at the base of the Fernie Group are considered to have the best economic potential (Butrenchuk, 1987; Kenny, 1977; Macdonald, 1987; Telfer, 1933).

REGIONAL STRATIGRAPHY

Upper Devonian strata exposed in the vicinity of the Fernie Basin consist of massive, grey, fine-grained, cliff forming limestones of the Palliser Formation. They are overlain by the Devonian-Mississippian Exshaw Formation, which is generally 6 to 30 metres in thickness and predominantly consists of black, fissile shale, cherty shale, siltstone and minor limestone. Four phosphatic horizons exist within the Exshaw Formation: the lowest is less than 50 centimetres thick and has grades of less than 9 per cent P_2O_5 ; the middle two horizons are both around one metre thick, have grades of up to 10 per cent P_2O_5 and are separated by approximately two metres of shale; and the uppermost phosphatic zone, which has

very limited extent, contains grades which always exceed 15 per cent P_2O_5 and is always less than 15 centimetres thick (Kenny, 1977; Macdonald, 1987).

The Mississippian Banff Formation has a gradational contact with the underlying Exshaw Formation. It is 280 to 430 metres thick and consists of dark grey, fissile shale and bands of argillaceous limestone that grade upward into dark grey, massive, finely crystalline limestone and dolostone. The Mississippian Rundle Group conformably overlies the Banff Formation and attains a thickness of approximately 700 metres. It consists of a series of resistant, thick-bedded crinoidal limestones, grey and black, finely crystalline limestones, dark, argillaceous limestones, dolostones and minor black and green shale (Butrenchuk, 1987; Kenny, 1977).

Conformably overlying the Mississippian carbonates are Pennsylvanian strata of the Spray Lakes Group which consist of a lower unit, the Tunnel Mountain Formation and an upper unit, the Kananaskis Formation. The Tunnel Mountain Formation comprises a uniform, monotonous sequence of reddish-brown weathering dolomitic sandstone and siltstone that attains a maximum thickness of 500 metres at its western margin, near the Elk River. The Tunnel Mountain Formation is disconformably overlain by the Kananaskis Formation which consists of light grey, silty dolostones and dolomitic siltstones and is generally around 55 metres thick. Chert nodules and intraformational chert breccias are located in the upper

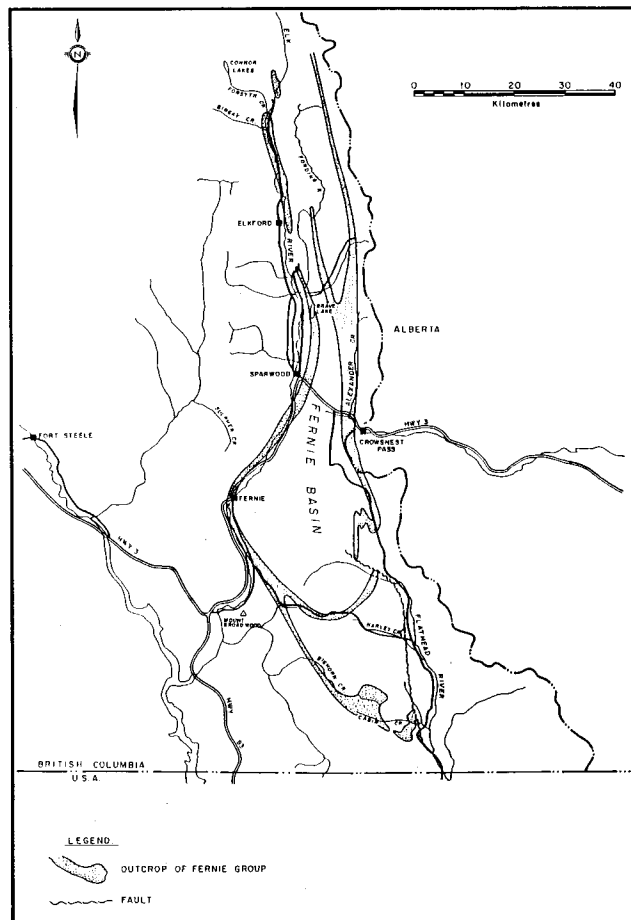

Figure 2. Distribution of Fernie Group strata.

Age	Group/Formation (Thickness,metres)	Lithology	Phosphatic Horizons	Thickness (metres)	Grade (% P ₂ O ₅)	
Cretaceous	Kootenay Fm.	-grey to black carbonaceous siltstone and sandstone; nonmarine; coal				
Jurassic	Fernie Gp. (±244)	-black shale, siltstone, limestone; marine to nonmarine at top -glauconitic shale in upper section -belemnites; common fossil	-approximately 60 metres above base low-grade phosphate bearing calcareous sandstone horizon or phosphatic shale -Bajocian -basal phosphate in Sinemurian strata; generally pelletal/oolitic; rarely nodular; 1-2 metres thick; locally two phosphate horizons; top of phosphate may be marked by a yellowish-orange weathering marker bed.	1-2	11-30	
----- regional unconformity -----						
Triassic	S P R A Y R I V E R G P.	Whitehorse Fm.	-dolomite, limestone, siltstone			
		Sulphur Mtn. Fm. (100-496)	-grey to rusty brown weathering sequence of siltstone, calcareous siltstone and sandstone, shale, silty dolomite and limestone			
----- regional unconformity -----						
Permian	R O C K I L L I E S T R O P H I C P.	Ranger Canyon Fm. (1-60)	-sequence of chert, sandstone and siltstone; minor dolomite and gypsum; conglomerate at base -shallow marine deposition	-upper portion brown, nodular phosphatic sandstone; also rare pelletal phosphatic sandstone (few centimetres to +4 metres) -basal conglomerate-chert with phosphate pebbles present (<1 metre)	0.6 0.5-1.0	9.5 13-18
		unconformity				
		Ross Creek Fm. (90-150)	-sequence of siltstone, shale, chert, carbonate and phosphatic horizons areally restricted to Telford thrust sheet -west of Elk River, shallow marine deposition	-phosphate in a number of horizons as nodules and finely disseminated granules within the matrix -phosphatic coquinoïd horizons present	0.4-1.0	1.7-6.0
		Telford Fm. (210-225)	-sequence of sandy carbonate containing abundant brachiopod fauna; minor sandstone -shallow marine deposition	-rare, very thin beds or laminae of phosphate; rare phosphatized coquinoïd horizon	0.3	11.4
Permian	P E R M I A N P.	Johnson Canyon Fm. (1-60)	-thinly bedded, rhythmic sequence of siltstone, chert, shale, sandstone and minor carbonate; basal conglomerate -shallow marine deposition	-locally present as a black phosphatic siltstone or pelletal phosphate -phosphate generally present as black ovoid nodules in light coloured siltstone; phosphatic interval ranges in thickness from 1-22 metres -basal conglomerate (maximum 30 cm thick) contains chert and phosphate pebbles	0.2-0.3 1-22 1-2	3.0-4.0 0.1-11.0 14.2-21.2
	----- regional unconformity -----					
	Pennsylvanian	S P R A Y L A K E S T R O P H I C P.	Kananeskia Fm. (±55)	-dolomite, silty, commonly contains chert nodules or beds	-locally, minor phosphatic siltstone in uppermost part of section	
		Tunnel Mtn Fm. (±500)	-dolomitic sandstone and siltstone			
Mississippian		Rundle Gp. (±700)	-limestone, dolomite, minor shale, sandstone and cherty limestone			
		Banff Fm. (280-430)	-shale, dolomite, limestone			
Devonian-Mississippian		Exshaw Fm. (6-30)	-black shale, limestone -areally restricted in south-eastern British Columbia	-an upper nodular horizon -phosphatic shale and pelletal phosphate 2-3 metres above base -basal phosphate <1 metre thick		
Devonian		Palliser Fm.	-limestone			

Figure 3. Stratigraphic summary including phosphate-bearing horizons in southeastern British Columbia (modified from Butrenchuk, 1987). Thickness not to scale.

part of the section. Slightly phosphatic horizons, containing up to 9 per cent P_2O_5 , are reported as rare occurrences within the Kananaskis Formation (Macdonald, 1987).

The Spray Lakes Group is unconformably overlain by Permian strata of the Ishbel Group and together, they comprise the Rocky Mountain Supergroup (Figure 3). The Ishbel Group, which has been correlated with the Phosphoria Formation in the western United States, consists of the Johnston Canyon, Telford, Ross Creek and Ranger Canyon formations, from oldest to youngest, respectively.

The Johnston Canyon Formation comprises a series of recessive weathering, thin to medium-bedded siltstones, silty carbonate rocks and sandstones, with minor shale and chert. It varies from 1 to 60 metres in thickness and commonly contains phosphatic rocks. Thin, intraformational, phosphate-pebble conglomerate beds are common throughout the formation and, locally, mark its base. Phosphate is present as black nodules in distinct horizons within the siltstones, locally cements siltstone beds and, locally occurs in pelletal siltstone or pelletal silty phosphorite beds which are slightly greater than 1 metre in thickness (Butrenchuk, 1987; Macdonald, 1987). The pelletal phosphorites can contain up to 21 per cent P_2O_5 , but are of limited distribution; the basal conglomerate is less than 50 centimetres thick and generally contains 3 to 4 per cent P_2O_5 , only; the nodular and phosphate pebble-conglomerate beds can have cumulate thicknesses of up to 22 metres, but grades rarely exceed 10 per cent P_2O_5 over a few tens of centimetres.

The Telford and Ross Creek Formations are of limited distribution, exposed only in the Sparwood region. Slightly phosphatic rocks are reportedly present in both these formations (Butrenchuk, 1987; Macdonald, 1987).

The Ranger Canyon Formation, which can be up to 60 metres thick, paraconformably to disconformably overlies the Ross Creek Formation. It predominantly consists of resistant, cliff-forming, thick-bedded, blue-grey cherts, cherty sandstones, siltstones, fine sandstones and conglomerates. Minor gypsum and dolomite are also present. The base of the formation is marked by thin, phosphate-cemented, chert-pebble conglomerates that locally contain massive, phosphatic intraclasts. Phosphate also occurs as nodules in brownish weathering sandstone beds in the upper part of the formation. With the exception of phosphatic strata near the Fernie ski hill, most of the horizons are reportedly low grade; the highest values reported are 13.3 per cent P_2O_5 across 0.5 metres (Butrenchuk, 1987; Macdonald, 1987).

Permian strata are unconformably overlain by the Triassic Sulphur Mountain Formation of the Spray River Group. The Sulphur Mountain Formation is between 100 and 496 metres thick and typically consists of rusty brown weathering, medium-bedded siltstones, calcareous and dolomitic siltstones, silty dolostones and limestones and minor shale. Locally, the Sulphur Mountain Formation is overlain by pale weathering, variegated dolostones, limestones, sandstones and intraformational breccias of the Whitehorse Formation, which the upper member of the Spray River Group, but is not present in most parts of the Fernie Basin (Butrenchuk, 1987).

The Jurassic Fernie Group unconformably overlies

the Triassic strata. It consists of a lower zone of dark grey to black shales, dark brown shales, phosphates and minor limestones, siltstones and sandstones (the basal phosphate zone and equivalent Nordegg Member, Poker Chip Shales and the Rock Creek Member), a middle unit of light grey shale, calcareous sandstone and sandy limestone (the Grey Beds) and an upper unit of yellowish-grey to pale brown or dark grey weathering glauconitic sandstone and shale grading upwards into interbedded fine-grained sandstone, siltstone and black shales (the Green and Passage beds). In southeastern British Columbia, the Fernie Group is 70 to 376 metres in thickness and generally thickens to the west (Freebold, 1957; Kenny, 1977; Macdonald, 1987; Price, 1965).

The base of the Fernie Group is marked by a persistent pelletal phosphorite horizon that either rests directly on Triassic strata or is separated from the underlying rocks by a thin phosphatic conglomerate. Phosphatic shales of variable thickness overlie the phosphorite. The top of this sequence is locally marked by a yellow-orange bentonite bed. This part of the formation is generally considered to be a lateral facies of the Sinemurian Nordegg Member and Nordegg equivalent beds. A second phosphatic horizon is present in the Bajocian Rock Creek Member, approximately 60 metres above the base of the Fernie Group. This zone is extremely low grade, generally containing less than 1 per cent P_2O_5 and is often associated with belemnite-bearing calcareous sandstone beds (Butrenchuk, 1987; Freebold, 1957; Macdonald, 1987).

The Kootenay Formation, of upper Jurassic to Cretaceous age, overlies rocks of the Fernie Group. It consists of dark grey carbonaceous sandstone, gritty to conglomeratic sandstone, siltstone, shale and coal and can be from 150 to 520 metres thick (Price, 1965).

THE BASAL FERNIE GROUP PHOSPHORITE HORIZON IN THE SOUTHERN AND EASTERN PARTS OF THE FERNIE BASIN

The main phosphatic horizon in the Fernie Group occurs at its base and was deposited during Lower Jurassic (Sinemurian) time at high paleolatitudes, approximately 40° north. This is a somewhat unusual spatial and temporal setting for phosphorite occurrences; the Lower Jurassic is not a time period commonly associated with phosphate deposition and most deposits on a world-wide basis were formed at paleolatitudes of 10 to 20° north or south of the equator (Cook and McElhinny, 1979; Christie, 1980).

The basal phosphorite horizon is 1 to 2 metres in thickness, and generally contains greater than 20 per cent P_2O_5 . Its distribution, on the property scale, is defined by upright to overturned folds and northwesterly directed thrust faults that are characteristic of the Foreland Belt. Locally, thrust faults complicate the stratigraphy of the phosphorite itself, through repetition and omission of units; in the Harvey Creek/Flathead River area the phosphate horizon, or parts of it, have been fault repeated as many as five times.

STRATIGRAPHY OF THE BASAL FERNIE GROUP PHOSPHORITES

In the southern part of the Fernie Basin, near Cabin

Creek, a tripartite division of the basal phosphorite horizon was commonly observed (Figure 4). It consists of a lower pelletal phosphorite to phosphatic shale horizon, 25 to 153 centimetres thick that either sits directly on hard Triassic siltstones or on a weathered, clay-rich Triassic base mixed with some phosphate. This horizon is overlain by an intermediate zone, 5 to 63 centimetres thick, consisting of chocolate to black shale which in turn overlain by an upper pelletal, or in some cases, nodular phosphorite which is generally between 18 and 137 centimetres thick. The upper phosphorite horizon is overlain by slightly phosphatic black or brown shales that grade upwards into nonphosphatic rocks and in some cases are capped by one, or more, thin yellow-orange weathering bentonite beds. The thickest section encountered was 3.5 metres, with an average grade of 20.5 per cent P₂O₅ and 700 ppm yttrium (Table 1). In some exposures, the section is incomplete; often the top of the section has either been removed by erosion or mixed with shale and glacial till.

Along the eastern margin of the basin, in the Barnes Lake area, the phosphorite horizon overlies interbedded buff to brown Triassic shales and siltstones or orange to yellow clays (weathered siltstones). The lowest phosphatic units commonly contain angular orange weathering fragments, probably derived from the underlying Triassic beds, that diminish in abundance upsection. The phosphorites are generally shaley to pelletal in nature and exhibit an increase in grade upsection until a fairly pure phosphorite, containing between 27 and 32 per cent P₂O₅ is developed. Commonly, this high-grade phosphorite is black, pelletal (gritty textured) and is overlain by increasingly shaley phosphorite, shale and, locally, thin beds of very hard, massive siltstone. Phosphate nodules hosted in a pelletal phosphate matrix are locally developed in the high-grade beds. Incomplete sections exhibit similar trends, but are often complicated through mixing and erosion of units. The phosphatic section in this area is generally 1.11 to 2.07 metres in thickness, with the highest grade section ranging from 30 centimetres to 1 metres in thickness and averaging 60 centimetres (Table 1).

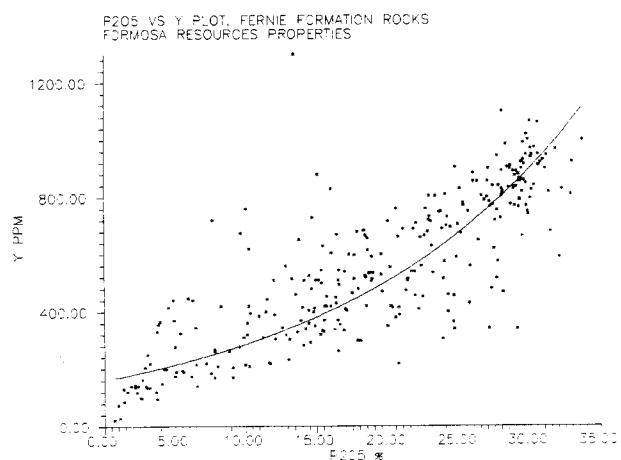

Figure 4. P₂O₅ vs Y plot, Fernie Group rocks (Formosa Resources Properties).

TABLE 1
REPRESENTATIVE MEASURED SECTIONS,
SOUTHEASTERN FERNIE BASIN

SECTION	THICKNESS METRES*	WEIGHTED AVERAGES* P ₂ O ₅ %	PROPERTY Y PPM
CBC89-18	1.50	22.61	667
CBC89-22	1.00	18.52	615
CBC89-35	3.51	20.47	709
(CONTAINS	1.37	27.75	997)
TR89-10-1	1.28	20.16	573
TR89-11-1	1.21	17.08	537
TR89-12-1	1.15	18.93	546
HGR89-19	1.13	25.16	722
HGR89-21(1)	1.06	19.44	545
HGR89-21(2)	1.10	23.76	605
TR89-1-1	1.44	21.95	665
TR89-1-2	1.22	23.02	679
TR89-1-3	1.06	21.17	589
TR89-1-5	0.90	21.26	655
TR89-3-1	1.42	21.88	628
TR89-3-2	1.39	22.44	621
TR89-3-3	2.18	21.21	649
TR89-5-1	1.66	24.52	669
TR89-5-2	0.82	23.66	661
TR89-5-3	1.28	21.70	521
TR89-5-4	1.24	27.21	887
TR89-5-5	1.10	21.89	629
TR89-6-1	1.00	21.16	581
TR89-6-2	0.96	19.17	474
BN90-23**	0.98	30.50	777
BNT90-3-1	1.11	23.16	629
BNT90-3-2	1.11	21.63	712
BNT90-5-1	1.24	23.73	643
BNT90-7	1.45	23.58	595
BNT90-8	1.62	20.94	493
BNT90-9	2.07	22.14	565
HVT90-1-EF**	1.41	23.32	743
HVT90-1-GH**	0.91	20.60	630
HVT90-2-AB**	1.31	25.21	766
HVT90-3-1 **	2.45	21.88	664
HVT90-3-2 **	1.01	23.37	699
HVT90-3-3 **	2.08	22.91	664
HVT90-4-AB**	1.08	25.43	755

*Thicknesses quoted are all true stratigraphic thicknesses, either measured as such or calculated.

*Measured sections are generally composed of a number of smaller interval samples; weighted averages, based on proportional samples thicknesses, were calculated to represent the Y and P₂O₅ content of the entire section.

**Thickness affected due to erosion or faulting

GEOCHEMISTRY OF THE BASAL FERNIE GROUP PHOSPHORITES

Sections of the phosphorite horizon that were measured and sampled in detail contained on average 20 to 22 per cent P₂O₅ and 600 to 700 ppm Y across average thicknesses of 1 to 2 metres (Table 1); grades of up to 33 per cent P₂O₅ and 1300 ppm yttrium were encountered across smaller intervals. There is a direct relationship between yttrium and phosphate values within these rocks (Figure 4) that can be expressed by the exponential equation: $Y \text{ (ppm)} = \text{EXP}[0.057524 \text{ P}_{2}\text{O}_{5}(\%)] * 160.951624$. In the simplest of terms, as the phosphate content of the rock increases, so does the yttrium.

Phosphate rock from the Fernie is generally low in magnesium (less than 1%), but contains variable amounts of other deleterious compounds such as iron and aluminum, with up to 3.5 and 7.1 oxide weight per cent, respectively (Table 2). Calcium versus phosphate ratios are generally in the range of 1.37 to 1.49.

ECONOMIC CONSIDERATIONS

Phosphate rock is mined in the western United States (Idaho, Montana, Wyoming, Utah) from the Re-tort and Meade Peak members of the Permian Phosphoria Formation. The majority are strip mining operations with ore zones ranging from 9 to 18 metres thick, with an average grade of 21.3 per cent P₂O₅ and 300 ppm Y. Overburden thickness is commonly 5 to 10 metres

TABLE 2
GEOCHEMISTRY OF SELECTED FERNIE GROUP
PHOSPHORITES

SAMPLE	P ₂ O ₅	Y	SiO ₂	CaO	Al ₂ O ₃	Fe ₂ O ₃	LOI	MgO	CaO/ P ₂ O ₅	R ₂ O ₃ / P ₂ O ₅	PROPERTY
TR89-3-BP**	32.83	810	10.10	45.10	2.20	0.89	3.64	0.29	1.37	0.10	Hunger Lake
TR89-3-B1*	29.83	740	15.30	42.90	3.45	1.42	3.85	0.39	1.44	0.18	Hunger Lake
TR89-5-BP**	33.86	1000	9.58	45.80	2.24	0.91	3.49	0.25	1.36	0.10	Hunger Lake
TR89-5-B2*	29.39	960	16.80	40.00	3.63	1.44	3.67	0.39	1.36	0.18	Hunger Lake
HT90-3-3C	27.48	719	18.60	37.50	3.95	1.87	4.35	0.99	1.36	0.25	Harvey Creek
BNT90-9B	30.53	911	13.10	45.20	3.20	1.32	5.24	0.33	1.48	0.16	Barnes Lake
BNT90-1A	29.93	1065	15.20	41.10	3.75	1.61	5.96	0.42	1.37	0.19	Barnes Lake
BNT90-1B	29.96	796	14.30	41.00	3.71	1.99	6.37	0.42	1.37	0.20	Barnes Lake
BNT90-1C	24.56	385	25.40	35.80	4.79	1.18	5.81	0.42	1.46	0.26	Barnes Lake
BNT90-1D	18.34	667	38.00	25.50	7.12	2.46	5.20	0.66	1.39	0.56	Barnes Lake
BNT90-2A	30.50	1061	14.30	42.10	3.53	1.39	5.63	0.34	1.39	0.17	Barnes Lake
BNT90-2B	23.11	536	28.10	33.00	5.75	1.79	6.24	0.51	1.43	0.35	Barnes Lake
BNT90-3-1C	30.26	974	14.60	42.15	3.57	1.31	5.26	0.35	1.39	0.17	Barnes Lake
BNT90-3-1D	24.17	460	25.80	35.40	5.00	1.84	6.13	0.43	1.46	0.29	Barnes Lake
BNT90-3-1E	18.15	657	36.70	25.80	6.67	2.59	5.11	0.57	1.42	0.54	Barnes Lake
BNT90-3-2C	29.79	1001	15.40	41.70	3.82	1.43	5.33	0.37	1.40	0.19	Barnes Lake
BNT90-3-2D	22.71	680	28.20	32.20	5.54	1.60	6.32	0.44	1.42	0.33	Barnes Lake
BNT90-23A	31.39	681	14.00	43.70	3.52	1.07	4.70	0.29	1.39	0.16	Barnes Lake
BNT90-23B	32.91	924	10.20	45.90	2.80	0.96	4.96	0.23	1.39	0.12	Barnes Lake
LP790-1-1A	17.93	299	33.80	26.40	6.46	3.00	7.62	0.59	1.47	0.56	Lodgepole Creek
LP790-1-1C	27.88	727	21.10	40.00	4.04	1.34	4.19	0.45	1.43	0.21	Lodgepole Creek
LP790-1-2B	20.88	219	32.70	30.20	4.79	3.10	7.36	0.41	1.46	0.40	Lodgepole Creek
LP790-1-2D	21.73	690	29.30	32.00	7.12	2.12	6.01	0.72	1.47	0.46	Lodgepole Creek
LP790-1-3B	18.07	297	36.10	25.50	5.69	3.31	6.96	0.50	1.41	0.53	Lodgepole Creek
LP790-1-3D	17.85	299	33.90	25.60	6.25	3.53	7.75	0.70	1.43	0.59	Lodgepole Creek
LP790-2C	27.15	767	21.60	40.40	4.20	1.46	4.69	0.52	1.49	0.23	Lodgepole Creek

*Bulk sample, representative split; **Bulk sample split, washed (panned) to remove impurities

(Fantel *et al.*, 1984). Cominco American operates an underground phosphate mine in Montana, where the phosphate horizon is 1 to 1.2 metres thick and has an average grade of greater than 31 per cent P₂O₅. Most western U.S. phosphate ore is beneficiated by crushing, washing, classifying and drying (Stowasser, 1985). Phosphates mined in Florida and South Carolina are from the Miocene Hawthorne Formation and the younger, reworked deposits of the Bone Valley Formation. Ore thickness range from 3 to 8 metres, with overburden of 3 to 10 metres. Average grade is 7 per cent P₂O₅ and 235 to 300 ppm Y. Flotation processes are used to beneficiate the ores. Phosphates mined in Tennessee have a minimum cutoff grade of 16 to 17.2 per cent P₂O₅, a minimum thickness of 0.6 to 1.2 metres and average 63 ppm Y (Altschuler, 1980; Fantel *et al.*, 1984).

By western U.S. and Florida standards, the Fernie phosphorite beds are thin, but have reasonable P₂O₅ grades and are anomalously enriched in yttrium. As with most of the phosphate ores mined in the United States, Fernie phosphorites would require beneficiation to produce an acid grade product (fertilizer plant feed) with the following specifications:

- *P₂O₅ content: 27 to 42%
- CaO/P₂O₅ ratio: 1.32 to 1.6
- R₂O₃/P₂O₅: <0.1; (R₂O₃=Al₂O₃+Fe₂O₃+MgO)
- MgO content %

In particular, the phosphate content of the raw material would have to be upgraded by removing shaley impurities and deleterious compounds, i.e. reduce the R₂O₃/P₂O₅ ratio, which is generally in excess of 0.1 per cent (Table 2). A simple washing test (removing silts by crude panning) was conducted on high grade bulk samples from the Hunger Lake area (see TR89-3 & 5, Table 2). It resulted in an increase in both phosphate and yttrium values by 9 to 13.5 and 7 to 15.5 relative per cent, respectively and a decrease in deleterious components to

acceptable levels. More sophisticated metallurgical tests on more representative material would be necessary to establish if an acceptable product could be produced from the Fernie phosphorites.

DISCUSSION

Preliminary work has identified a number of areas within the southeastern parts of the Fernie Basin in which significant amounts of phosphate should be easily recoverable. In these areas, the following criteria are met:

1. The relationship between topography and the orientation of strata facilitates strip mining by minimizing stripping ratios.
2. Overburden is soft and should be removable by scraping (no blasting would be necessary).
3. The properties have been logged and good road access has been established.

Good logistical and political support exists in the area as it is an active coal mining region. Environmental concerns should be minimized as the region has been extensively logged and is no longer pristine wilderness.

The phosphorites in the Fernie Basin, although extensive and relatively easy to extract, are quite thin and, based on their P₂O₅ content, are probably currently subeconomic. As well, no work has yet been done to evaluate the effects of surface weathering on overall grade. These deposits might be upgraded to economic status if it were possible to recover yttrium during conventional phosphoric acid production as has been suggested by some researchers (Altschuler *et al.*, 1967); however, no reports indicate that this is being done at present and it is probable that the process would need to be developed. Current low yttrium prices suggest that this is not likely in the near future. A significant resource exists in these phosphorites and, in the future, it may prove economical to exploit it.

ACKNOWLEDGMENTS

Thanks are extended to Formosa Resources Corporation for allowing publication of this material and to Steve Butrenchuk and Dan Hora for sharing their material on these deposits and for many helpful discussions.

REFERENCES

- Altschuler, Z.S. (1980): The geochemistry of trace elements in marine phosphorites, part 1: Characteristic abundances and enrichment; *Society of Economic Paleontologists and Mineralogists*, Special Publication Number 29, pages 19-30.
- Altschuler, Z.S., Berman, S. and Cuttitta, F. (1967): Rare earths in phosphorites-Geochemistry and potential recovery; *United States Geological Survey*, Professional Paper 575B, pages B1-B9.
- Barry, G.S. (1987): Phosphate; in *Canadian Minerals Yearbook*, 1987 Edition, *Energy, Mines and Resources Canada*, pages 49.1 to 49.7.
- Butrenchuk, S.B. (in preparation): Phosphate deposits in British Columbia; *B.C. Ministry of Energy, Mines and Petroleum Resources*, Paper.
- Butrenchuk, S.B. (1987): Phosphates in southeastern British Columbia (82G and 82J); *B.C. Ministry of*

- Energy, Mines and Petroleum Resources*, Open File 1987-16, 103 pages.
- Christie, R.L. (1980): Paleolatitudes and potential for phosphorite deposition in Canada; in *Current Research*, Part B, *Geological Survey of Canada*, Paper 80-1B, pages 241-248.
- Christie, R. L. (1979): Phosphorites in sedimentary basins of western Canada; in *Current Research*, Part B, *Geological Survey of Canada*, Paper 79-1B, pages 253-258.
- Cook, P.J. and McElhinny, M.W. (1979): A re-evaluation of the spatial and temporal distribution of sedimentary phosphate deposits in the light of plate tectonics; *Economic Geology*, Volume 74, pages 315-330.
- Fantel, R.J., Anstett, T.F., Peterson, G.R., Porter, K.E. and Sullivan, D.E. (1984): Phosphate rock availability-World; *United States Department of the Interior*, Bureau of Mines Information Circular 8989, 65 pages.
- Freebold, H. (1957): The Jurassic Fernie Group in the Canadian Rocky Mountains and Foothills; *Geological Survey of Canada*, Memoir 287, 197 pages.
- Hendrick, J.B. (1985): Rare-earth elements and yttrium; in *Mineral Facts and Problems*, *United States Department of the Interior*, Bureau of Mines Bulletin 675, pages 1-18.
- Kenny, R.L. (1977): Exploration for phosphate in southeastern British Columbia by Cominco Ltd.; Paper presented at *Canadian Institute of Mining and Metallurgy*, Annual Meeting, Ottawa, Ontario.
- Macdonald, D.E. (1987): Geology and resource potential of phosphates in Alberta; *Alberta Research Council*, Earth Sciences Report 87-2, 65 pages.
- Macdonald, D.E. (1985): Geology and resource potential of phosphates in Alberta and portions of southeastern British Columbia; unpublished M.Sc. Thesis, *University of Alberta*, 238 pages.
- Newmarch, C.B. (1953): Geology of the Crowsnest Coal Basin with special reference to the Fernie area; *B.C. Ministry of Energy, Mines, and Petroleum Resources*, Bulletin No. 33, 107 pages.
- Price, R.A. (1965): Flathead map area, British Columbia and Alberta; *Geological Survey of Canada*, Memoir 336.
- Price, R. A. (1964): Flathead (Upper Flathead, east half), British Columbia-Alberta; *Geological Survey of Canada*, Map 1154A (1:50,000).
- Price, R. A. (1962): Fernie map area, east half, Alberta and British Columbia, 82G/E1/2; *Geological Survey of Canada*, Paper 61-24.
- Price, R. A. (1961): Fernie (East half); *Geological Survey of Canada*, Map 35-1961 (1:126,720).
- Stowasser, W.E. (1988): Phosphate rock; *United States Department of the Interior*, Bureau of Mines Phosphate Rock Minerals Yearbook, 15 pages.
- Stowasser, W.E. (1985): Phosphate rock; in *Mineral Facts and Problems*, 1985 Edition, *United States Department of the Interior*, Bureau of Mines Bulletin 675, pages 579-594.
- Telfer, L. (1933): Phosphate in the Canadian Rockies; *The Canadian Mining and Metallurgical Bulletin*-1933, Number 260, pages 566-605.

EVALUATION OF THE FERNIE PHOSPHORITE AND PRINCETON ZEOLITES: POTENTIAL FOR ROCK PHOSPHATE ZEOLITE FERTILIZER USE

By Virginia Marcille-Kerslake

University of Guelph, Ontario

INTRODUCTION

Recently there has been renewed interest in the use of unacidulated ground phosphate rock (also known as rock phosphate) as an alternative to conventional phosphate fertilizers. This has been in response to economic and environmental concerns, the need to develop lower grade deposits, and the growing trend toward low-input agriculture.

Unfortunately, the effectiveness of rock phosphate is limited by its low solubility under most soil conditions. In light of this problem, Dennis Eberl and Tung-Ming Lai of the United States Geological Survey introduced the use of natural zeolites to increase the solubility of rock phosphate by acting as a cation exchanger.

Both resources needed for this system are present in British Columbia. Zeolites occur in the Princeton basin in south-central British Columbia, while sedimentary phosphate rock occurs in the southeast in the Fernie basin. Research for the author's M.Sc. thesis involved characterizing these resources and evaluating their suitability for use as a zeolite - rock phosphate fertilizer (Marcille-Kerslake, 1991). The following is a summary of that research.

BACKGROUND INFORMATION ON ZEOLITES

Classified as framework silicates, the minerals belonging to the zeolite group are composed of tetrahedra of oxygen with a silicon (or substituting ion) at the centre of each. The silica tetrahedra form interconnected rings which are arranged such that an open network of channels and cavities exists within the crystal structure. The size of the channels is different for each zeolite, and ranges from 3 to 8 Angstroms in diameter (Parham, 1989).

Without substitution, the silicon:oxygen ratio would be 1:2 and the charge would be neutral. However, isomorphic substitution of Al^{3+} for Si^{4+} imparts a negative charge on the crystal framework. In order to maintain electrostatic balance, hydrated cations are loosely held on the internal and external surfaces of the zeolite. These cations, commonly sodium, potassium, calcium and magnesium, are easily exchanged for other monovalent and divalent cations which enter the crystal structure.

This unique crystal structure results in a number of potentially useful chemical and physical properties:

- low density (2.1 to 2.2g/cm³)
- high void volume (up to 50%)
- large surface area
- molecular sieve properties
- high cation exchange capacity (200 to 300 cmol+ /kg)

- preferential adsorption of certain cations
- high water-holding capacity (10 to 20 % of mass)
- affinity for polar molecules

The uses for natural zeolites which have the best potential are in the fields of aquaculture, agriculture, industry, construction, waste management and domestic uses. In 1980, global production of natural zeolites amounted to only 270 000 tonnes, the majority of which was used in the construction industry. The current on-site price for zeolites from Teague Minerals in Oregon on a truckload basis is US \$85 per ton. Transport costs vary depending on distance, but typically range from US\$ 0.55 to 1.60 per tonne per 10 miles (Dave Leppart, personal communication).

At present the natural zeolite market is at a stalemate. In order to improve the situation, a better understanding of zeolites and their associated properties needs to be developed, and this technology must be sold with the product (Mumpton, 1988).

PRINCETON BASIN ZEOLITES

In 1986, a study conducted by the province of British Columbia reported the presence of zeolite in five distinct locations in the Allenby Formation in the Princeton basin: Sunday Creek tephra, Snowpatch ash, Asp Creek ash, Tailings ash and Bromley Vale tephra (Read, 1987). These layers range from 7 to 22 metres in thickness.

For this research, samples were collected at 1 metre intervals across two Tailings ash sections (VM88-9 and VM88-10) and one Bromley Vale section (VM88-11) (Figure 1). These locations refer to Z7, Z4 and Bromley Vale Adit No.1 in Read's report.

CHARACTERIZATION OF THE PRINCETON ZEOLITES

The samples were characterized with respect to mineralogy, geochemistry, exchangeable cations, cation exchange capacity (CEC) and scanning electron microscope analysis. Because there is not yet a universal methodology for determining the CEC of zeolites three of the more appropriate and widely used methodologies were used for the sake of comparison. (For a more detailed description of the analytical procedures followed see Marcille, 1988, and Marcille-Kerslake, 1991).

The zeolite content was estimated from the CEC value for each sample according to the following equation:

$$\text{Zeolite Content (\%)} = \frac{\text{CEC (cmol+ /kg)} \times 100}{220 \text{ cmol+ /kg}}$$

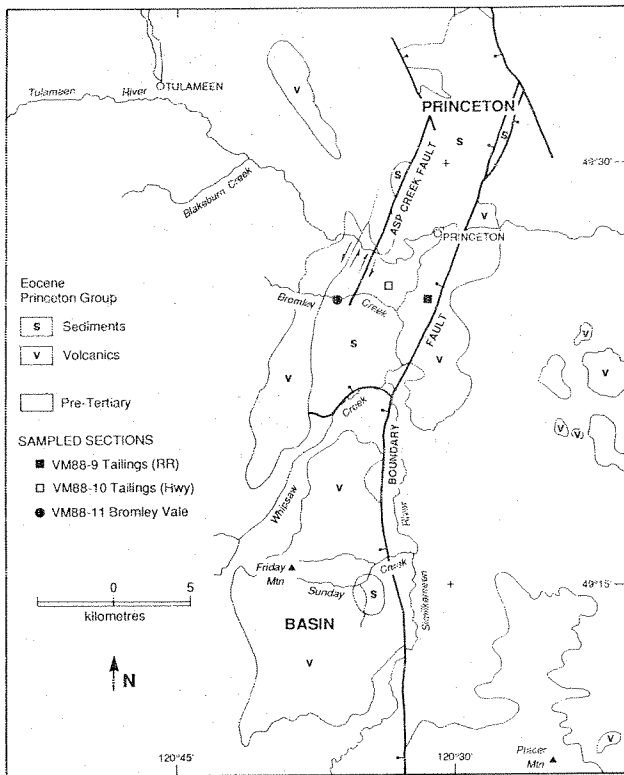

Figure 1. Map of the Princeton Basin showing site locations (modified from Read, 1987).

It was necessary to assume, therefore, that the CEC of a pure clinoptilolite is 220 cmol+/kg and that the contributions of accessory minerals to the CEC are negligible.

According to x-ray diffraction analysis, zeolite is present in all of the samples and this zeolite is clinoptilolite. The accessory minerals include plagioclase and potassium feldspars, quartz, and trace amounts of mica and expandable clay minerals.

The presence of clinoptilolite was confirmed by observation under the scanning electron microscope. As illustrated by Plate 1, the samples contain a large proportion of coffin-shaped crystal, typical of clinoptilolite.

For all three sites, the predominant exchangeable cation is potassium, followed by calcium, sodium and finally magnesium. If the zeolite is to be used untreated as a soil amendment, large amounts of exchangeable sodium may be of concern. VM88-10 contains the greatest proportion (36.5%) of exchangeable sodium.

The zeolite content of the samples ranges from 22 to 77 per cent. Figure 2 illustrates the zeolite content at 1 metre intervals across each section. VM88-9 has the highest average (67%) and the least variability.

BACKGROUND INFORMATION ON PHOSPHATE ROCK

The world phosphate industry is supplied by three types of phosphate sources: deposits of igneous rock origin, or sedimentary rock origin, and guano derivatives. Sedimentary phosphate rock, which accounts for 80 per

cent of total phosphate resources, is the focus of this research and current commercial activity.

The most abundant phosphate minerals belong to the apatite series. The end members of this series are chlorapatite $[\text{Ca}_{10}(\text{PO}_4)_6\text{Cl}_2]$, fluorapatite $[\text{Ca}_{10}(\text{PO}_4)_6\text{F}_2]$ and hydroxyapatite $[\text{Ca}_{10}(\text{PO}_4)_6(\text{OH})_2]$. Francolite, the apatite most commonly found in sedimentary phosphate rock, is similar to fluorapatite, but has different properties and composition due to isomorphous substitution. Of these substitutions, the most significant is that of CO_3^{2-} for PO_4^{3-} . The resulting general formula for francolite contains sodium and supplemental fluorine to balance the positive charge generated by the carbonate substitution:

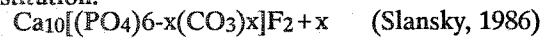

The solubility of an apatite is directly proportional to the degree of carbonate substitution. This is extremely important if the phosphate rock is to be used for direct application to soils as rock phosphate: Although it is only one factor affecting its relative agronomic effectiveness (RAE), the solubility of the apatite shows a strong correlation with both crop yield and plant uptake of phosphorus for the first crop growth (IFDC, 1979). Therefore, a high solubility and, therefore, a high degree of carbonate substitution in the apatite is desirable.

One of the most reliable means of predicting the solubility of an apatite is to measure its unit-cell parameter a . The value of parameter a is inversely proportional to the molar ratio of CO_3/PO_4 . (It is generally agreed upon that this effect can be attributed to the shorter distance between the oxygen atoms in the carbonate ions than in the phosphate tetrahedra, Slansky, 1986). Therefore, the smaller the parameter a value, the greater the degree of carbonate substitution, and hence, the more soluble the apatite.

Ninety per cent of the phosphate rock that is mined is used to produce chemically-processed phosphate fertilizers. Currently the supply outweighs the demand and, as a result, prices are relatively low and high grade ores are available. However, this is expected to change in the

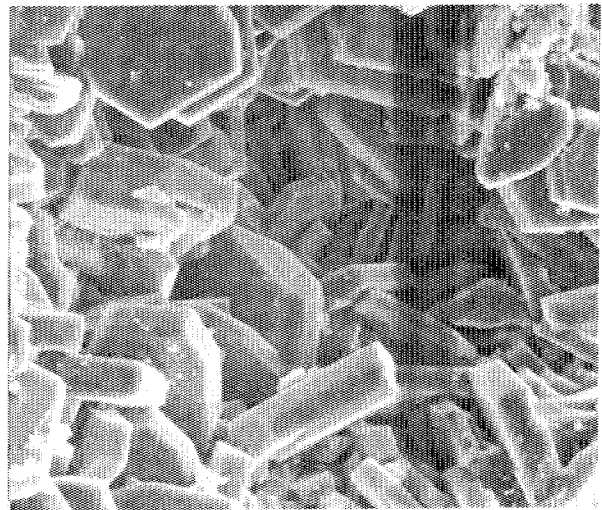

Plate 1. SEM image of VM88-9 at 1000 X magnification.

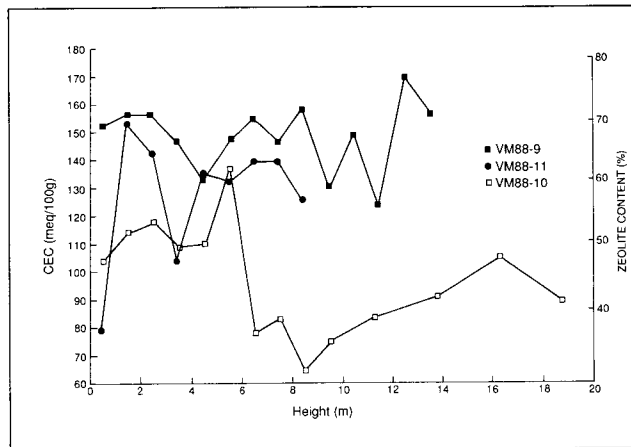

Figure 2. Zeolite content across sampled sections as estimated from CEC.

near future as global demand increases and the major Florida deposit nears depletion.

Canada currently produces no phosphate rock, and imports 100 per cent of its supply from the United States. This supply is secure until the year 2000 at which time Canada will need to secure a new supplier or develop our own resources.

FERNIE BASIN PHOSPHORITE

In 1987, a province-wide inventory of phosphate rock resources reported that the best potential for development lies at the base of the Fernie Formation in the Fernie basin of southeastern British Columbia (Butrenchuk, 1987).

This pelletal phosphorite bed is 1 to 2 metres thick and averages 20 per cent P_2O_5 . Pellets of apatite and organic matter comprise 50 to 85 per cent of the rock. There is an estimated 57 to 340 million tonnes of phosphate rock of which 60 per cent and the highest grades lie in British Columbia, the rest in Alberta.

Seven exposures of the basal Fernie phosphorite were selected for this research. They are VM89-1, 2, 3, 4, 5, 7 and 8 (Figure 3) and correspond to the following in the Butrenchuk study: Highway 3, Alexander, Crow, Abby, Bingay, Bighorn and Cabin.

CHARACTERIZATION OF THE FERNIE PHOSPHORITE

The samples were characterized with respect to mineralogy, geochemistry and solubility. The solubility was predicted using the unit *a*-cell value, fluorine content, and by chemical extraction using neutral ammonium citrate. The unit *a*-cell and *c*-cell values were calculated from the x-ray diffraction data. (For a more detailed description of the analytical procedures refer to Marcille-Kerslake, 1989 and 1991).

According to x-ray diffraction analysis, apatite is present in all of the samples, as are quartz and minor amounts of feldspar. Calcite is a minor constituent of VM89-1 to VM89-4 (*i.e.* Highway 3, Alexander, Crow and Abby), and dolomite occurs in trace amounts in VM89-1 and VM89-2.

The parameter *a* and *c* values for the samples fell

within the range defined for francolite (*i.e.* 9.322 to 9.376 Angstroms and 6.877 to 6.900 Angstroms, respectively; McClennan and Gremillion, 1980), with the exception of VM89-1 which is a fluorohydroxyapatite (Table 1).

To be accepted by fertilizer processing plants in Canada, the geochemical composition of a phosphate rock must meet the following standards (Butrenchuk, 1987):

- P_2O_5 : 27 to 42 per cent
- CaO/ P_2O_5 : 1.32 to 1.60
- R_2O_3/P_2O_5 : less than 0.1
- MgO: less than 1.0 per cent

Based on the results of geochemical analysis performed using two different techniques (x-ray fluorescence and wet chemistry), the Fernie basin phosphorite would meet these standards. However, Highway 3, Bingay, Bighorn and Cabin would require beneficiation, particularly Highway 3.

Using an electron microprobe, it was possible to obtain a geochemical analysis of individual points within a sample, most significantly, of points within the apatite-rich pellets. The results of this analysis are typical of francolite. Furthermore, the F/ P_2O_5 ratio indicates an intermediate degree of carbonate substitution.

The degree of carbonate substitution was also estimated from the *a*-cell value using the following formula:

$$x/x-6 = 4.90 (9.374-a)$$

such that, *a* is the parameter *a* value (in angstroms)

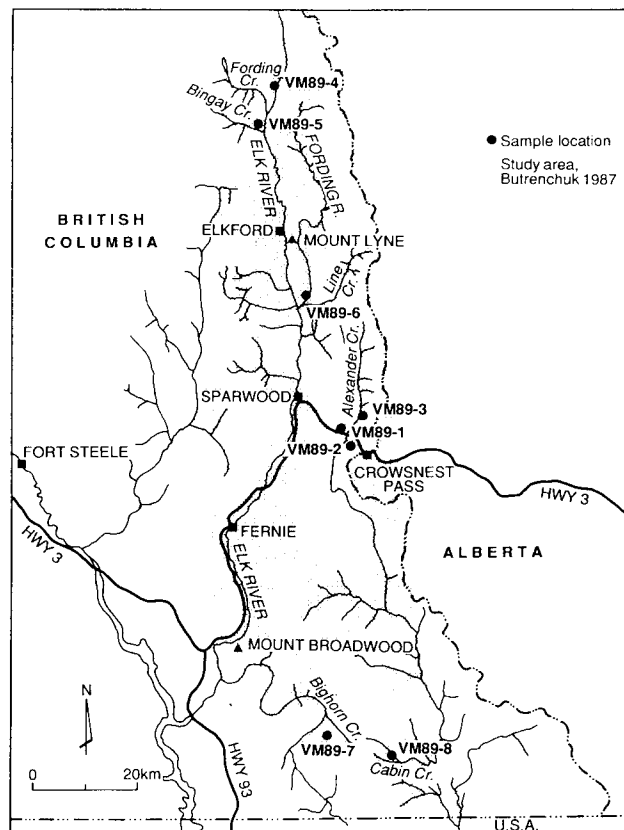

Figure 3. Map of the Fernie Basin showing site locations (modified from Butrenchuk, 1987).

TABLE 1
CRYSTAL PARAMETER VALUES AND
CORRESPONDING APATITE FOR FERNIE
PHOSPHORITE SAMPLES

Sample	a (Å°)	c (Å°)	Apatite
VM89-1	9.3773	6.900	F-hydroxyapatite
VM89-2	9.3557	6.8927	francolite
VM89-3	9.365	6.900	francolite
VM89-4	9.341	6.875	francolite
VM89-5	9.372	6.894	francolite
VM89-7	9.3655	6.8995	francolite
VM89-8	9.364	6.8997	francolite

and $x/6-x$ is the mole ratio of $\text{CO}_3^{2-}:\text{PO}_4^{3-}$. In most sedimentary apatites the value of $\text{CO}_3^{2-}/\text{PO}_4^{3-}$ ranges from 0.071 to 0.304. Once again, the results for the Fernie phosphorite samples indicate a low to intermediate degree of carbonate substitution (Table 2) relative to other francolites. In other words, the basal Fernie phosphorite contains francolite of low to moderate reactivity.

BACKGROUND INFORMATION ON ROCK PHOSPHATE ZEOLITE FERTILIZER

Rock phosphate has several advantages over conventional phosphate fertilizers. It is less expensive, requires minimal processing and can make use of lower grade ores. Under certain acidic soil conditions, it may be a more efficient source of P for crops than superphosphate fertilizers.

The breakdown of apatite in rock phosphate can be represented by the following forward reaction:

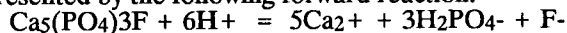

As the forward reaction proceeds, phosphate is released into solution and becomes available to plants. By the law of mass action, this reaction increases as the

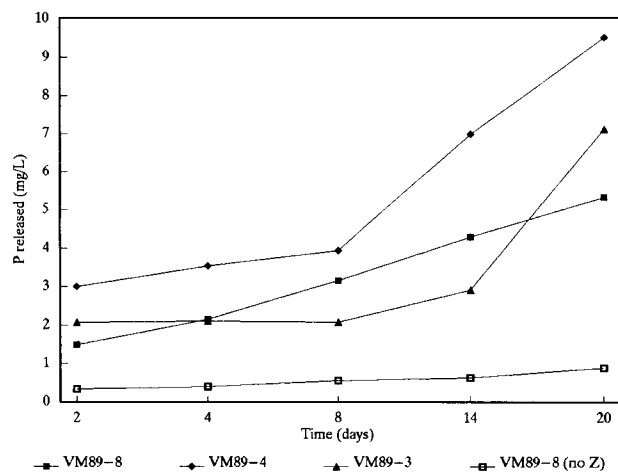

Figure 4. Phosphorous released from various phosphate rocks over time with and without zeolite.

TABLE 2
DEGREE OF CARBONATE SUBSTITUTION IN
APATITE FOR FERNIE PHOSPHORITE SAMPLES
BASED ON PARAMETER A VALUES

Sample	Parameter a (Å°)	$\text{CO}_3:\text{PO}_4$
VM89-1	9.377	*
VM89-2	9.356	0.0882
VM89-3	9.365	0.0441
VM89-4	9.341	0.1617
VM89-5	9.372	0.0098
VM89-7	9.366	0.0392
VM89-8	9.364	0.0492

pH decreases. Similarly, the accumulation of reaction products inhibits apatite dissolution.

In theory, when zeolite is added to this system it removes Ca^{2+} , thereby increasing the rate of apatite dissolution and the subsequent supply of P to plants. In addition to increasing phosphorus, the zeolite can be modified to supply additional nutrients. As calcium is adsorbed by the zeolite, the original exchangeable cations (K^+ , Mg^{2+} , Na^+ , etc.) are released into solution. Therefore, by presaturating the exchange sites with NH_4^+ or K^+ , the zeolite becomes a slow-release fertilizer of these nutrients.

CONTROLLED DISSOLUTION STUDIES

Controlled dissolution studies were conducted to determine how the effectiveness of the system could be increased. In these studies, ground Fernie phosphorite and Princeton zeolite were shaken in deionized water and, after various time intervals, the concentration of dissolved phosphorus was measured. (For a more complete description of these experiments, see Marcille-Kerslake 1989, and 1991).

It was concluded from these studies that the rate of dissolution of the rock phosphate was increased by the addition of zeolite. Furthermore, the effectiveness of the zeolite was increased by presaturating the exchange sites with a single monovalent cation (NH_4^+), and increased with increasing grain size from 53 micrometres to 1.0

TABLE 3
CONCENTRATION OF NaHCO_3 -EXTRACTABLE P
IN SOIL #1 AND SOIL #2 TREATMENTS AFTER 3
SOYBEAN CROPS

Fertilizer	NaHCO_3 -extractable P (mg/kg)	
	Soil #1	Soil #2
MCP	36	43
PR	10	16
2Z:1PR	12	16
4Z:1PR	14	16
6Z:1PR	15	16
No P	10	15

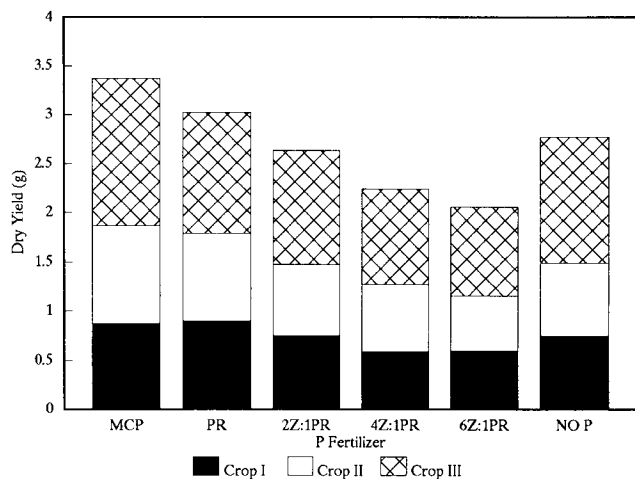

Figure 5. Dry yield versus fertilizer treatment for soybean Crops I, II and III grown on Soil #1.

millimetres. This direct relationship between grain size and zeolite effectiveness was contrary to prior expectations: It was expected that smaller grain sizes would be more effective due to their increased surface areas. It was concluded that grinding the samples may destroy some of the internal network of voids, thereby reducing the zeolites' exchange capacity.

The magnitude of the zeolite's effect on rock phosphate dissolution is illustrated in Figure 4, in which the amount of phosphorus released into solution is plotted against time for various systems. Using VM89-8 as an example, the concentration of dissolved P after 20 days for the phosphate rock alone (hollow squares) was only 0.9 milligrams per litre compared to 5.3 milligrams per litre when zeolite was added (solid squares). This is a six-fold increase in solubility.

Furthermore, according to this dissolution study the order of the phosphate rocks from most to least reactive is: VM89-3, VM89-4 and VM89-8 (Figure 4). This is the same order as predicted by the parameter a values.

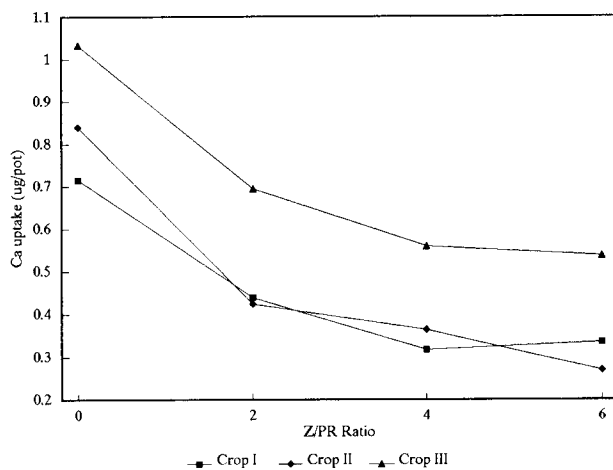

Figure 7. Ca uptake by soybean plants versus Z/PR ratio Crops I, II and III grown on Soil #1.

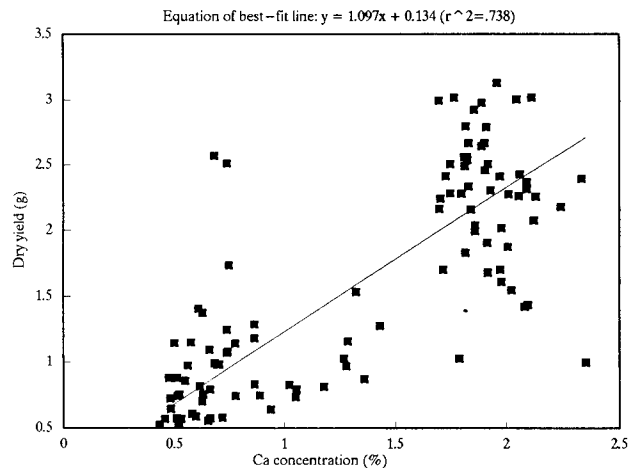

Figure 6. Dry yield versus Ca concentration in plant tissue for Crops I, II and III on Soil #1 and Soil #2.

GREENHOUSE EXPERIMENT

The final phase of this research was to test the system in a greenhouse pot trial experiment. Two soils were used: Soil #1 was an acid soil from central Ontario with an inherently low fertility. By contrast, Soil #2 had a neutral pH, and high fertility with extremely high Ca content. Soil #2 was purposely chosen for its unsuitability for rock phosphate application. Six fertilizer treatments were used: monocalcium phosphate (MCP); four phosphate rock fertilizers with zeolite/phosphate rock (Z/PR) ratios of 0, 2, 4 and 6; and a control in which no P was applied. Each treatment (Soil + P fertilizer) was replicated three times.

Three successive soybean crops were grown in each pot. The only fertilizer applied was phosphorus, and this was applied only at the start of the first crop. Soil #1 received 250 milligrams per kilogram of P and Soil #2 received 150 milligrams per kilogram (as either MCP or phosphate rock fertilizer). At the end of each crop, the dry matter yields were measured and the nutrient concentrations in the plant tissue were analysed. At the end of the third crop, the concentration of plant-available phosphorus remaining in the soil was also measured by sodium bicarbonate extraction.

For both soils, the concentration of plant-available phosphorus at the end of the experiment had not changed from its original value, and only a small portion of the MCP-phosphorus had been consumed by the plant (Table 3). This suggests, unfortunately, that P was not the limiting factor to plant growth in this experiment.

As expected, on the calcareous soil (Soil #2) PR dissolution was minimal and the zeolite had no effect on the concentration of plant-available P (Table 3). On the acid soil, however, there was a clear increase in PR dissolution with increasing zeolite content.

For all three crops grown on the acid soil, crop response was best for MCP and PR alone, followed by the control, and finally, the zeolite + PR treatments. The dry matter yields for Crops I, II and III grown on Soil #1 show a steady and consistent decrease as zeolite content increases (Figure 5).

The explanation for this unexpected negative crop response to zeolite was found through nutrient analysis

of the plant tissue. In Figure 6, the dry matter yield has been plotted against the calcium concentration in the plant tissue for every replicate of each treatment (Fertilizer + Soil) over Crops I, II and III. There is a strong correlation between the two variables.

For all three crops grown on the acid soil (Soil #1), the MCP and PR treatments supplied adequate amounts of calcium to the plants, the control (No P) had marginal to adequate amounts, and there was calcium deficiency in the Z+PR treatments. Furthermore, Ca uptake decreased with increasing zeolite content, as illustrated in Figure 7.

Therefore, in addition to adsorbing calcium from the phosphate rock, the zeolite adsorbed calcium from the soil which was inherently low in calcium, and thereby lead to an induced calcium deficiency in the plants.

GENERAL CONCLUSIONS

In conclusion, while the zeolite - phosphate rock fertilizer is not a blanket solution, it may provide an alternative to conventional phosphate fertilizers under conditions favourable to its use. That is, the soil should be acidic and have a relatively low calcium content, and crops with low calcium requirements are desirable. In addition to soil and crop considerations, the use of this system should be preceded by a complete characterization of the zeolite and phosphate rock to ensure their appropriate use. Further studies to test the zeolite - phosphate rock fertilizer on a wide range of soil types, and long-term field trials are needed.

REFERENCES

- Butrenchuk S.B. (1987): Phosphate in South Eastern British Columbia; *B.C. Ministry of Energy, Mines and Petroleum Resources*, Open File 1987-16, 103 pages.
- International Fertilizer Development Centre (IFDC) (1979): Fertilizer Manual. Reference Manual IFDC-R-1. International Fertilizer Development Corporation. Muscle Shoals, Alabama. Pages 149-154.
- Marcille V. (1989): Industrial Zeolites in the Princeton Basin; *B.C. Ministry of Energy, Mines and Petroleum Resources*, Geological Fieldwork 1988.
- Marcille-Kerslake V. (1990): Sedimentary Phosphates in the Fernie Basin: Development of New Technology for Direct Application to Soils; *B.C. Ministry of Energy, Mines and Petroleum Resources*, Geological Fieldwork 1989.
- Marcille, Kerslake, V. (1991): Evaluation of the Fernie Phosphorite and Princeton Zeolites: Potential for Rock Phosphate-Zeolite fertilizer use; M.Sc. thesis, *University of Guelph*.
- McClennan, G.H. and L.R. Gremillion (1980): Evaluation of Phosphatic Raw Materials; in *The Role of Phosphorus in Agriculture, Agronomics Society of America - Crop Science Society of America - Soil Science Society of America*, Madison, Wisconsin, pages 43 to 80.
- Mumpton, F.A. (1988): Development of uses for natural zeolites: A Critical Commentary; in D. Kallo and H.S. Sherry, eds., Occurrences, properties and, utilization of natural zeolites, *Akademia Kiado*, Budapest.
- Parham W. (1989): Natural Zeolites: Some Potential Agricultural Applications for Developing Countries; *Natural Resources Forum*, May 1989, page 107-115.
- Read P.B. (1987): Industrial minerals in some Tertiary basins, southern British Columbia (92H, 92I); *B.C. Ministry of Energy, Mines and Petroleum Resources*, Geological Fieldwork 1986, Paper 1987-1, pages 247-254.
- Slansky M. (1986): Geology of Sedimentary Phosphates; *Elsevier Science Publishing Co. Inc.*, New York, 210 pages.

A MASSIVE SKARN-HOSTED ANDRADITE DEPOSIT NEAR PENTICTON, BRITISH COLUMBIA

By H.C. Grond, R. Wolfe, J.H. Montgomery
G.H. Giroux

Polestar Exploration Inc., Vancouver, B.C.
Montgomery Consultants Ltd., Vancouver, B.C.

INTRODUCTION

Garnet is an important industrial mineral. Its high density, angularity, hardness and non-toxicity make it an excellent product for many abrasive applications and other uses. However, currently available garnet products are relatively expensive: Idaho garnet sells for about US \$160-260 per ton FOB minesite. Because of the favourable location, deposit size and high quality garnet content of the Crystal Peak deposit, it is expected that production costs will be low enough to capture a significant share of existing markets as well as allow development of markets previously inaccessible because of garnet's historically high cost.

Crystal Peak Garnet Corporation, a wholly-owned subsidiary of Vancouver-based Polestar Exploration Inc., is in the permitting stage of developing a large, high-grade deposit of skarn-hosted andradite garnet near Penticton, British Columbia. Drilling conducted in 1989 and 1990 indicated 40 million tonnes of about 80 per cent garnet in three zones, with additional geological reserves of 60 million tonnes. Detailed drilling in the proposed pit area has defined 3.35 million tonnes of 81.3 per cent garnet.

The deposit has excellent potential for development. Elevations are moderate, ranging from 1900 to 2100 metres above sea level. Road access and power lines are already in place because of nearby mining and recreational developments. All supplies, facilities and manpower requirements are available in the nearby communities of Penticton and Keremeos.

Capital pre-production costs are estimated at approximately 3 million dollars. The construction phase of the project, scheduled for June 1991 (depending on permitting), is estimated to require six months to complete.

The Crystal Peak deposit is larger and of higher grade than any garnet deposit currently mined anywhere in the world. At the proposed operating rate of 60 000 tonnes per year, it is expected the Crystal Peak deposit will be the world's largest producer.

GEOLOGICAL SETTING

The Crystal Peak deposit includes much of Mt. Riordan and is within the Intermontane Belt of the Canadian Cordillera. The major rock units in the area are part of the Late Triassic Nicola Group. The Nicola Group rocks are intruded by the Early Jurassic Bromley batholith and Cahill Creek pluton.

The Crystal Peak skarn deposit is the most easterly of a series of skarns which includes those at the presently operating Nickel Plate Mine and the old French and Goodhope mines. The composition of the skarns varies from low garnet with high arsenic and gold in the west to high garnet with low gold and no arsenic in the east at Crystal Peak (Ray and Dawson, 1988; Ray *et al.*, 1988).

The Crystal Peak garnet deposit is unusual because of its large size and high grade (most commercial garnet deposits average 20% garnet or less). The surface extent of the garnet body is 300 by 800 metres, including three major zones of particularly high grade (78% garnet) - the North, South, and West Zones. Cliff exposure and drilling results indicate high grade garnet at considerable depths: one drill hole intersected high grade garnet to a depth of 200 metres. Replacement of limestone by garnet is almost complete: only one small limestone lens was observed in drill core (Grond and Wolfe, 1991). Diopside (clinopyroxene) is the most common accessory mineral. In most cases, the diopside has been partially altered to actinolite, sericite and epidote. Quartz, epidote and occasionally sphene occur in relatively low quantities. Calcite content is also relatively low; it occurs in small veins near the top of Mt. Riordan and as interstitial blebs up to 3 centimetres across. Magnetite, hematite and various sulphides including pyrite, pyrrhotite and chalcopyrite (rare) occur in very minor amounts throughout the deposit. Average values for accessory minerals in the North Zone deposit are as follows:

Diopside	10.94%
Quartz	2.46%
Calcite	1.83%
Actinolite, epidote, sericite	4.67%
Feldspar	.03%
Sphene	.064%
Apatite	.06%
Opaque	.44% (magnetite and minor sulphides)

Garnet occurs as massive garnetite or coarsely crystalline aggregates, locally showing growth zonation. Red-brown, green, and pink-orange are the most common colours although buff and black varieties have been noted.

Microprobe analyses show the garnet to be about 90 per cent andradite ($\text{Ca}_3\text{Fe}_2\text{Si}_3\text{O}_{12}$) and 10 per cent grossularite ($\text{Ca}_3\text{Al}_2\text{Si}_3\text{O}_{12}$). Andradite and grossularite form a solid solution series with iron and aluminum being interchangeable. To a lesser extent manganese or magnesium can substitute for calcium. A granodiorite contact at the eastern edge of the skarn is well exposed. In addition, small diorite remnants are scattered in a broad zone through the centre of the skarn. The diorite remnants had some influence on skarn formation: samples of adjacent massive garnetite rock have distinct relict intrusive textures.

GRADE DETERMINATION

Since garnet content cannot be determined by conventional assay techniques, different methods were employed. Both visual estimates and thin section analyses were used to estimate garnet content in the drill core and

532 representative samples were selected for thin section analyses during core logging. In general, thin section analyses corresponded remarkably well with visual estimates.

Two additional methods of grade determination were employed to check results - thin section analyses of crushed mixed core, and heavy liquid separation. All methods correlated well and final results were judged to be accurate within 1 or 2 per cent.

RESERVE CALCULATIONS

Reserve values for the entire deposit have been generated based on average garnet content in drill holes. Surface dimensions were derived by results of detailed surface sampling and mapping to outline exposed areas of high grade garnet-bearing rock. An average specific gravity of 3.5 was used to determine tonnage.

A reserve total of approximately 40 million tonnes of about 80 per cent garnet was calculated based on depths of less than 10 metres. An additional 60 million tonnes of possible geological reserves are indicated. This is based principally on extending the deposit to depth, as drill hole data and cliff exposures indicate that the deposit is much deeper than the cut-off depths used in the calculations.

Detailed reserve calculations have been made for the proposed quarry in the North Zone (Giroux, 1991). Semi-variogram analysis indicates an isotropic structure for garnet, with a horizontal range of 120 metres. The nugget effect is less than 10 per cent of the sill value so estimation errors are relatively low.

Blocks 20 by 20 by 5 metres were estimated by ordinary kriging and indicate reserves in the North Zone of 3.35 million tonnes averaging 81.3 per cent garnet at a 64 per cent garnet cutoff between the 2 025 and 2 085 metre levels. The current pit outline in this zone contains 1.93 million tonnes of 80 per cent garnet or 25 years production at 75 000 tonnes per year (60 000 tonnes finished product).

MARKETING

Current world production of garnet is estimated at 100 000 tonnes annually, with North American production being about 50 000 tonnes produced from two mines - one in New York and the other in Idaho. Other important producers are Australia and India, and recent reports indicate that pilot plant testing is being conducted in Montana and California. North American consumption is estimated at about 46 000 tonnes annually.

Garnet's main applications are:

- Abrasive blast cleaning
- Abrasive waterjet cutting
- Water filtration
- Bonded and coated abrasive products
- High density aggregate
- Wear resistant surfaces

The first four uses listed above probably account for about 90 per cent of North American garnet consumption.

The most promising market for garnet is in abrasive blast cleaning. In North America alone, 5 million tonnes of blasting abrasives are used each year, with west coast consumption estimated to be at least 500 000 tonnes. The

market is currently dominated by silica sand and smelter and coal slags, with garnet consumption being on the order of only 20 000 to 30 000 tonnes. There is a good chance of increasing the market share for garnet at the expense of the silica and slag because of health and environmental considerations. Use of silica sand has been linked to cancer and silicosis, and slags commonly contain toxic heavy metals.

The success in winning a market share for garnet in the abrasive blast cleaning industry has been limited by two factors: relatively high price (averaging about US\$230 per tonne compared to sands and slags costing US\$50-US\$100 per tonne) and limited availability. Despite this, from 1983 to 1988 garnet consumption in all markets increased by 50 per cent in the United States and in the last five years has tripled in the rest of the world.

Strong markets are developing in Japan and Europe for garnet in the blast cleaning industry. This is as a result of health and environmental risks associated with silica sand and slags linked to cancer and silicosis. The use of silica is banned in most European countries and current demand is filled primarily with slags. Extremely high disposal costs are causing consumers to look for alternatives. Garnet is receiving considerable attention for several reasons including its ability to be reused several times in blast cleaning thus reducing disposal costs by reducing the amount of waste produced. An increasingly important market for garnet is in abrasive waterjet cutting. The market for garnet in this sector is increasing at a rate of 30 per cent per year and annual consumption is estimated at 20 000 tonnes. Customers are currently paying between US\$300 and US\$600 per tonne for garnet product. This market is very price sensitive as garnet represents 70 per cent of the hourly operating cost of the process.

Extensive testing of the Crystal Peak garnet products has been done under both laboratory and field conditions. The quality of the product is excellent and it performs very well in both sandblasting and waterjet cutting applications. Continued testing will be carried out for numerous other industrial applications.

Both demand and price forecasts for garnet products are very positive. Given recent growth rates in garnet consumption, it is reasonable to predict the world market could require another 200 000 tonnes annually within five years at the current high prices. If garnet could be sold in the US\$100/tonne range (Crystal Peak Garnet's projected price for sandblasting grit), it is estimated the blast cleaning industry in the western United States alone could consume more than 200 000 tonnes annually.

CONCLUSIONS

Crystal Peak Garnet Corporation is in the permitting stage of developing the largest known, highest grade garnet deposit in the world. The deposit is located near Penticton, British Columbia, and consists of mainly andradite garnet in a skarn zone. Drill indicated reserves total 40 million tonnes of about 80 per cent garnet in three zones, with additional geological reserves of 60 million tonnes. Detailed drilling in the proposed pit area defined 3.35 million tonnes of 81.3 per cent garnet. At the proposed operating rate of 60 000 tonnes per year, it is expected that Crystal Peak could be the world's largest garnet producer.

Garnet is an important industrial mineral with rapidly expanding markets in spite of its currently high price relative to available alternatives. Because of the size and purity of the Crystal Peak deposit, it is expected that production costs will be low enough to capture a significant share of existing markets in the abrasives field as well as allow development of markets previously inaccessible because of garnet's historically high cost.

REFERENCES

Giroux, G.H. (1991): Geostatistical study of the Crystal

Peak Garnet Deposit; *Polestar Exploration Inc. Report*.

Grond, H.C. and Wolfe, R. (1991): Geological and Diamond Drilling Report on the Crystal Peak Garnet Property; *Polestar Exploration Inc. Report*.

Ray, G.E. and Dawson, G.L. (1988): Geology and mineral occurrences in the Hedley Gold Camp; *B.C. Ministry of Energy, Mines and Petroleum Resources, Open File Map 1988-6*.

Ray, G.E., Dawson, G.L. and Simpson, R. (1988): Geology, Geochemistry and Metallogenic zoning in the Hedley Gold-skarn camp; *B.C. Ministry of Energy, Mines, and Petroleum Resources, Fieldwork Paper 1988-1, pages 59 to 80*.

GEOLOGY, MINERALOGY AND PROCESSING OF MOUNT RIORDAN GARNET ORES

By G.I. Mathieu, M.R. Boisclair
R. Wolfe

CANMET, Ottawa, Ontario
Polestar Exploration Inc., Vancouver, BC.

ABSTRACT

An exceptionally large, high-grade garnet skarn deposit has been discovered by Polestar Exploration Inc., on the Crystal Peak property located on Mount Riordan, south-central British Columbia. The deposit outcrops extensively over an area of approximately 800 metres by 300 metres. Three high grade zones averaging almost 80 per cent garnet have been outlined by diamond drilling. Indicated reserves from the 1989 drilling program stand at approximately 40 million tonnes. The three zones, namely, South, West and North have excellent potential for development. Examination of samples from Crystal Peak property has indicated garnets of two main types, namely, (i) one rich in andradite and (ii) the other high in grossularite. POLESTAR has submitted bulk samples to CANMET, which originated from various zones for detailed mineralogy and beneficiation studies. In this paper, we will report the investigation of both the andradite-rich and the grossularite-andradite occurrences. These were characterized with respect to mineral composition, specific gravity, magnetic susceptibility and degree of liberation of the minerals. The data obtained have led to the development and the testing of flowsheets for the beneficiation of the garnet to marketable grade. The processes will be described in detail along with the parameters of operations. An evaluation of the garnet products will be given.

INTRODUCTION

The Mount Riordan garnet skarn deposit is located in the Hedley district, Osoyoos Mining Division, south-central British Columbia. The property is mostly covered by the Apex Recreation area, which was opened to staking on April 17, 1989. During the late summer and fall of 1989, a program of geological mapping and diamond drilling was carried out by Polestar Exploration Inc. on the Crystal Peak prospects on Mount Riordan. The purpose was to outline high grade garnet bodies suitable for open-pit quarrying. Bulk samples were submitted to the Canada Centre for Mining and Energy Technology

(CANMET) for beneficiation studies and flowsheet development.

REGIONAL AND PROPERTY GEOLOGY

The Crystal Peak property lies within the Intermontane Belt of the Canadian Cordillera (Figure 1). The major rock units in the area are members of the Late Triassic Nicola Group which are intruded by Early Jurassic Bromley Batholith and Cahill Creek Pluton. The area was mapped and described in detail by Ray and Dawson (1988). The Mount Riordan deposit is the most easterly of a series of skarns, which includes the presently operating Nickel Plate Mine and the old French and Goodhope mines. The composition of the skarns varies from low garnet with high arsenic and gold in the west to high garnet with low gold and no arsenic in the east (*i.e.*, the Mount Riordan region). This skarn has peculiar features which are summarized in Table 1 (Ray *et al.*, 1988).

The Crystal Peak property consists of 1, 24 unit 1-post claim and 2 reverted crown grants. In addition, 2 single unit claims, the Lake 1 and 2, have been purchased for a potential plant site. Claim information is as in Table 2.

Detailed geological mapping was carried out at a scale of 1:1000 over Mt. Riordan. Outcrop exposure is generally excellent, especially on the boundaries of the garnet body where cliff faces tend to predominate. The main reason for the well developed exposures is the resistive nature of the garnetite. Several low-lying overburden-covered areas were also tested by drilling. These areas tended to consist primarily by metadiorite and sedimentary units.

The "skarnification" or the replacement of limestone by garnet is almost complete. No limestone is found on the property and none of the original sedimentary structures have been preserved. Diopside (a clinopyroxene) is the most common accessory silicate. Quartz, epidote and actinolite occur in relatively low quantities. Calcite con-

TABLE 1
CHARACTERISTICS OF MOUNT RIORDAN SKARN

Skarn mineralogy	Massive, garnet-dominant skarn. Crystalline garnet with highly variable colour.
Degree of skarn overprinting	No sedimentary structures preserved.
Skarn metallogeny	W, Cu, Ag
Skarn-related intrusions	Associated with I-Type granodiorites that do not resemble the Hedley intrusions.
District hostrock geology	Massive limestone

tent is also relatively low, occurring in small veins near the top of the mountain and occasionally as interstitial blebs 1.3 millimetres across.

Garnet occurs either as massive garnetite or is coarsely crystalline, often showing growth zonation. The garnet minerals are andradite and grossularite. Red-brown, green, and pink-orange are the most common colours, although buff and black varieties have been noted.

Relative to other garnet-rich skarns, this deposit appears to be very large. Garnet-rich outcrop occurs intermittently over an area 800 metres by 300 metres.

Diamond drilling indicates that the garnet zone has a minimum depth of 300 metres. This is based on the distance between the uppermost exposure of garnet at the peak to the lowest intersection of garnet in the deepest hole. In areas of almost continuous outcrop, three major high-grade zones (60% to 100% garnet) occur. These areas are identified as the North, South and West zones in Figure 2, which also shows the 23 drill holes of the exploration programs (Grond and Wolfe, 1990).

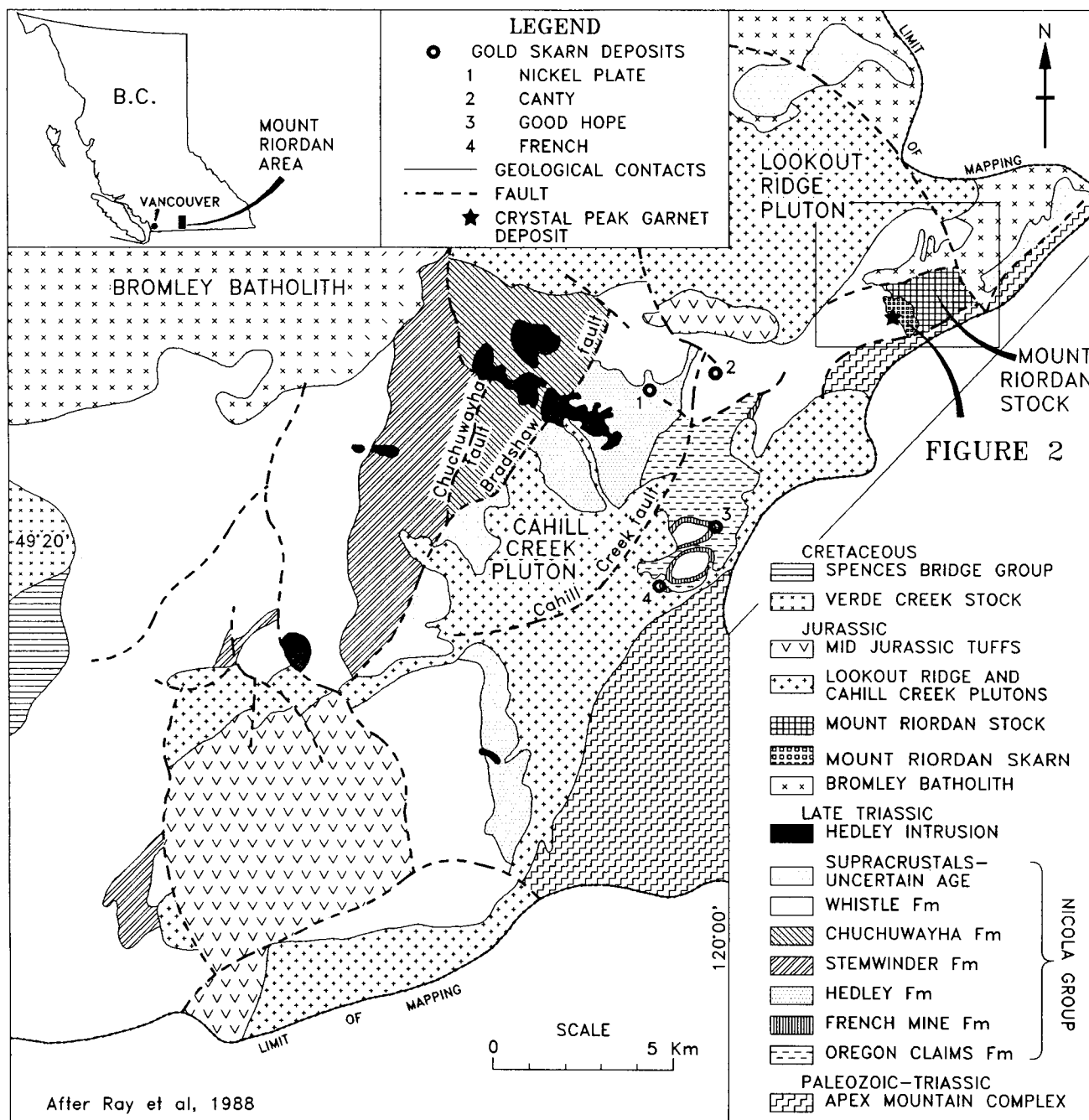

Figure 1. Regional geology.

TABLE 2
CLAIMS OF CRYSTAL PEAK PROPERTY

Type	Name	No. of Units or Acreage	Recording Date
Located	KE8674	24 Units	April 18, 1989
Crown-Granted	Billy Goat (L3122)	34.62 Acres	Sept. 15, 1898
Crown-Granted	Shamrock (L3123)	10.54 Acres	July 13, 1899
Located	Lake 1 (797)	1 Unit	July 30, 1979
Located	Lake 2 (798)	1 Unit	July 30, 1979

DIAMOND DRILLING, RESERVES AND MINERAL CONTENT

A total of 1 020 metres were drilled in 23 holes. Out of these, 17 hit high-grade garnet in the North, West and East zones. Reserves were calculated by multiplying the average garnet content by the drill core length and the surface dimensions outlining high-grade garnet-bearing rock, and assuming a density of 3.5 tonnes per cubic metre, as shown in Table 3.

Variation has been noted between the main zones. In particular, the South zone garnetite varies significantly from the North and West zones which are similar. The garnet in the South zone is generally coarsely crystalline (up to 1 cm) and has a distinctive pink-orange or salmon colour. The garnetite is exposed in a series of cliffs up to 250 metres high on the southern boundary of the deposit. The most common accessory mineral is coarse-grained radiating actinolite crystals up to 5 centimetres long. A 3 to 5 metre wide band of massive calcite/epidote, trending roughly east occurs just south of Drill hole No. 10. The North and West zones consist primarily of dark green garnet which is extremely variable in grain size. Coarse garnet is often intimately associated with very fine-grained garnet giving a "blotchy effect". The most common accessory mineral is diopside; it generally occurs in patches that can grade up to 100 per cent. Microprobe analyses of drill samples made at The University of British Columbia show the garnet to be composed of about 90 per cent andradite ($\text{Ca}_3\text{Fe}_2\text{Si}_3\text{O}_{12}$) and 10 per cent grossularite ($\text{Ca}_3\text{Al}_2\text{Si}_3\text{O}_{12}$). It was also observed that the garnet-crystal cores tend to be high in andradite, whereas the margins are higher in grossularite. Bulk samples were collected from the South and West zones of the property. In the South zone, representative sam-

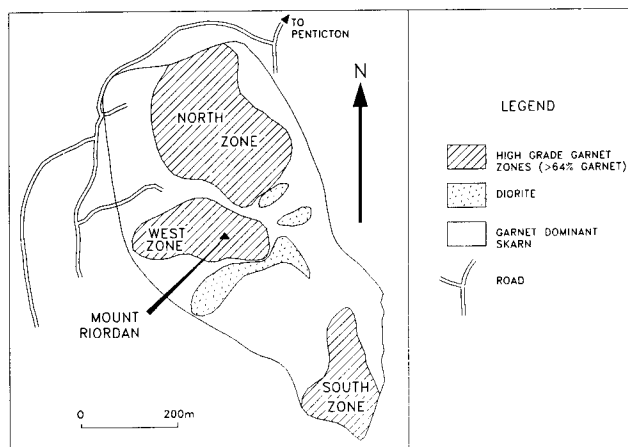

Figure 2. Idealized geology and diamond drill holes.

ples were picked from the large talus slopes beneath the garnetiferous cliffs. In the West zone, the samples were collected from each of three blasted pits identified as W1, W2 and W3. A total of 8 tonnes of material was shipped to CANMET laboratories in Ottawa for characterization and beneficiation. Two of the samples, namely, W1 and W3 were typical of an andradite-rich section and of a mixed andradite-grossularite section. CANMET's main efforts were directed at investigating these two types of occurrences.

CHARACTERIZATION OF GARNET SAMPLES

SPECIFIC GRAVITY

Several pails of W1 and W3 samples were opened and the pieces examined visually. Each garnet lot had a distinct colour, (e.g., greenish brown for W1 and yellow for W3). Ten specimens were selected from each sample and specific gravity was determined piece by piece. Small but significant differences between the two lots were observed, as indicated in Table 4 and represented graphically in Figure 3.

The high specific gravities of the W1 specimens confirm a rich andradite (SG=3.75) zone, while the presence of grossularite (SG=3.53) is responsible for the lower specific gravities of the W3 samples.

Pure andradite and grossularite have specific gravities of 3.75 and 3.53, therefore, it is inferred that the two ore lots contain high-grade garnets.

MINERALOGY

Several pails of each lot were crushed to minus 1

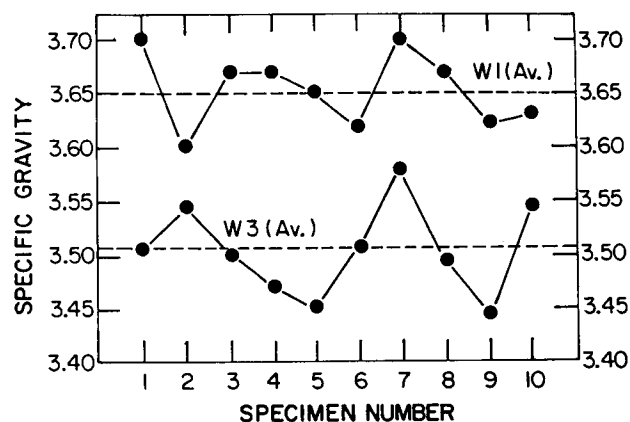

Figure 3. Range of specific gravity of W1 and W3 garnet specimens.

TABLE 3
ESTIMATION OF GARNET TONNAGE AND GRADE IN NORTH, WEST AND SOUTH ZONES

Zone	Average Garnet Grade	Approximate Surface Area in Metres	Depth in Metres	Drill Indicated Reserves (Million tonnes)
North	80 %	350 x 200	73	17.8
West	78 %	300 x 124	91	11.8
South	77 %	270 x 124	91	10.7

centimetre from which chips were selected and submitted to our Mineralogy Section for identification of the major minerals and garnet species, determination of the approximate modal composition, and estimation of liberation size. The methods used for the mineralogical examination were: (i) x-ray diffractometry of pulverized material to identify the minerals and, (ii) SME-IPS Image Analysis System of polished sections (plus EDX) to determine mineral quantities and grain size distribution of the garnet species. Table 5 shows the major and minor minerals identified, and their relative abundance in each sample.

The EDX spectra showed that the andradite particles have a variable iron and aluminum content displayed as zoning in some grains. In sample W1, the iron content corresponds to a garnet composition close to the left end corner of the diagram of Figure 4 (*i.e.*, relatively "pure" andradite). On the other hand, the aluminum content of sample W3 resulted in a diffractometer pattern shifted nearly halfway towards the end member grossularite.

CANMET's findings were in agreement with those of other investigators. Of 32 samples analyzed by Myra Keep at The University of British Columbia, 27 have garnet with an andradite component greater than 65 per cent and 5 samples have a high grossularite content. Compositional variation of either andradite or grossularite from the cores to the rims of the grains were also reported by this investigator (Keep, 1990). Pyroxene is the major impurity in both samples. The grains observed have variable magnesium-iron contents and were not positively identified as diopside or augite; both types have a similar composition as shown in Figure 5. However, the low proportion of magnesium with respect to iron indicates a likely ferroan augite.

GRAIN SIZE AND LIBERATION

Grain-size analysis of each sample of garnet were made by microscope. Distributions of the garnet grains were obtained and are summarized in Table 6.

The size analysis indicated that a 95 per cent liberation would require grinding W1 and W3 samples to 80

TABLE 4
SPECIFIC GRAVITY OF GARNET SPECIMENS FROM W1 AND W3

W1:	3.70, 3.60, 3.67, 3.67, 3.65, 3.62, 3.70, 3.67, 3.62, 3.63
W3:	3.51, 3.54, 3.50, 3.47, 3.45, 3.51, 3.61, 3.49, 3.44, 3.54

Average SG: W1 = 3.65 and W3 = 3.51

per cent minus 300 and 106 micrometres, respectively. As this is neither desirable nor practical, we had to accept a partial liberation at -1200 micrometres. This was requested by POLESTAR in order to meet its major commercial target (*i.e.*, the jet sand blasting market).

CRUSHING AND GRINDING OF ORES

Two types of comminution were investigated to reduce the garnet ores from 20 centimetres to minus 1200 micrometres. The first approach used a jaw and a rolls crusher in series, followed by a wet rod mill in closed circuit with a double-deck screen (flowsheet I-A). To prevent overgrinding (*i.e.*, formation of -425 μ m), this circuit was modified with the installation of a second double-deck screen ahead of the rod mill (Flowsheet I-B). Flowsheets I-A and I-B will be referred to as "wet" comminution.

The second size reduction procedure was entirely dry; it involved three successive crushers and two screening set-up (flowsheet II-A). In order to diminish the amount of "fines" produced (-425 μ m), another crusher (gyratory) and set of screens were added to the comminution circuit (flowsheet II-B). Flowsheets II-A and II-B will be referred to as dry comminution.

Figures 6 and 7 illustrate all the flowsheets used for crushing, grinding and classifying the garnet ores.

The end products (-1200 + 425 μ m and -425 μ m) from the process illustrated in flowsheets I-A, I-B, II-A and II-B were weighed. These weights are expressed on a percentage basis in Table 7. The improvement of the results obtained by switching from "wet" to "dry" comminution, and by modifying the two basic flowsheet are illustrated in Figure 8.

TABLE 5
MODAL ANALYSIS OF GARNET SAMPLES

Minerals	W1: Weight %	W3: Weight %
Andradite	90	55
Grossularite	4	35
Pyroxene	5.1	4.7
Calcite	nil	0.01
Apatite	1.4	0.1
Quartz	0.1	0.04
Magnetite, pyrite and hematite	Traces	Traces

*NOTE: The mineral distribution given in this table is only indicative, being obtained from only a few polished sections.

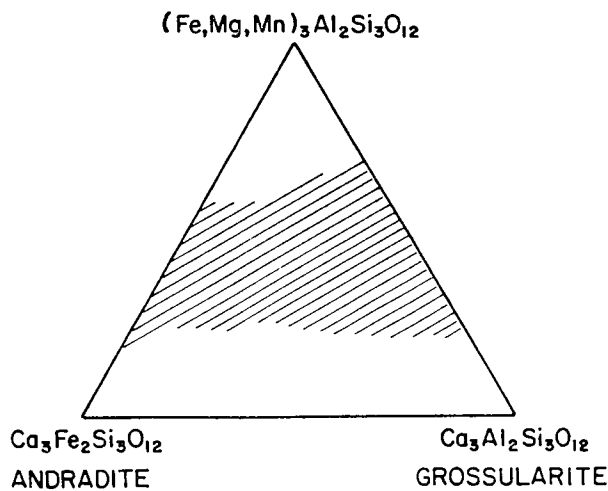

Figure 4. Diagram of mineral composition of garnet.

SAMPLING, HEAD ANALYSES AND DETERMINATION OF MAGNETITE AND CALCITE CONTENT

Prior to undertaking garnet upgrading, representative samples from the W1 and W3 lots were pulverized and chemically analyzed and the results are presented in Table 8.

As pure andradite contains 31.4 per cent Fe_2O_3 , and pure grossularite contains 24.8 per cent Al_2O_3 , the relative proportion of both garnets in the various samples could be approximately computed (Table 9). An estimate of the diopside/augite and other impurities is also given.

An attempt was made to determine more precisely the level of magnetite and calcite in both W1 and W3 lots, and therefore, a portion of each head sample was submitted to (i) a low intensity magnetic separation, and (ii) a diluted HCl leach for five minutes (*i.e.*, approximate effervescent period). Results are shown in Table 10.

The relatively small concentration of magnetite in the garnet ores renders its removal unnecessary. The calcite, albeit slightly more abundant, is expected to be largely discarded by high-intensity magnetic separation which may be used to beneficiate garnet.

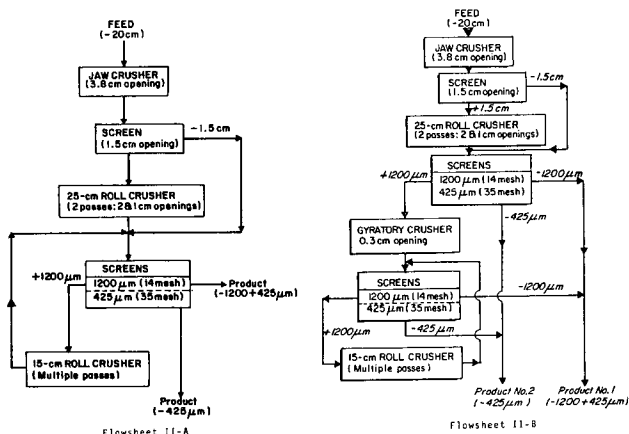

Figure 6. Wet comminution.

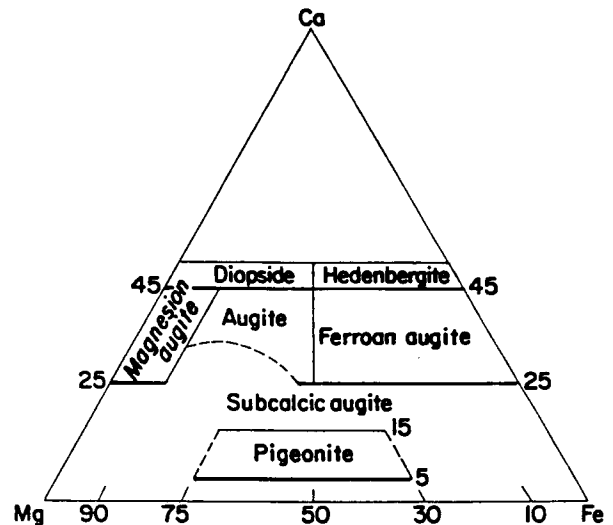

Figure 5. Subdivisions and nomenclature of the Ca-Mg-Fe-(Al) Pyroxene.

High-intensity magnetic separation was chosen to upgrade the garnet concentrate, since this method is likely to reject the nonmagnetic quartz, calcite and apatite and, to a lesser degree, the augite-diopside which has a lower magnetic susceptibility than the garnets. Two separators, namely, a Stearns cross-ring electromagnetic laboratory unit and an Eriez 10-centimetre magnetic roll were tested. The main difference between the two separators is their principle of operation. The Stearns is a lift-type unit with a static electromagnet inducing a soft iron wheel turning horizontally over a transversal conveyor belt, from which it picks the magnetic particles and carries them aside to a receptacle (Figure 9). With the Eriez separator, discs of Co-Sm permanent magnets are stacked vertically in the roll carrying the conveyor; the non-magnetic particles are thrown away by centrifugal force, while the magnetic minerals attracted by the magnets stick to the belt and report under the separator (Figure 10).

Samples of the W1 and W3 products (-1200+425 μm) from the dry comminution process (flowsheet II-B) were passed on the Stearns set at 3.0 and 1.5 amperes. Portions from the same products were also treated with the Eriez separator with the magnetic roll turning at 265

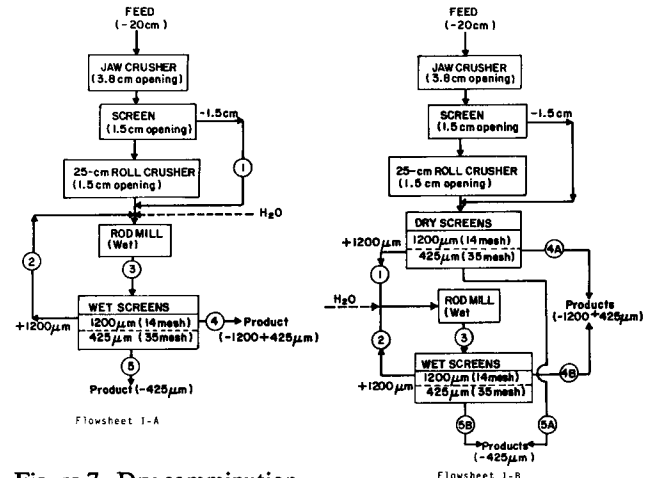

Figure 7. Dry comminution.

TABLE 6
GARNET GRAIN SIZE ANALYSIS

Size range		-1200 + 850 μm	-850 + 600 μm	-600 + 425 μm	-425 + 150 μm	-150 μm
Wt%	W1	44.7	16.5	11.6	18.1	13.3
Dist'n	W3	nil	3.9	25.3	31.3	39.5

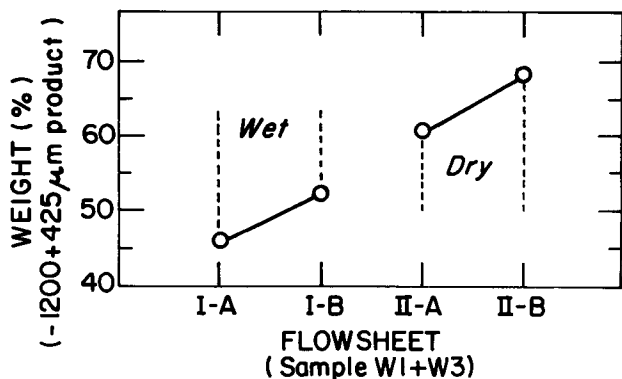

Figure 8. Effect of comminution and classification procedure on the weight percent of products.

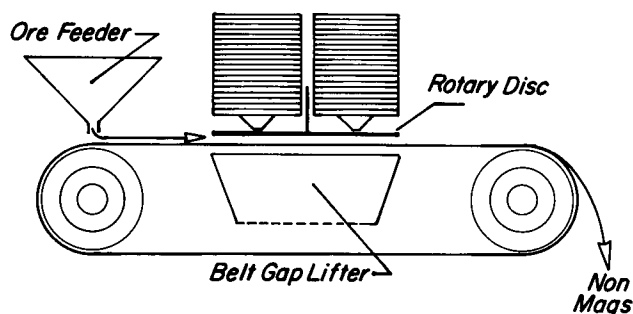

Figure 9. Stearns lift-type disc separator.

rpm for the W1 sample and at 205 rpm for the W3 sample. A decrease of angular velocity was necessary for W3 because of a lower magnetic susceptibility of the grossularite (*i.e.*, a garnet with less iron oxide). Tests were also conducted on subfractions from W1 and W3 products, namely, -1200 + 850, -850 + 600 and -600 + 425 μm , using the Co-Sm roll set at various angular velocities. The weights of the magnetic and non-magnetic products are reported in Table 11 with the corresponding operating conditions.

The nonmagnetic products from the Stearns separator consisted essentially of quartz, calcite and apatite. In addition to these gangue minerals, the rejects of the Eriez separator contained augite-diopside and some unliberated andradite and grossularite. This is indicated by chemical analyses made on the products and reported in Table 12. The selectivity of the separations are illustrated in Figure 11.

Note: To reduce the analytical load, only the magnetic and nonmagnetic fractions from one size range were analyzed and the results applied to the whole sample in the following tests: W1 at 250 and 290 rpm and W3 at 190 and 250 rpm. This assumption is acceptable since the weight distribution of the products does not vary significantly with size for any rpm tested.

CONCENTRATES

Large amounts of garnet concentrates were produced from the four samples submitted by POLESTAR, namely, W1 and W2 (the two andradite-rich zones) and W3 and S (the high grossularite occurrences). The dry comminution flowsheet II-B process was used in all cases followed by magnetic separation on the Co-Sm roll set at 265 rpm for W1, 285 rpm for W2, and 205 rpm for W3 and S. The magnetic concentrates were scrubbed for 3 minutes, washed, dried and shipped to a laboratory specializing in jet and blasting technology for evaluation. The results of the beneficiation are summarized in Table 13.

POLESTAR also requested large quantities of sized, cleaned garnet, namely, -1200 + 850 - 850 + 600 and - 600 μm , from a blend of W1, W2 and W3 zones. To achieve this, the W samples were mixed in equal

TABLE 7
RESULTS OF COMMINUTION

Flowsheet:	-1200 + 425 μm			-425 μm		
	W1	W2	W1+W2	W1	W2	W1+W2
1-A	-	-	46.7	-	-	53.3
1-B	-	-	52.5	-	-	47.5
II-A	60.2	61.0	60.6	39.8	39.03	39.4
II-B	68.0	66.6	67.4	32.0	33.4	32.6

TABLE 8
HEAD ANALYSES OF GARNET SAMPLES

Sample	% Fe ₂ O ₃	% Al ₂ O ₃	% MgO	% Mn	% S
W1	25.2	1.28	1.82	0.21	0.04
W3	13.7	9.18	2.27	0.28	0.02

amounts, crushed and screened along the wet flowsheet and the product (1200 x 425 μ m) and passed on the Co-Sm roll set at 260 rpm. The magnetics were then sieved into the three desired fractions with each of these being weighed and analyzed (Table 14).

CONCLUSIONS AND RECOMMENDATIONS

The study was aimed at identifying processes to reduce a garnet-bearing ore to minus 1200 micrometres, to screen out a fraction (-1200 +425 μ m) suitable for sandblasting testwork and to purify it from its main contaminants, namely, diopside/augite, quartz, calcite and apatite.

The desired fineness was obtained by a combination of crushing (jaw and roll) down to 1.5 centimetres, plus either wet rod milling or further dry crushing using a gyratory crusher followed by a small double roll unit. The latter approach gave the highest weight per cent of prod-

of the garnet end products. For instance, W1 and W2 have a much higher ratio of andradite to grossularite than W3 and S. This necessitated a different angular velocity on the Co-Sm magnetic roll and resulted in significant variance in the specific gravity and chemical analyses of their respective concentrates as indicated in Table 15.

The composition of the products, their specific gravity and XRD analyses all indicated a garnet (andradite plus grossularite) concentration of 95 per cent or better, with little augite-diopside and a trace of quartz as the only significant contaminants. Conversely, the nonmagnetic rejects contained up to 30 per cent augite-diopside, 15 per cent quartz and small quantities of tremolite, calcite, apatite and pyrite. Blended -1200 +425 μ m fractions from W1, W2 and W3 were also upgraded to 25.6 per cent Fe₂O₃ and 3.48 per cent Al₂O₃ (with only 1.00% MgO) using the Co-Sm separator set at the intermediate angular velocity of 260 rpm. Assuming that all the iron and aluminum oxides are in the form of andradite and grossularite, the total garnet content of this magnetic

TABLE 9
APPROXIMATE MINERAL COMPOSITION OF GARNET ORES

Sample	Andradite	Grossularite	Diopside/Augite	Others*
W1	80-85 %	5 %	5-10 %	5 %
W3	40-45 %	35-40 %	5-10 %	5 %

*Including mainly quartz, apatite, calcite and magnetite

ucts (63.3 to 68.0%), but required multiple passes on the small roll crusher at increasingly narrower adjustments. This shortcoming might be corrected in plant operation by using the novel high pressure grinding rolls marketed by KHD Humboldt Wedag and Krupp Polysius. The roller presses have a higher ratio of size reduction than the conventional grinding rolls and, when compared to other comminution technology (e.g., rod or ball mill) for the tertiary grinding, they are cheaper both in capital and operating costs (Dolezil and Reznicek, 1990). The Barmac Retopactor has recently also been recommended to separate garnets from ore (Parekh *et al.*, 1990). Because of differences in the mineralogy of the ore samples, their separate beneficiation might be advantageous for optimizing the processing conditions (particularly magnetic separation) and for specific composition

concentrate is calculated at 96.8 per cent. For higher capacity, efficiency and lower operation costs in plant operation, the use of the novel large diameter magnetic drum, equipped with super-strength neodymium-boron-iron permanent magnets, is recommended for garnet upgrading and should be tested in this respect.

ACKNOWLEDGMENTS

Mineralogy work was performed by J.M.D. Wilson, Core Technologies & Services laboratory, CANMET, Energy, Mines and Resources Canada, Ottawa, Ontario, K1A 0G1.

TABLE 10
CONTENT OF MAGNETITE AND CALCITE IN W1 AND W3 SAMPLES

Technique	Products	Weight %	
		W1	W3
I - Hand magnet	Magnetite	0.25	0.025
II - HCl (4%) leach	Soluble matter*	0.88	1.30

*Mainly calcite, but other species might also be solubilized.

TABLE 11
CONDITIONS AND RESULTS OF MAGNETIC SEPARATION

Sample W1			Separator (Conditions)		Sample W3		
Magnetic Product Weight %					Magnetic Product Weight %		
98.7 97.1			Stearns (3 amp.) Stearns (1.5 amp.)		98.3 96.5		
-1200 +850 μm	-850 +600 μm	-600 +425 μm	Eriez Co-Sm Roll		-1200 +850 μm	-850 +600 μm	-600 +425 μm
			rpm	rpm			
94.8	94.3	94.8	250	190	88.2	94.3	91.8
92.6	92.7	92.2	265	210	85.3	88.3	87.7
86.4	87.5	84.2	290	230	82.9	85.4	81.0
				250	79.2	80.3	80.5
90.1			265	205	89.2		

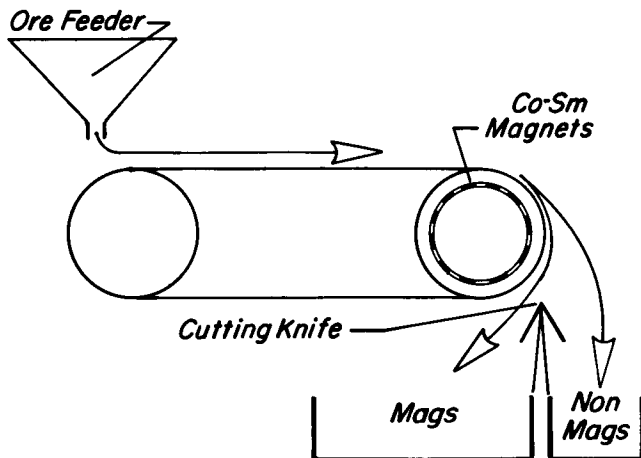

Figure 10. Eriez Co-Sm roll separator.

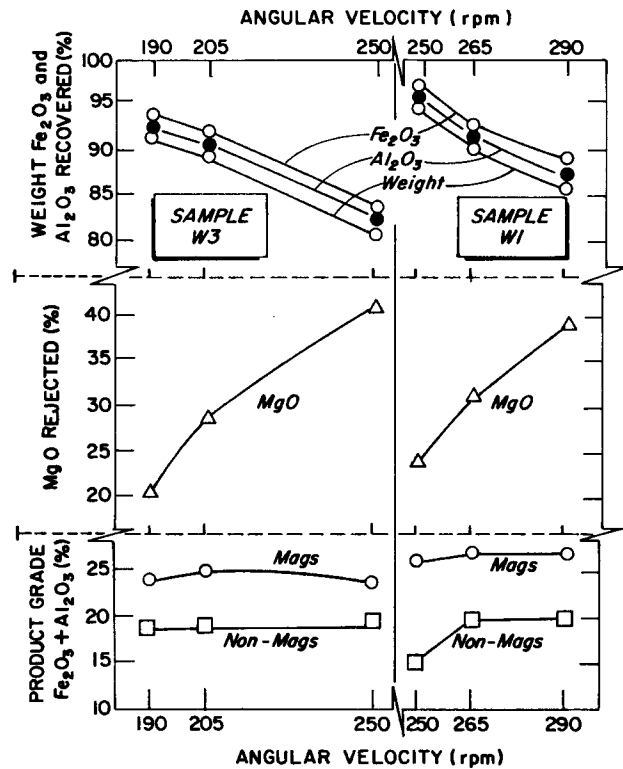

Figure 11. Effect of angular velocity on grade of products and selectivity of separation.

TABLE 12
ANALYSES AND DISTRIBUTION OF IRON, ALUMINUM AND MAGNESIUM OXIDES IN THE MAGNETIC SEPARATION PRODUCTS

Sample	Magnetic Roll rpm	Products	Weight %	Analysis, %			Distribution, %		
				Fe ₂ O ₃	Al ₂ O ₃	MgO	Fe ₂ O ₃	Al ₂ O ₃	MgO
W1	250	Mags	94.6	25.0	1.44	1.62	96.9	96.2	76.2
		Non-mags	5.4	14.0	1.00	8.86	3.1	3.8	23.8
		Feed (c)	100.0	24.4	1.42	2.01	100.0	100.0	100.0
	265	Mags	90.1	25.7	1.59	1.47	92.4	91.6	70.2
		Non-mags	9.9	19.2	1.32	5.67	7.6	8.4	28.9
	290	Feed (c)	100.0	25.0	1.56	1.88	100.0	100.0	100.0
Mags		86.0	25.7	1.47	1.44	89.3	87.1	61.6	
W3	190	Non-mags	14.0	18.9	1.34	5.50	10.7	12.9	38.4
		Feed (c)	100.0	24.7	1.45	2.01	100.0	100.0	100.0
		Mags	91.4	14.7	9.68	2.06	93.8	92.6	79.5
	205	Non-mags	8.6	10.4	8.28	5.64	6.2	7.4	20.5
		Feed (c)	100.0	14.3	9.56	2.37	100.0	100.0	100.0
	250	Mags	89.2	14.8	9.88	1.92	92.2	90.6	71.6
Non-mags		10.8	10.3	8.45	6.28	7.8	9.4	28.4	
Feed (c)		100.0	14.3	9.73	2.39	100.0	100.0	100.0	
250	Mags	80.8	14.3	8.88	1.72	83.8	83.1	59.1	
	Non-mags	19.2	11.6	7.62	5.01	16.2	16.9	40.9	
		Feed (c)	100.0	13.8	8.64	2.35	100.0	100.0	100.0

Note: To reduce the analytical load, only the mags and non-mags from one size range were analyzed and the results applied to the whole sample in the following tests: W1 at 250 and 290 rpm and W3 at 190 and 250 rpm. This assumption is acceptable since the weight distribution of the products does not vary significantly with size for any rpm tested.

TABLE 15
SPECIFIC GRAVITY AND COMPOSITION OF GARNET ORES

Specific Gravity	Fe ₂ O ₃ (%)	Al ₂ O ₃ (%)	MgO (%)
W1: 3.73	24.9	1.39	1.36
W2: 3.71	26.0	1.80	0.46
W3: 3.60	15.7	9.99	1.92
S: 3.57	15.0	9.10	1.29

TABLE 13
SUMMARY OF CRUSHING, SCREENING, MAGNETIC SEPARATION AND DESLIMING

Sample	Crushing and Screening		Magnetic Separation (-1200 + 425 μm) and Desliming								
	Screened Products μm	Weight %	Products	Weight %	Analysis, %			Distribution, %			Specific Gravity
					Fe ₂ O ₃	Al ₂ O ₃	MgO	Fe ₂ O ₃	Al ₂ O ₃	MgO	
W1	-1200	68.0	Magnetics	60.6	24.9	1.39	1.36	92.2	90.3	64.8	3.72
	+425	32.0	Non-mags* and Slimes	7.4	17.3	1.22	6.05	7.8	9.7	35.2	3.52
	Total	100.0	Feed (c)	68.0	24.1	1.37	1.87	100.0	100.0	100.0	3.70
W2	-1200	63.3	Magnetics	57.2	26.0	1.80	0.46	91.6	89.0	87.3	3.73
	+425	36.7	Non-mags* and Slimes	6.1	22.3	2.10	0.63	8.4	11.0	12.7	3.51
	Total	100.0	Feed (c)	63.3	25.6	1.83	0.48	100.0	100.0	100.0	3.71
W3	-1200	66.6	Magnetics	58.7	15.7	9.99	1.92	92.1	90.1	67.4	3.60
	+425	33.3	Non-mags* and Slimes	7.9	10.0	8.13	6.92	7.9	9.9	32.6	3.45
	Total	100.0	Feed (c)	66.6	15.0	9.77	2.51	100.0	100.0	100.0	3.58
S	-1200	67.0	Magnetics	58.0	15.0	9.10	1.29	89.6	85.5	75.8	3.57
	+425	33.0	Non-mags* and Slimes	9.0	11.2	10.00	2.65	10.4	14.5	24.2	3.37
	Total	100.0	Feed (c)	67.0	14.5	9.22	1.47	100.0	100.0	100.0	3.54

*The "slimes" were always less than 1% by weight.

TABLE 14
MATERIAL BALANCE OF GARNET BENEFICIATION OF THE W SAMPLES

Products	Weight %	Analysis, %			Distribution, %		
		Fe ₂ O ₃	Al ₂ O ₃	MgO	Fe ₂ O ₃	Al ₂ O ₃	MgO
Magnetics:							
-1200 +850 μm	36.9	26.0	3.29	1.03	39.4	32.5	26.8
-850 +600 μm	28.9	25.2	3.48	1.09	29.9	26.9	22.1
-600 425 μm	24.2	25.3	3.78	0.99	25.2	24.5	16.9
Total Magnetics	90.0	25.6	3.48	1.04	94.5	83.9	65.8
Non-magnetics	10.0	13.4	6.04	4.86	5.5	16.2	34.2
Feed (calcd)	100.0	24.3	3.74	1.42	100.0	100.0	100.0

Note: Assuming that all the iron and aluminum in the magnetic products are in the form of andradite and grossularite, their garnet content would be 97.3, 95.5, 97.5 and 96.8, respectively.

REFERENCES

- Dolezil, M. and Reznicek, J. (1990): Mineral Processing 1989 - Trends and Development; *International Mining*.
- Grond, H.C. and Wolfe, R. (1990): Geological and Diamond Drilling Report on the Crystal Peak Garnet Property, Osoyoos Mining Division, Southern, B.C., unpublished report for Polestar Resources Ltd.
- Keep, M. (1990): Garnet Electron Microprobe Analyses from the Mt. Riordan Property, Apex Alpine, British Columbia; Appendix I in Crystal Peak Garnet Corporation Information Package.
- Parekh, B.K. et al. (1990): Industry Newwatch - Concentration; *Mining Engineering*; Volume 42, Number 6, pages 542 to 543.
- Ray, G.E. and Dawson, G.L. (1988): Geology and Mineral Occurrences in the Hedley Gold Camp; *B.C. Ministry of Energy, Mines and Petroleum Resources*, Open File Map 1988-6.
- Ray, G.E., Dawson, G.L. and Simpson, R. (1988): Geology, Geochemistry and Metallogenic Zoning in the Hedley Gold-skarn Camp; *B.C. Ministry of Energy, Mines and Petroleum Resources*, Fieldwork Paper 1988-1, pages 59 to 80.

DIAMONDS IN SASKATCHEWAN

By Malcolm Richard Gent

Saskatchewan Geological Survey, Saskatchewan Energy and Mines, Regina, Saskatchewan

ABSTRACT

The diamond industry has an attractive long term past and projected market stability. The exploration and mining costs for diamonds tend to be low. The industry has a high success factor in comparison to other mineral exploration.

The presence in Saskatchewan of eight kimberlite pipes of probable late Albian age has been reported. An abundance of aeromagnetic anomalies possibly attributable to kimberlite pipes have been identified and it is anticipated that industry has acquired reasonable proof of the presence of twenty to forty or more kimberlite pipes in Saskatchewan. Historical reports of diamonds, the discovery of kimberlite pipes and these aeromagnetic anomalies indicate the Phanerozoic Basin and some parts of the exposed Shield in Saskatchewan have an excellent potential for the occurrence of economically exploitable diamond deposits. The presence of some igneous minerals found in some salt solution breccias also indicates the probable occurrence of extensive diatreme activity during the Devonian.

A Laramide Orogeny-induced crustal hinging or arching of the eastern margin of the Phanerozoic Basin and probably dextral wrenching-induced arching and faulting within the basin are proposed as major factors in the emplacement of Cretaceous or younger kimberlites. Zones of crustal weakness between sub-cratonic Archean blocks and internal faults are also thought to be significant controlling factors in the location of kimberlites in Saskatchewan.

Mapped aeromagnetic anomalies interpreted as being possibly due to kimberlite pipes generally tend to be concentrated in areas underlain by a basement of or with components of Archean age. Within Saskatchewan, these anomalies occur within the probable Trans-Hudson Orogen zone; the Rae-Hearn Craton margin; and the northeast flank of the Elkpoin Basin. Recognized areas of potential for kimberlite emplacement are the Phanerozoic basin margin, the western limit of the Superior Province adjoining the Churchill Province, and a swath approximately 150 kilometres wide along the NE-SW trending Shaunavon linear and other areas of inner basin arching.

INTRODUCTION

Until the discovery of kimberlite in 1988 near Prince Albert, there was very limited documentation of any intrusive or orogenic activities involving the Phanerozoic sediments of Saskatchewan. Most if not all anomalous structures within the basin were thought to be due to the dissolution of evaporite sediments, which have underlain most of the basin. The announced presence of diamondiferous kimberlites in Saskatchewan has generated a considerable amount of interest in the region and may be of major significance in the local economic development. The local geology fits reported optimum conditions for

the occurrence of economical diamondiferous kimberlites. The limited press releases by major exploration companies to date are also considered encouraging.

The local diamond exploration play is still very new and it is expected that significant developments will be reported in the next few years. Large areas remain to be explored and many of the previously reported anomalous structures in the basin reinvestigated.

THE ECONOMICS OF DIAMOND EXPLORATION AND MINING

The economic aspects of the diamond exploration and mining industry are the least known aspects of the diamond industry. Readers interested in specific aspects of this matter are referred to papers such as those of C.J. Johnson et al (1989), C.M.H. Jennings (1990), J.F. Smoak (1985), and J.W. Pressler (1985). In general the overall local infrastructure, capital costs and high ratio of success they apply to diamond exploration and mining in Saskatchewan appears to be very encouraging.

The variations in prices, supply and demand of diamonds in comparison to many other natural resource commodities have been remarkably reliable due to the ability of the CSO (De Beer's Central Selling Organization) to stabilize the market conditions. The world production of diamonds in 1984 was reported to rank fifth in world mineral production. Diamond production has grown from 15.5 million carats in 1950 to 98.7 million in 1988 - a 14 per cent average growth per annum. Despite declining industrial grade prices, overall prices are also forecasted to rise 1.6 to 2.5 per cent per annum (C.J. Johnson *et al.*, 1989).

Production of synthetic diamonds represents almost three quarters (75%) of the total world production. All economic synthetic diamond production is limited to industrial grades which are worth \$1.00 to \$3.00 per carat. Natural diamonds are mined from kimberlite and lamproite pipes and some associated alluvial gravels. The very high world average (1 in 40) of kimberlite and lamproite pipes being economical is due in part to the high value of natural gem quality diamonds (on average approximately \$100/carat). There are approximately 2 000 known kimberlite bodies in the world of which approximately 50 are economic. Other types of rock bodies are far less likely to contain a given ore body.

Kimberlite and lamproite pipes present relatively small exploration targets (Figure 1). The size distribution of these pipes by order of magnitude (Figure 2) suggests that 11 hectares is the usual minimum size of economically exploitable bodies. Exceptions to this do exist for some kimberlite dikes with very high grades.

HISTORY OF DIAMOND EXPLORATION IN SASKATCHEWAN

Interest in diamond exploration in Saskatchewan has been episodic, shrouded in mystery, and until very re-

cently, never substantiated by physical evidence. Documentation of past diamond exploration at Saskatchewan Energy and Mines is limited, but there are three known periods.

The first records at Saskatchewan Energy and Mines are from March 30th, 1948 when articles in the Montreal Daily Star and a Seattle newspaper reported that a prospector from Flin Flon, had found five diamonds in the province. It is thought that the reported discovery was in the vicinity of the Choiceland area where seven kimberlite pipes have been found recently.

The first major diamond staking rush occurred when thirty claims were filed in June of 1961. By September of that year about five hundred claims were filed with the mining claims recorder in Prince Albert. Two diamonds of approximately one-quarter inch (0.64 cm) diameter were claimed to have been found in the Nesbit Forest Reserve, six kilometres west of Prince Albert. This is close to Monopros Ltd.'s discovery area of kimberlite.

The present level of diamond exploration activities within the province is due to the discovery of a diamondiferous kimberlite body on the north shore of Sturgeon Lake, approximately thirty kilometres northwest of Prince Albert. The announcement of this discovery was made in November of 1988. By the end of 1988, a total of 133 826 hectares of land had been claimed. This increased to 443 390 hectares by the end of 1989 and to an estimated 742 277 hectares by December 31st 1990. Most of these claims are in the Prince Albert area. Interest in diamond exploration and staking in the Phanerozoic basin has spread to most parts of the province (Figure 3) including: the Last Mountain Lake, Lake Diefenbaker, Val Marie, Cypress, Yorkton, Tobin Lake, Wapawekka Lake, Dore Lake and other areas. In addition, investigations have been extended to include parts of the exposed Precambrian shield.

GEOLOGIC SETTING

Most exploration for kimberlites in Saskatchewan is within the Phanerozoic basin. This area extends westward from the Manitoba border to the Alberta border and from the U.S. border to the southern margin of the exposed Canadian Shield. This represents a surface area of over 6 000 000 hectares.

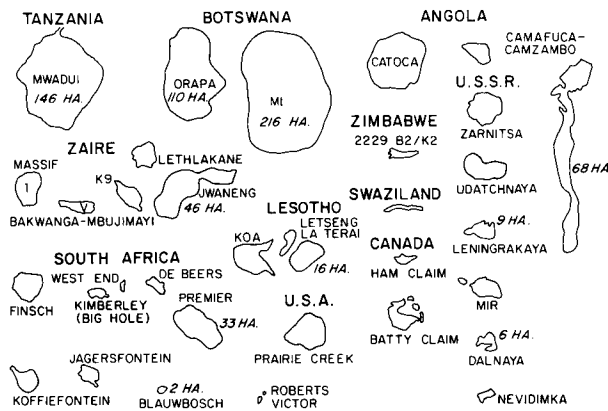

Figure 1. Examples of the variations in size and shape of kimberlite pipes.

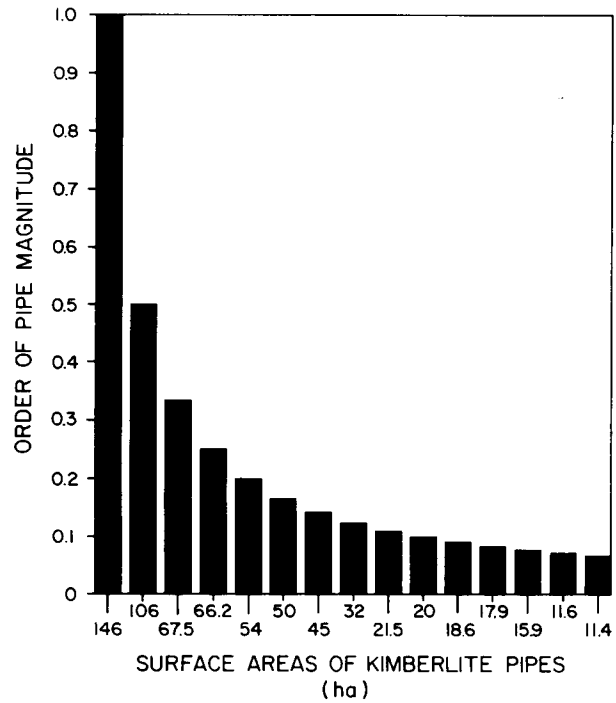

Figure 2. Histogram of the distribution in size of economic kimberlite pipes.

The region consists predominantly of grasslands grading northwards into dense coniferous and mixed forests. It is underlain by Phanerozoic sediments lying on a mostly Archean basement. The nearly horizontal bedrock strata are overlain by glacial drift that varies substantially in thickness from zero to up to 300 metres but in most areas averages from 60 to 100 metres. Generally, the major physiographic features are controlled by the bedrock structure and preglacial erosion. The poorly consolidated Mesozoic and Cenozoic sediments that underlie most of the area were easily disturbed by glaciation, making local distinction between bedrock and till difficult in some areas. Repeated glaciation and ice-generated bedrock structures, further increases the complexity of the overburden materials of Saskatchewan.

Major topographic features in southern Saskatchewan include: the Missouri Coteau; Cypress and Pasquia Hills; and the Duck, Moose, Spirit and Wood Mountains. All of these features are characterized by bedrock exposures that represent preglacial topographically high features. In contrast depressions in the preglacial topography have subsequently been partially filled. Most of the bedrock of the study area consists of Mesozoic clastics overlying the Paleozoic carbonates. In the extreme south, this sequence is capped by Tertiary clastic sediments. In the northeastern corner of the basin of Saskatchewan, the sediments have been eroded down to the Paleozoic carbonates. The publicized kimberlite discoveries in Saskatchewan appear to have intruded lower Cretaceous sediments and are expected to be of late Albian, or younger age. For a description of the Phanerozoic stratigraphy of Saskatchewan, the reader is referred to the excellent review in Christopher, Kent and Simpson (1971).

Some aspects of the cause for the origin and the emplacement of kimberlites are still debated and the

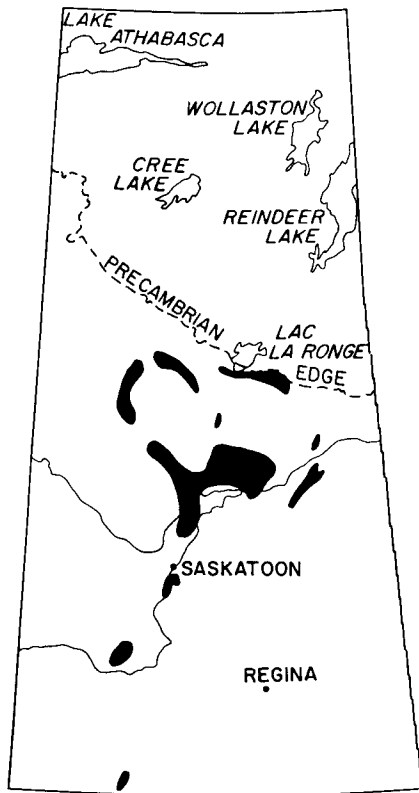

Figure 3. Map of Saskatchewan showing generalized areas thought to have been staked for diamonds.

development of a detailed exploration model remains difficult to develop. However, all known economic diamond deposits in kimberlite are reported to occur in areas underlain by stable cratons with portions older than 2.4 billion years fused to younger belts of metamorphic rocks older than 1 billion years. Kimberlites of economic grade are typically emplaced in such areas covered by Phanerozoic sediments. In Saskatchewan only about 183 widely scattered petroleum wells have intersected the basement. Geochronologic analyses of many of these basement samples (Collerson *et al.*, 1989) indicate the basement is of favorable age for economic deposits of diamondiferous kimberlites.

Other favorable geologic features that are frequently present in areas of kimberlitic intrusions include:

1. Crustal folding or arching and faulting;
2. Major faults that could have significant transform movement and which may be major zones of crustal weakness;
3. Contacts between basement domains or subcratonic blocks that may be potential zones of crustal weakness;
4. Significant or greater than usual crustal thickness.

All of these occur within the Phanerozoic Basin in Saskatchewan.

SUB-PHANEROZOIC BASEMENT STRUCTURES

Visual interpretation of available gravity and aeromagnetic data indicates the presence of several different subcratonic blocks (Figure 4). These structures are

characterized by regional geophysical differences between subcraton blocks resulting from variations in their densities or magnetic susceptibilities or by breaks in regional geophysical trends. Of particular note is the change in basement trends defined by the regional gravity map on either side of a basement block centered under Prince Albert and Saskatoon. The eastern margin of this basement block is coincidental with the occurrence of the Fort a la Corne kimberlites.

The regional gravity data of Saskatchewan from the Geological Survey of Canada is moderately skewed by topographic effects due to excessive elevation correction values. However, this data does appear to indicate greater crustal thickness to the west of the Superior province and particularly west of the North American Central Plains Conductivity (NACP) anomaly. Areas of possible exceptions to the greater regional crustal thickness west of the NACP include the: North Battleford-Unity; Swift Current and; Beauval-Meadow Lake areas. Another, but very narrow belt of probable crustal thickening trends south-southwest from Cumberland House to between Wynyard and Yorkton where it deviates south-southeast to Moosomin.

REGIONAL PHANEROZOIC STRUCTURES

The Saskatchewan Geological Survey has been accumulating a substantial amount of geological and geophysical data based upon submissions by the petroleum exploration industry during the past fifty years. Of this

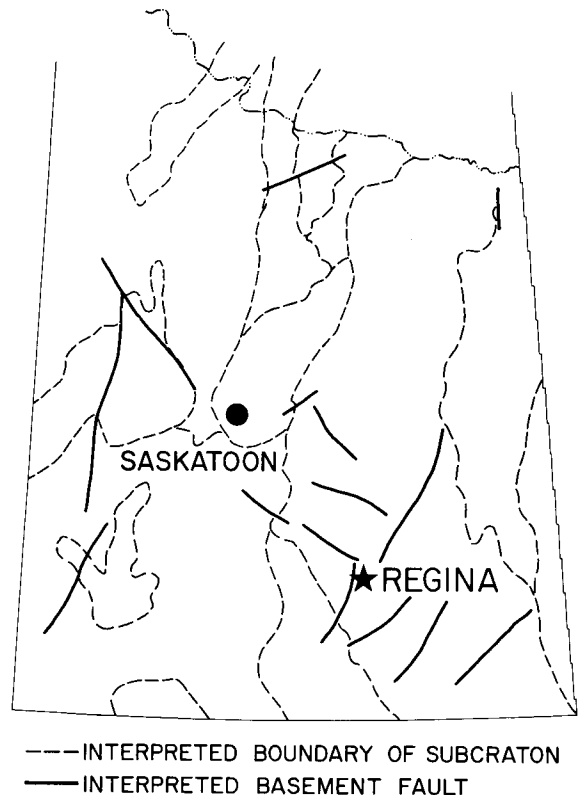

Figure 4. Structures within the sub-Phanerozoic basement of Saskatchewan interpreted from gravity survey data.

data, the gravity survey records, seismic subsurface formation isostatic maps and geologic records for virtually every drill hole penetrating the Phanerozoic sediments in the province are probably the most significant in structural and stratigraphic interpretations.

Of the known major regional structures (Figure 5), all but the Meadow Lake Escarpment are believed to be associated with basement tectonics. The Meadow Lake Escarpment appears to be an erosional feature with no apparent basement origin (Haidl, 1989).

Kimberlite emplacements are frequently associated with antecisinal (arching) structures. The age and trend of such events are important to the development of a kimberlite exploration model. Two diatreme events, one Albian or of younger age and the other of Devonian age have been identified. There are also indications of probably Late Campanian or younger intrusive event in south-western Saskatchewan.

Of the major regional structures, the northeast-trending Shaunavon linear is difficult to map accurately. First defined by Christopher (1980) as the Shaunavon Syncline, based on the presence of highly fractured calcilutites in the Jurassic Shaunavon Formation and a depression in the pre-Dina and Pre-Pense (Lower Cretaceous) erosional surface. This linear occurs east of the preglacial Tyner Valley and the paleo-trough in the Upper Cretaceous Second White Speckled Shale in the Prince Albert area. It also aligns with the present drainage divide between the South Saskatchewan River system and the Old Wives Lake - Qu'appelle River system (Christopher, pers. comm., 1990). The vertical changes in paleotopography would suggest that appreciable tectonic arching and down warping has occurred along this trend but the lineament is obscured to some extent by other large paleo-sedimentary trends.

As yet little has been published of the generally east to west trending Punnichy Arch and west-northwest to east-southwest trending Molanosa Arch. Although well hole data of this structure is very limited, there is evidence to indicate that the Molanosa Arch was active

subsequent to the deposition of the Winnipegosis Formation, especially so during the Devonian and Jurassic but also to a lesser extent in more recent times. The Punnichy Arch has not been as well defined by drill hole data as one might desire but it is known to have been most active at the end of the deposition of the Mannville Formation (Late Albian). The present high topographic form over this structure also suggests that there has been some tectonic arching subsequent to the Albian.

The Val Marie Arch (Bowdoin Dome) was predominantly active (trending north-south) during the late Cretaceous Laramide orogeny and has associated kimberlitic intrusives. This area may also have been active as a flank to a north-south trending synclinal feature active further to the west during the Jurassic.

The Sweetgrass-North Battleford Arch is a major, complex structure with many diverse and subtle components. At different geologic times it appears to have included the Swift Current Platform, which is the most tectonically active region within the area of investigation. The Swift Current Platform (including the Cypress Hills) was particularly active during the end of the Jurassic with an estimated total vertical rise relative to Meadow Lake of approximately 1200 metres. The region subsided during the early Albian (Christopher, pers. comm., 1989), but a weak and poorly defined Cypress Hills Arch, and the more clearly defined Sweetgrass-North Battleford Arch are still evident from seismic surveys using a Devonian, marker horizon. No clear tectonic trend exists for the Swift Current platform at this time due to the numerous movements of multiple blocks in that area. The only other area of Laramide tectonics includes the Battle Creek area where high geothermal heat flow regime originated at this time (Christopher, pers. comm., 1990). In addition, the presence of a white bentonite bed containing abundant thick crystals or books of biotite and other minerals at the base of the upper Colorado Second White Speckled Shale Formation is evidence of proximal volcanic activity at the time of deposition.

INTRUSIVES IN THE PHANEROZOIC BASIN OF SASKATCHEWAN

To date twelve intrusives have been shown to exist in the Phanerozoic basin of Saskatchewan. All but one of them are diatremes. Industry has reported the occurrence of seven kimberlite pipes in the Fort a la Corne area and one is known in the exposed Shield area. The two kimberlite bodies, also found by industry on the north shore of Sturgeon Lake, are thought to be ice-thrust blocks. Three diatremes of non-kimberlitic composition and a subsurface serpentine sill possibly associated with kimberlite has also been reported.

THE STURGEON LAKE KIMBERLITES

In November, 1988, Monopros (an affiliate of De Beers) reported, through the offices of the Saskatchewan Geological Survey, the existence of a kimberlite body approximately 30 kilometres NW of Prince Albert. Based on aeromagnetic data, it is estimated that this body is 110 metres in diameter. Saskatchewan Energy and Mines staff investigated the body and believe the pipe intruded the Joli Fou Formation (upper late Albian) or later. This implies that the kimberlite may have been intruded subaqueous. De Beers has stated that the

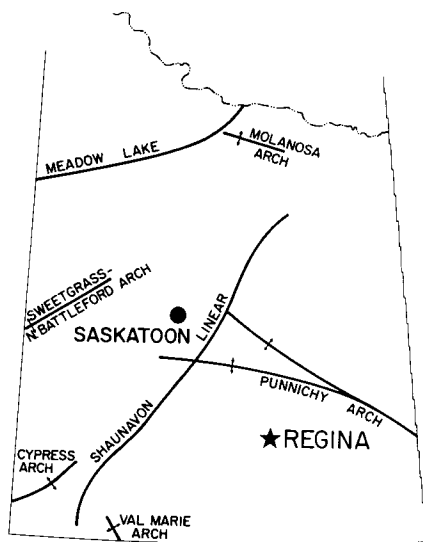

Figure 5. Regional structures of the Phanerozoic Basin, Saskatchewan.

kimberlite is diamondiferous but they consider it uneconomic.

A second kimberlite body was discovered by Corona Corporation approximately three kilometres northwest of the first. It too was reported to be considered uneconomic. It is probable that kimberlite has been intersected in other drill holes in this area.

Available Geological Survey of Canada aeromagnetic coverage does not provide any indication of a magnetic signature for either of the two reported Sturgeon Lake discoveries. The kimberlite bodies encountered in the Sturgeon Lake area have magnetic fields that decrease dramatically with height above them. It is suggested that these kimberlites are rootless, i.e. that they may be ice thrust blocks or glacial rubble. This theory for glacial transportation of kimberlite rocks to this area is also substantiated by SRC's report to the Saskatchewan Geological Survey (Simpson, Millard and Bedard, 1990). This report indicates that the overburden cover in this area is approximately 125 metres thick and that the Monopros kimberlite discovery on the north side of the southern point into Sturgeon Lake is likely to be a large ice-thrust erratic.

Fipke (1990) has reported this kimberlite to contain an unusual proportion (60-70%) of olivine. He has identified the Monopros discovery as a hypabyssal facies kimberlite with a low economic potential based on geochemical investigations of heavy minerals. Due to the lack of certainty in the evolution and emplacement of kimberlites and other diamond-bearing rocks, the validity of applying heavy mineral grain analyses for defining economic diamond potential of an intrusive rock, is at best considered questionable until a more extensively documented basis of methodology for arriving at any such conclusions becomes available.

THE FORT A LA CORNE KIMBERLITES

It has been reported that seven kimberlite pipes have been identified by drilling in the Fort a la Corne region by Uranerz Exploration and Mining Limited in joint venture with Cameco. At least one of these pipes has been confirmed to be diamondiferous, but the diamond content of the others has not been reported.

The author believes that many of the Fort a la Corne kimberlite pipes (Figure 6) have a good magnetic response and were detected by the Geological Survey of Canada aeromagnetic survey of 1967 to 1969. The size of some of the anomalies indicates that several of these pipes are large in comparison to the world average.

The economic potential of these kimberlites might well be indicated by the rarity of public releases of information made by industry during the past two years. Uranerz and Cameco have announced the recovery of six macro-diamonds (one is of gem quality and 3.85 millimetres in diameter) from less than 50 tonnes of sample material. Photographs of four of these diamonds suggests that two of them are of gem quality. It may reasonably be assumed that all four diamonds are probably from the original sample weighing less than 50 tonnes. The occurrence of these diamonds in a kimberlite pipe within the region of Trans-Hudsonian metamorphism indicates that this event was not of a high enough metamorphic grade in the lower crust or upper mantle to pass the diamond stability curve.

KIMBERLITES WITHIN THE EXPOSED SHIELD

At present there have not been any published reports of kimberlite discoveries within the exposed Precambrian Shield in Saskatchewan. It is anticipated however, that discoveries in this area will be announced shortly.

At least one diatreme of probable kimberlitic composition within the exposed Precambrian is known to this author. This diatreme is composed of an intensely brecciated and weathered intrusive rock occurring in a sub-circular form. The matrix of this rock has been weathered to a yellow clay containing angular fragments of country rock material (including quartz); fine, gold coloured phlogopite; and extensive limonite coating of mineral grains such as garnets and zircons. The non-magnetic heavy mineral concentrate obtained from this sample

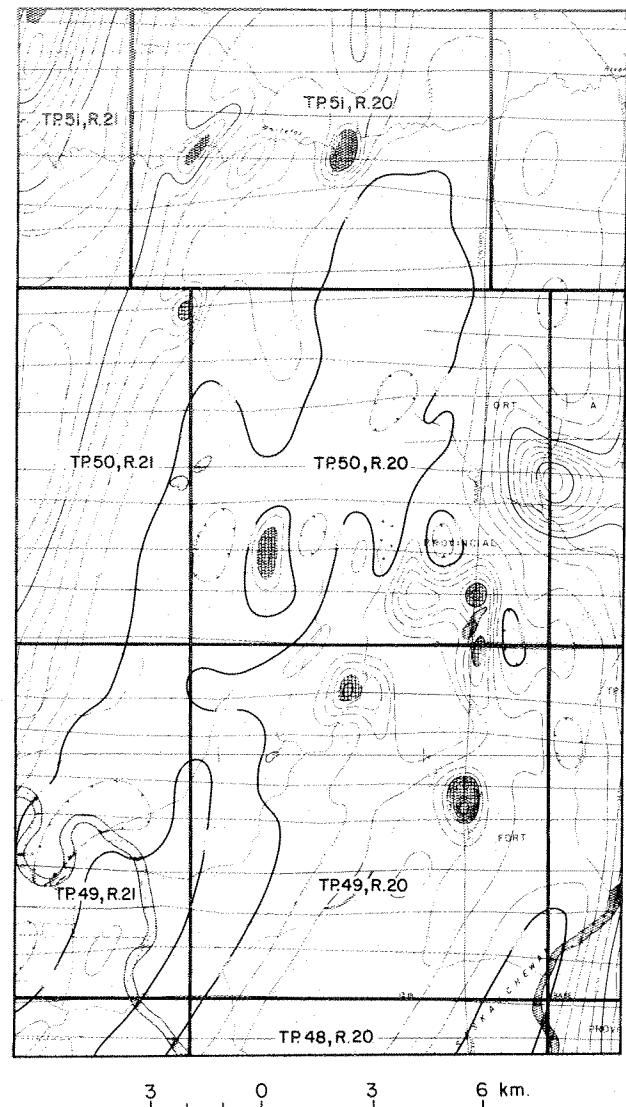

Figure 6. Some aeromagnetic anomalies in the Fort-a-la-Corne area interpreted as being due to kimberlite pipes (shaded areas) (from G.S.C. aeromagnetic survey map 7743G).

was relatively small but several G5 and one G9 pyrope garnet grains were recovered. The G9 pyrope grain has a relatively significant but less than optimum sodium content.

DIATREMES

The identified diatreme structures are very similar to salt solution structures as described by Smith and Pullen (1967) where positive structural relief is attributed to localized salt solution and collapse followed by sedimentary infilling of the resulting depression. Subsequent regional salt dissolution and settling left the localized infilling as a positive feature. The combination of diatreme material and structural form suggests that positively tested diatreme structures and possibly other presumed salt solution structures in Saskatchewan were initiated by diatreme intrusion.

The Elbow structure forms a hill occurring to the south of Lake Diefenbaker. It is characterized by a 0.15 milligals gravity anomaly and a large positive relief of the strata. At the centre of the structure, the Bearpaw Formation is more than 240 metres above the local level and is exposed at surface. This structure has been ascribed to a number of geologic processes including salt solution sink holes, thrust faulting (Haite and van Hees, 1962) and cryptovolcanic activity (de Mille, 1960).

Investigation of Devonian core samples from Imperial Elbow No. 1 well (12-25-23-6-W3) identified an abundance of garnets and zircons of diatreme origin and intensely shattered quartz grains probably from the Winnipeg Formation contained in breccia formed at the end of the Upper Devonian. The interpreted diatreme origin of this structure is based primarily on: the abundance of garnet grains; their pitted or corroded form (Figure 7) and coating of kelyphite; and the presence of shock shattered quartz grains (Figure 8) probably from the Winnipeg Formation. Chemical analyses of the garnet

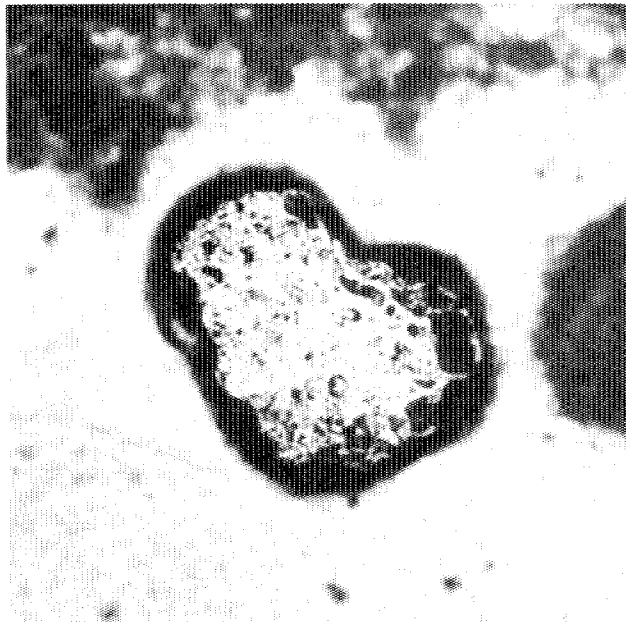

Figure 7. Corroded garnet grain within Devonian breccia of the Birdbear Fm. (Imperial Elbow No. 1 well - 797 m K.B.). Field of view - 2.2 mm.

grains indicates some are of eclogitic origin, but none appear to be of kimberlitic affinity.

Also of note is the heavy minerals identified in Imp Barnes well (1-33-61-17-W3) and Birsay Cr. #1 well (13-04-25-08-W4). These include: oval polished, violet and pink-brown garnets, books of biotite and zircons. The oval and polished form of these grains without any frosting produced by sedimentary transportation suggests they were derived locally rather than from a shield source. Electron Probe analyses of the heavy mineral fractions from breccias encountered in these wells detected G1, G4/G5 and possible G4 pyropes in addition to fayalite and chromite grains. The presence of fayalite in these samples is considered to be extremely unusual in view of the depositional environment of the breccia sediments sampled. The composition of these grains appears indicative of a source rock of basaltic affinity. It is proposed that this breccia was produced by diatreme activity, probably of upper Devonian age. These analyses are not indicative of a kimberlitic intrusive but the sample size used was extremely limited and these results may not be representative of the diatremes rock type affinity and actual composition.

THE MORSE SERPENTINE SILL

A 23 centimetre long, 10 centimetre diameter section of core from the Tide Water Signal Morse well (12-17-16-7W3) was found to consist of lizardite. This is a form of serpentine that might best be described as a chromite-phlogopite (?) orthopyroxene dunite. It does not meet the textural criteria for kimberlite but could represent a member of a sill complex that may be associated with kimberlite.

STRATIGRAPHIC AND SEDIMENTARY ANOMALIES

A number of anomalous features of possible signifi-

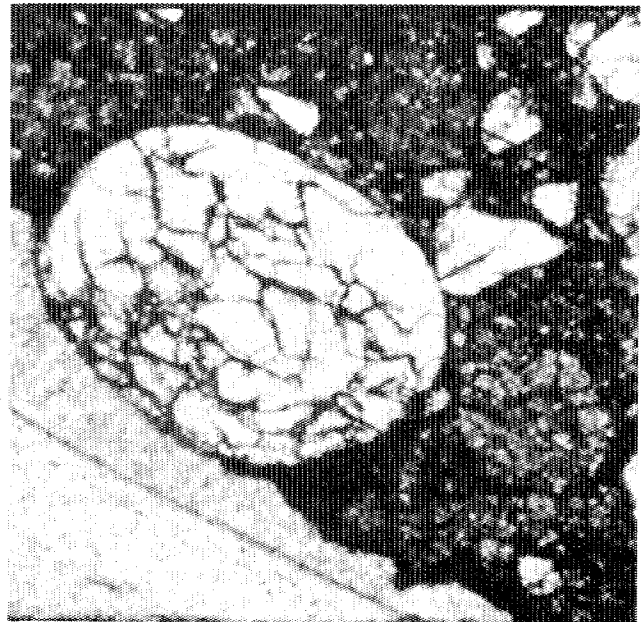

Figure 8. Shock shattered quartz grains possibly from the Winnipeg Fm. within Devonian breccia of the Birdbear Fm. (Imperial Elbow No. 1 well - 797 m K.B.). Field of view - 2.2 mm.

cance to precious gem exploration have been identified from data acquired during more than fifty years of petroleum industry and government exploration activities in the Phanerozoic basin. These features are primarily identified in drill hole results (core and geophysical logs) and are represented by breccias, local collapse or subsidence, missing formations and localized sedimentary domes not produced by pinnacle reef complexes.

Many diverse theories have been proposed for the origins of some of the features. A partial list includes:

- Astroblems (Sawatzky, H. B., 1975)
- Cryptovolcanism (de Mille, G., 1960)
- Faulting (Haite, T. B., 1959) (Haite, T. B. and van Hees H., 1962)
- Glacial Thrusting (Christiansen, E. A. and Whitaker, S. H., 1976)
- Hydrodynamic blowouts (Christiansen, E. A., Gendzwill, D. J. and Memeley, W. A., 1982)
- Salt Solution (Smith, D. G. and Pullen, J. R., 1967) (Sawatzky, H. B., Agarval, R. G. and Wilson, W., 1959)

It is probable that several of these theories or combinations of them are at least in part valid. It is now obvious that diatreme and intrusive activity should be seriously considered by the exploration industry, in determining the origin of such features.

Salt solution breccias are relatively common stratigraphic and sedimentary anomalies (Figure 9). Salt solution structures have generally been attributed to localized dissolution of the middle Devonian Prairie Evaporite Formation which eventually formed sink holes. In some cases these depressions were filled by

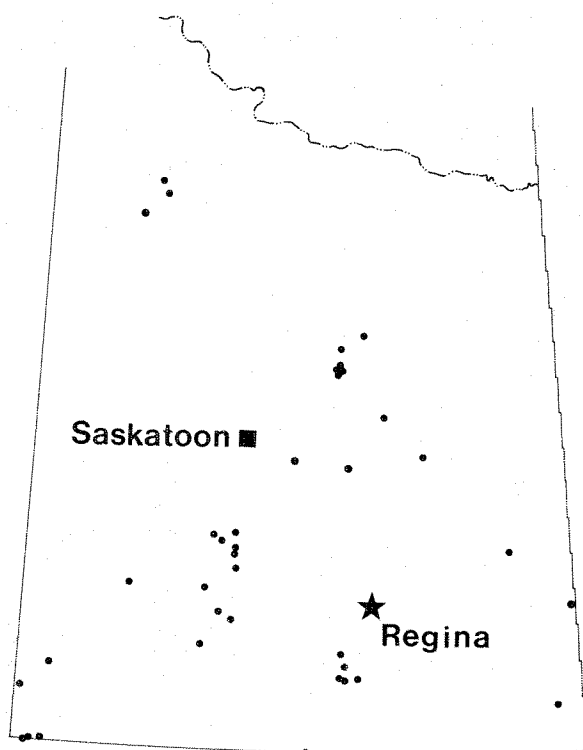

Figure 9. Location of salt solution structures identified from seismic survey and drill hole data.

sediments before more regional dissolution occurred. As a consequence, dome-like features, such as the Hummingbird structure (Smith, D. G. and Pullen, J. R., 1967) formed in the sediments above the initial localized salt solution structure.

Some of these structures are not as well documented by drilling but have been more extensively investigated by geophysical techniques. Of these, the Lanigan salt solution structure has been extensively investigated by aeromagnetic, ground magnetic, resistivity, gravity and seismic surveys. All of these surveys have found there to be a local anomaly. 3-D seismic surveying has generated a clear definition of the subsurface form of this structural and geophysical anomaly at a number of stratigraphic levels from the Cambrian Deadwood Formation to the Cretaceous Lower Colorado Formation. The continuation of the structure below the Prairie Evaporite Formation into the clastics of the Winnipegosis and Deadwood Formations supports the concept that an intrusion may have initiated this structure.

GEOPHYSICAL ANOMALIES

Anomalous structures in the Phanerozoic basin of Saskatchewan, which might be of an intrusive origin have been detected by seismic, IP, aeromagnetic and some gravity surveys. Airborne radiometrics and VLF as well as synthetic aperture radar imagery were also tested as methods for kimberlite exploration. Since kimberlites are commonly slightly enriched in uranium, radiometric surveying was done to determine if it could be used to detect the dispersion of kimberlitic material in the overburden, unfortunately the results were unsuccessful.

Magnetic surveys are proving to be, at least initially, the most effective prospecting tool available to the diamond exploration industry. Kimberlite pipes tend to have distinctive circular to subcircular magnetic anomalies (Figure 6) of very limited aerial extent which readily enable their detection by residual or derivative filtering of high resolution (0.5 nanoteslas or better precision) aeromagnetic data acquired on low altitude (approx 150 m above ground level), tightly spaced (120 to 300 m) flight lines. A possible high unserpentinized olivine content of these kimberlites might result in these intrusives having slightly higher than usual magnetic susceptibilities. This would account for some of the kimberlites discovered to date being clearly observable on regional aeromagnetic maps. It is stressed that not all kimberlite pipes have high magnetic susceptibilities and these may not have a discernable magnetic response. This variation in magnetic characteristics is due primarily to their variable ultramafic and magnetic mineral contents, degree of serpentinization and pipe geometry. Furthermore, there may be a tendency for larger pipes not to be as readily detectable with magnetic survey techniques as they may tend to be much more altered and thus have a tendency for much lower magnetic susceptibilities. The author also expects that some larger pipes may appear as negative anomalies in regions of high magnetic background values.

A tentative visual interpretation of existing aeromagnetic maps for kimberlitic pipe type anomalies combined with known kimberlite intrusions or related intrusives as well as suspected staking activities for diamonds (Figure 10) shows that there are a considerable number of potential exploration targets along two signif-

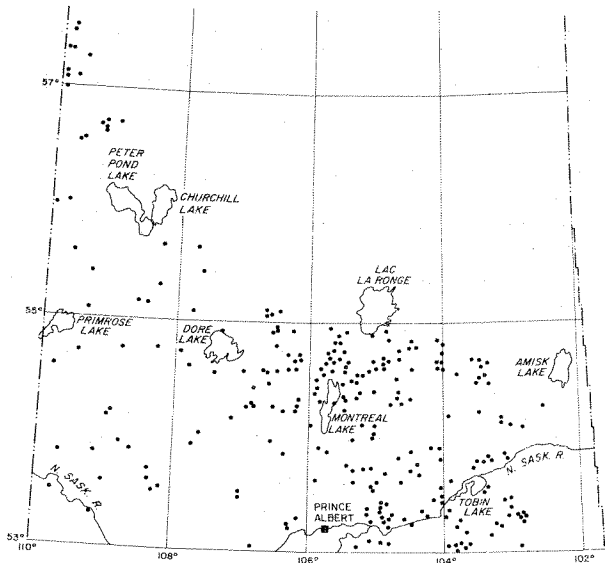

Figure 10. Aeromagnetic anomalies of possible kimberlite sources.

icant trends. The first being near the eastern margin of the Phanerozoic Basin, almost from the Arctic Circle to at least the Saskatchewan-Manitoba border and especially along the west margin of the Trans-Hudson Orogen zone incorporating the area of deformation between the Hearn and Superior cratons. The second appears to approximate the Shaunavon linear. On a very broad, regional scale there also appears to be an association between areas consisting of Archean basement rocks or having some Archean component either as a basement root or as accretion blocks and the presence of discrete aeromagnetic anomalies such as might be due to kimberlite pipes. This generalization seems to be valid for Saskatchewan, Alberta and the North West Territories (Figure 11).

GEOCHEMICAL INDICATIONS OF KIMBERLITE INTRUSIONS

Geochemical testing of overburden materials and well hole cuttings and core have been conducted with the objective of detecting indications of kimberlitic intrusions within the Phanerozoic Basin. Suitable heavy mineral indicators of kimberlites include: picro-ilmenite, chrome diopside, and certain pyrope garnets. In most cases, results based on analyses of pyrope garnet with specific gravities above 3.2 are the most commonly quoted for investigations in Saskatchewan.

For the purpose of interpreting Saskatchewan Geological Survey results, favorable analyses of garnets have been considered to consist of: Na_2O 0.08%, Cr_2O_3 2% to 8%, $\text{CaO}_2\%$, $\text{FeO}_2\%$ and MgO 10% to 25%. This range of composition would include the G9, G10 and G11 and part of G12 classes of Dawson and Stephens' classification (1975, 1976). Such a wide range of pyrope garnet compositions is considered favorable here because:

1. There is a lack of published documentation as to the composition of garnets found within non-kimberlitic igneous and metamorphic rocks vs. those occurring in kimberlites. As such, restricting

the limits of potentially favorable indicator pyropes to the G10 limits may miss significant occurrences.

2. Although excellent work has been done in the investigation of kimberlite garnet compositions, insufficient understanding of the variations in the mineralogical components of diamondiferous rocks, especially kimberlites, from different parts of the world precludes the narrow definition of pyrope garnet groups unique to such intrusives. The G9 to G12 groups of pyrope garnets appears to be part of a complete solid solution series (see Figure 12) in which variations in indicator pyrope compositions might exist due to variations in their source depths and mantle compositions.

Investigations by Saskatchewan Energy and Mines has found occurrences of kimberlite indicator minerals in the Yorkton, Elbow, Govenlock and Big Muddy Valley areas. Industry has also confirmed the occurrence of kimberlite associated minerals in the Val Marie area.

The highest concentrations of pyrope garnets in the Yorkton area were found at York Lake beach. The presence of the a picro-ilmenite grain and several indicator pyrope garnets from samples collected in this area substantiates the probability of the presence of a kimberlite pipe in the area.

Of four samples collected in the Elbow area only one sample was found to contain kimberlite indicator grains—two garnet grains with extremely high titanium and sodium content, one picro-ilmenite and one ilmenite grain both very high in titanium. The high sodium content of the garnet grains and unusually high titanium values obtained are interpreted as indicators of a probable kimberlite intrusive in this area. These results are considered especially encouraging as the amount of heavy min-

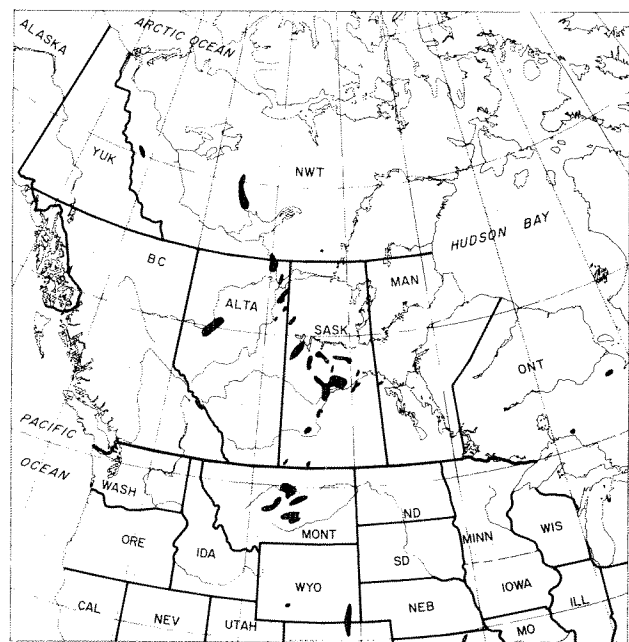

Figure 11. Distribution of kimberlite pipes and associated intrusives, claims thought to be staked for diamonds and aeromagnetic anomalies of probable kimberlite pipe origin in northwestern North America.

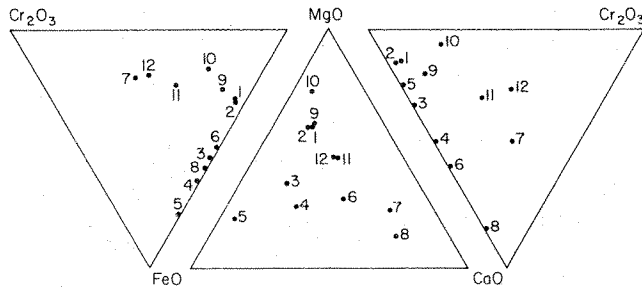

Figure 12. Variation in average chemical composition of pyrope garnet groups by Dawson and Stephen's method of classification (1975, 1976).

erals present in these samples was limited and the presence of any indicator minerals is a good indication of a kimberlitic intrusive nearby.

Near Govenlock in the extreme southwest corner of the province, a number of disturbed sediments and breccias were reported (Whitaker, 1976) to occur in the extreme southwest corner of the province. Analysis of a single sample collected in this area found that garnets were fairly abundant. Here two G5 pyropes and one favorable pyrope of the G9 to G11 range were identified.

Overburden sampling in the Big Muddy Valley area was initiated based upon apparent favorable structural geologic conditions and the generally thin overburden cover in this area. In addition, it was hoped that this study might also assist with the investigation of unsubstantiated reports that had been given to this author of macro-diamonds having been recovered in this area. Of the samples collected, only those from seven locations had garnets with significant chrome content. Of these, the Lisieux site had a disproportionately high G3 and G9 content relative to all other sites and thus is likely to be situated close to its source or to be derived from local placer concentrations in the Wood Mountain Formation that probably constitutes a significant portion of the sample material. The relatively low sodium content also suggests that these grains may be derived from a local intrusive of crustal rather than mantle origin. The most significant concentrations occur to the south of Old Wives Lake (especially the southern end), 12 kilometres southeast of Central Butte and by the town of East Poplar. Although only two pyrope garnets were identified in the sample from the Ponteix area, both have high chrome and sodium contents and may be the most encouraging kimberlite indicator garnets found in the region.

CORUNDUM OCCURRENCES

Eight corundum grains were detected during probe analysis of samples from the Big Muddy Valley area. The presence of titanium, typical of sapphires was detected in one grain. All other grains have a chromium content which produces a red (ruby) colour. Visual inspection of the probe mounts with these grains found that they appear to have a mauve-red colour typical of the highly valued Burmese rubies. Although the samples were collected on a coarse regional scale, the clustering of corundum grains in the southwest quadrant of the survey area is considered anomalous. Within Saskatchewan, sapphires or mauve to light blue corundum crystals are known to occur within the exposed shield area of Sas-

katchewan to the northeast of Wintego Lake (Kirkland, 1976) as well as north and east of Apex Lake (Forsythe, 1977). Neither of these known locations of corundum occurrences are reported to contain the ruby or red variety. Sapphires are also presently being produced south of Saskatchewan in the vicinity of Utica, Montana and are found along many parts of the Missouri River in Montana. Some red varieties do occur amongst the corundum being produced at the Yogo Sapphire Mine but these are very limited in proportion to the number of sapphires recovered.

The source of these corundum would most likely be an alkalic dike similar to the Yogo dike in Montana or a skarn alteration zone around a mafic to ultramafic intrusive within the Phanerozoics. If the source of these corundum grains contains larger crystals of gem quality, it could constitute a deposit of similar or greater value than a diamond deposit.

DISCUSSION AND CONCLUSIONS

The economics of diamond exploration and mining are attractive from a perspective of long term market stability, probability of a given pipe being economical and available low cost exploration tools and mining methods. Major difficulties lie primarily with the small target size of most kimberlite pipes but available aeromagnetic data is greatly facilitating the identification of favorable exploration targets.

There has been at least two periods of diatreme activity within Saskatchewan. The first period occurred during the Devonian and the limited results obtained to date suggest that this period of intrusive activity may have been of a crustal origin with no kimberlitic activity associated. A number of kimberlite fields were formed during the Lower Cretaceous Laramide Orogeny when conditions appear to have been optimum.

There is a general northwest (315°) trend and a tighter northeast and northwest clustering of intrusives from Lac La Ronge to Montreal Lake to Candle Lake to Fort a la Corne. The NW trend from Nipawin to La Loche appears to follow the 400 metre BSL contour of the sub-Phanerozoic basement. The southern limit of this trend approximates the monoclinial axes or basin shelf hinges interpreted here as a Laramide orogenic structure. The mapped aeromagnetic anomalies along this trend are not believed to be the result of basement magnetic anomalies being detected because this trend cuts across regional basement lithologic trends and the anomalies do not increase in density with thinning of the Phanerozoic cover. The axis of the trend also closely approximates the northeastern margin of the Devonian sediments in the Elkpoint Basin. These aeromagnetic anomalies show some correlation with the locations of major basement faults and especially sub-craton block margins.

It is thought that the emplacement of kimberlite intrusions within the study area was probably controlled by:

1. the development of monoclinial axes or basin hinges (along the eastern flank of the Rocky Mountain exogeosyncline ?) corresponding to the eastern margin of the Interior Platform as a result of the Laramide crustal compression and thickening of

the western margin of the basin as part of the Eastern Cordilleran Orogen,

2. the development of the proposed northeasterly-trending weak, broad anticlines or anteclines by probably dextral crustal wrenching and faulting to compensate for different crustal stresses along the length of the orogenic zone,

3. the intersection of northeasterly- and northwesterly-trending major weakness in the basement crust at sub-craton block margins.

The data available to date suggests that the most significant trends would include: those areas along the eastern Interior Platform margin; the Churchill-Superior Province boundary; areas of Laramide orogenic crustal arching (the Val Marie arch, the Shaunavon Linear, possibly the Sweetgrass-North Battleford arch as well as other similar small structures; and areas of significant intersections of basement sub-craton blocks and faults structures (including the Kindersley to North Battleford; Muskiki Lake; Last Mountain to Regina to Weyburn and Assiniboia; and Val Marie to Eastend areas).

Of the inner basin structures, very little is known of the occurrence of kimberlites within them. Industry has not publicized any of its results outside of the Sturgeon Lake and Choiceland areas and as such much must be left to speculation. Kimberlites are not known to this author as occurring along the Sweetgrass-North Battleford arch or any of the other anticlines/anteclines mapped with the exception of the Val Marie and those structures bordering the Shaunavon Linear. These latter areas have significant indications of alkalic and kimberlitic intrusive activity. Kimberlite intrusions are known to occur within the U.S.A. portion of the Val Marie arch and this author believes that significant investigations of several claims are underway on the Saskatchewan section. The location of proven kimberlites in the Choiceland area and the presence of: the Lanigan anomaly, the lizardite serpentine sill near Morse, the occurrences of inert gases, folding to the south of the Cypress Hills and the kimberlites in Montana appears to support the potential significance of the Shaunavon Linear and its interpreted extension northwards to the Reindeer Lake area. The presence of structures along this trend appears promising but detailed data and especially the discovery of other kimberlites along it are essential to proving its potential.

The possibility of middle to upper Devonian kimberlitic activity is demonstrated by the presence of diatreme material in the Elbow, Birsay Cr #1 and Imp Barnes structures. Limited heavy mineral chemical data for these diatremes suggests that they are not likely to have a kimberlitic affinity. Could they be associated with Devonian Elkpoint Basin margin tectonics? Spatially their occurrences might suggest so but information is far too limited at this point to derive any effective conclusions or even speculations.

The Phanerozoic Basin of Saskatchewan is a vast region suitable for precious gem exploration. Favorable indicators are wide spread and numerous. Aeromagnetic data coupled with excellent positive indicators demonstrates the potential for an economic diamond deposit. However, considerable efforts and skill will be needed to prove this potential and even more to find a

deposit. Careful evaluation of the regional tectonics, aeromagnetic and gravity data, the glacial sediments, and preglacial topography will be necessary.

ACKNOWLEDGMENTS

The assistance of all those who provided information, advice and help in completing this report are gratefully acknowledged. To list all those who have assisted would try the readers' patience but special mention is due to:

Terry Danyluk of the Potash Corporation of Saskatchewan; and the staff of Saskatchewan Energy and Mines, including Paul Guliov, J. Christopher, C. Harper, C. Gilboy, K. Kreis, B. Troyer, F. Haidl, and D. Paterson.

REFERENCES

- Christiansen, E.A., Gendzwill, D.J. and Meneley, W.A. (1982): Howe Lake: a Hydrodynamic Blowout Structure; *Canadian Journal of Earth Sciences*, Volume 19, pages 1122-1139.
- Christiansen, E.A. and Whitaker, S.H. (1976): Glacial Thrusting of Drift and Bedrock; in Legget, R.F. (ed.), *Glacial Till, Royal Society Canadian Specialists*, Publication Number 12, pages 121-130.
- Christopher, J.E., Kent, D.M. and Simpson, F. (1971): Hydrocarbon Potential of Saskatchewan; *Saskatchewan Department of Mineral Resources*, Report 157, 47 pages.
- Collerson, K.D. and Lewry, J.F. (1989): Sm-Nd Isotope Systematics of the Buried Basement in Southern Saskatchewan: Implications for Diamond Exploration; *Saskatchewan Energy and Mines*, Open File.
- Collerson, K.D., Lewry, J.F., Van Schmus, R.W. and Bickford, M.E. (1989): Sm-Nd Isotopic Constraints on the Age of the Buried Basement in Central and Southern Saskatchewan: Implications for Diamond Exploration; in *Summary of Investigations 1989, Saskatchewan Geological Survey*, Miscellaneous Report 89-4, pages 168-171.
- Dawson, J.B. (1975): Statistical Classification of Garnets from Kimberlite and Associated Xenoliths; *Journal of Geology*, Volume 83, pages 589-607.
- Dawson, J.B. (1976): Statistical Classification of Garnets from Kimberlite and Associated Xenoliths; *Journal of Geology*, Volume 84, pages 495-496.
- De Mille, G. (1960): The Elbow Structure of South-central Saskatchewan; *Journal of Alberta Society of Petroleum Geology*, Volume 8, Number 5, pages 154-162.
- Fipke, C.F. (1990): The Development of Advanced Technology to Distinguish Between Diamondiferous and Barren Diatremes; *Geological Survey of Canada*, Open File 2124, 1175 pages.
- Forsythe, L.H. (1977): The Geology of the Pylypow Lake Area (West Half), Saskatchewan; *Saskatchewan Department of Mineral Resources*, Report 173, 35 pages.
- Haidl, F.M. (1989): Distribution of Lower Paleozoic Strata in the Vicinity of the Meadow Lake Escarpment, West-central Saskatchewan; in *Summary of Investigations 1989, Saskatchewan Geological Survey*, Misc. Report 89-4, pages 125-132.
- Haites, T.B. (1959): Avonlea and its Significance; *Jour-*

- nal of Alberta Society of Petroleum Geology*, Volume 7, Number 8, pages 167-176.
- Haites, T.B. and van Hees, H. (1962): The Origin of Some Anomalies in the Plains of Western Canada; *Journal of Alberta Society of Petroleum Geology*, Volume 10, Number 9, pages 511-533.
- Jennings, C.M.H. (1990): Exploration for Diamondiferous Kimberlites and Lamproites; Modern Exploration Techniques, *Saskatchewan Geological Society of Specialists*, Publication Number 10, pages 139-148.
- Johnson, C.J., Marriott, M. and von Saldern, M. (1989): World Diamond Industry 1970-2000; Natural Resources Forum, *Natural Resources Forum*, Volume 13, Number 5, pages 90-106.
- Kirkland, S.J.T. (1976): The Geology of the Marchel - Wintego - Sandy Bay Area, Saskatchewan; *Saskatchewan Department of Mineral Resources*, Report 172, 12 pages.
- Pressler, J.W. (1985): Gem Stones; in Mineral Facts and Problems, *U.S. Bureau of Mines*, Bulletin 675, pages 305-315.
- Sawatzky, H.B. (1975): Astroblems in Williston Basin, *American Association of Petroleum Geology*, Volume 59, Number 4, pages 694-710.
- Simpson, M.A., Millard, M.J. and Bedard, D. (1990): Geological and Remote Sensing Investigations of the Prince Albert-Shellbrook Area, Saskatchewan; *Saskatchewan Geological Survey*, internal report, 30 pages.
- Smith, D.G. and Pullen, J.R. (1967): Hummingbird Structure of Southeast Saskatchewan; *Bulletin of Canadian Petroleum Geologists*, Volume 15, Number 4, pages 468-482.
- Smoak, J.F. (1985): Diamond-Industrial; in Mineral Facts and Problems, *U.S. Bureau of Mines* Bulletin 675, pages 233-247.
- Whitaker, S.H. (1976): Geology and Groundwater Resources of the Cypress Area; *Saskatchewan Research Council*, Map NTS Area 72F.

WATER FILTRATION USING PERLITE FROM THE FRENIER DEPOSIT OF BRITISH COLUMBIA

By R.D. Giles and G.W. Poling

*The University of British Columbia,
Vancouver, B.C.*

ABSTRACT

Perlite filter aid materials produced from the Frenier deposit are characterized according to size, shape, cell wall structure and specific surface area. These characteristics are correlated with precoat and body feed filter aid performance on water suspensions in a bomb-filter test apparatus. Attempts were made to assist an operating perlite producer in satisfying more sophisticated filter aid markets with finer and more closely sized filter aid materials.

INTRODUCTION

Canada's only operating perlite mine (1983 - 1986) probably owed its existence largely to a Federal government report written by H.S. Wilson (1981) of Energy Mines and Resources Canada in 1981. This report concerning "lightweight aggregates" documented several then unproven perlite deposits in British Columbia. Aurun Mines Ltd. mined approximately 3 000 tonnes per year of high quality perlite ore from one of these deposits now known as the Frenier Deposit. This mine was located approximately 60 kilometres northwest of the town of Clinton and 240 kilometres north-northeast of Vancouver, B.C. Perlite occurs at surface in two parallel zones 30 metres wide and several hundred metres long at the crest of a gently rolling hill. Elevation at the minesite is 1200 metres. Road access from Vancouver where Aurun's expansion plant was located, totalled 500 kilometres. Proven reserves of 450 000 tonnes of high grade perlite have been established.

The Frenier deposit was discovered in 1949 by Lawrence Frenier but commercial exploitation awaited Aurun's acquisition of the property in 1983. The mine was officially opened in July 1984. A pilot scale expansion plant using a 150 kilograms per hour vertical expander furnace was constructed at Aldergrove, B.C. in February, 1984. Over 3 000 tonnes of Frenier perlite ore were tested in this facility by April 1986. The plant was targetted to produce relatively coarse expanded perlite for horticultural, aggregate and insulating (cryogenic) uses to satisfy local markets. The Frenier ore proved to expand readily, produced a high yield, and a lightweight and clean finished product. Demands soon exceeded plant capacity. In the early spring of 1986 Aurun commissioned a new expansion plant in Surrey, B.C. (15 kilometres SE of Vancouver) capable of processing 4 500 tonnes per year of perlite ore.

Aurun's three initial expanded-perlite products were tailored to suit horticultural, insulation and lightweight aggregate needs. Horticultural grade perlite was coarse (up to 6 mm), had good resistance to degradation by crushing or abrasion and contained minimal fines. This product found ready users in bedding plant producers for creating easily aerated, non-compacting soils. Aurun's insulating or "cryogenic" grade perlite was usually less

dense than horticultural grades and was produced by expanding a -20 mesh (850 μm) size fraction. To be a good insulator this product had to retain as much of the expanded bubble envelope structure as possible and be thinwalled. Fines were scalped off to produce an expanded product that was generally between 16 mesh (1000 μm) and 100 mesh (150 μm). A third major product line for lightweight aggregate and plasters was of similar size to cryogenic grade. This material was tougher with thicker "walls" to withstand mixing and handling.

Production of the above three grades of perlite involved removal of significant amounts of "fines" (mostly finer than 100 mesh or 150 μm). Even very recent technical descriptions of perlite flowsheets indicate that these fines, which might comprise 25 per cent of the feed, are normally discarded (Chamberlain, 1985). Aurun soon realized that their fines might be marketable as filter aids. The Vancouver Public Aquarium uses vacuum precoat filters to provide sufficient clarity for viewing marine mammals through 11 metres of water. Aurun's expanded perlite fines (designated UF 100) proved to be an excellent filter aid for this application. Total pool volume for these mammals, including killer whales, beluga whales, seals and sea otters, is replaced every 72 hours. Filter aid consumption as precoat and bulk feed amounts to several hundred pounds each day. This filter aid application is particularly difficult since much of the purpose is to remove colloidal fecal material. Chemical coagulation and flocculation are required prior to filtration. In addition, the perlite filter aid material must be highly inert to ensure that no potential toxins are leached from it.

Precoat filter clarification of swimming pools soon found Aurun's UF 100 product an excellent filter aid. Aurun Mines Ltd. found themselves in an enviable position of having a market (for their previous discard product) exceeding production capacity.

Early-on, during the advent of Aurun into the filter aid market they contacted the Department of Mining and Mineral Process Engineering at the University of British Columbia for technical assistance in developing a wide range of filter aid products. A research proposal supported jointly by Aurun Mines Ltd. and the Vancouver Public Aquarium was then submitted by UBC to the Science Council of British Columbia. This provincial agency provided support in order "to establish process parameters and operating procedures required to manufacture consistently high quality perlite filter aid materials from the "fines" which until recently had been rejected as waste at Aurun Mines Ltd. expansion plant". Since diatomaceous earth and competing perlite products had to be imported from distances of over 1600 kilometres, the economic benefits of local production were obvious.

The major objectives of this research project were to:

- physically and chemically characterize Aurun's fine expanded perlite products,
- assist process development via close sizing of expanded products or comminution plus classification to develop more sophisticated filter aid products for the food, beverage and chemical industries,
- assist perlite filter aid applications at the Vancouver Public Aquarium.

As the research progressed more emphasis was placed on characterizing the various perlite fines supplied by Aurun and correlating their physical characteristics with measured filtration performances in a bomb-test filter.

LITERATURE ON PERLITE EXPANSION & PERLITE FILTER AIDS

A review of published literature on perlite and its use as a filter aid indicates many gaps. In particular, details on the preparative processing and expansion of perlite are sparse (Wilson, 1981; Chamberlain, 1985; Turner, 1985a,b; Barker and Hingten, 1985).

Mining methods are selected to minimize production of fines. Thus where possible in open pit mines, ripping instead of drilling and blasting is normally employed. Selective mining is employed to provide the expansion plant with feed stock having good expansion properties. Since Aurun perlite ore expands by an average of 22 times, it was obvious that an expansion plant should be located near a major market area such as Vancouver.

Figure 1 is a schematic flowsheet of the Aurun Mines Ltd. Pacific Perlite operations. In preparation for expansion, the ore was stage crushed, (often finally in a roll crusher) with closed circuit vibrating screens to yield a 100 per cent 8 mesh (2 400 μm) product. The coarsely crushed ore was next thermally dried at approximately 250°C to limit free moisture to 1 per cent (Chamberlain, 1985) during the final crushing stage. At Aurun, the dried feed was stored in hot silos and took nearly three days to cool to room temperature. After the final crushing stage the perlite was screened into at least three size fractions to satisfy needs of horticultural, aggregate and insulating applications. At the Aurun plant these three sizes were:

- 8+16 mesh (-2400 + 1000 μm)
- 16+20 mesh (-1000 + 850 μm), and

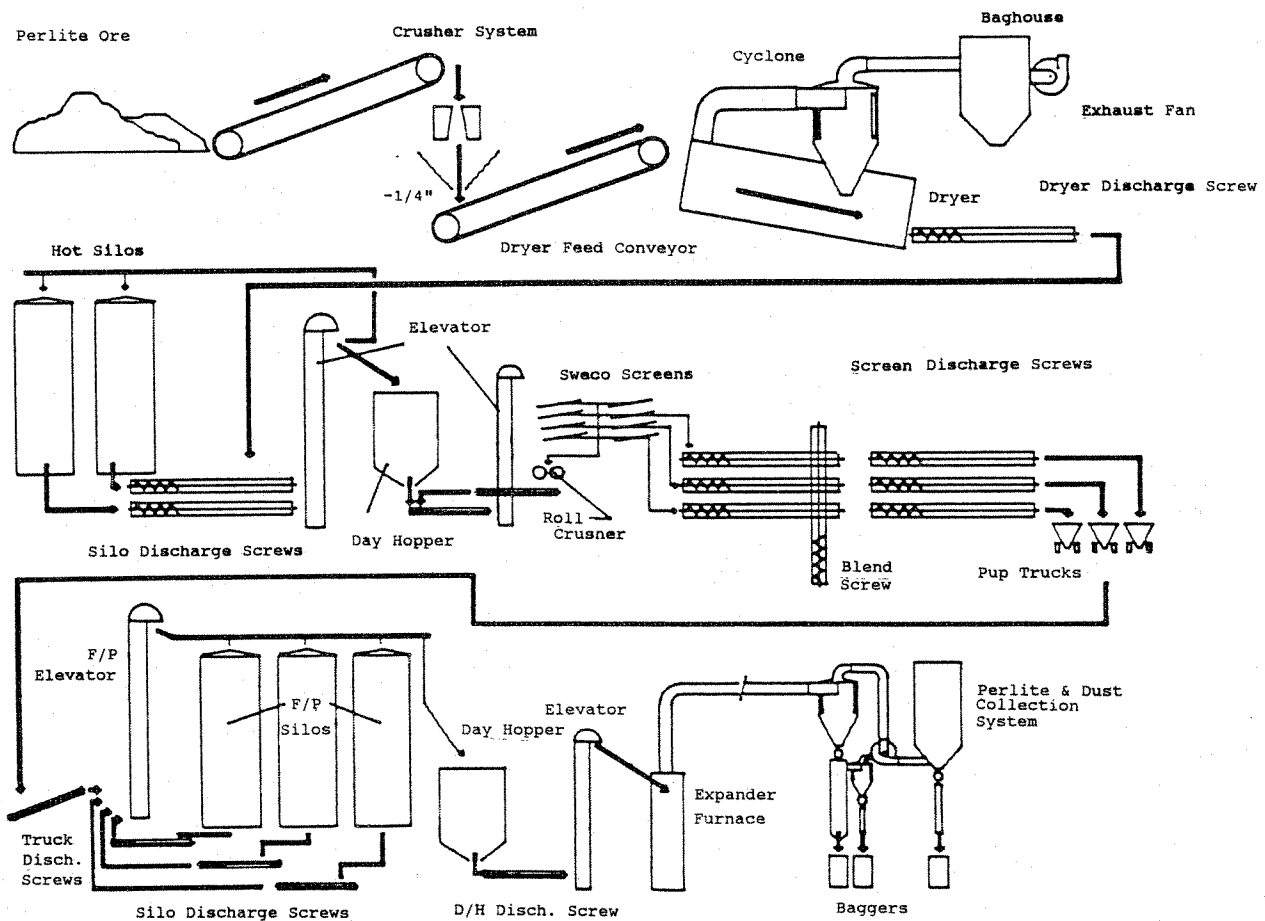

Figure 1. Aurun Mines Ltd., Pacific Perlite Division - flowsheet.

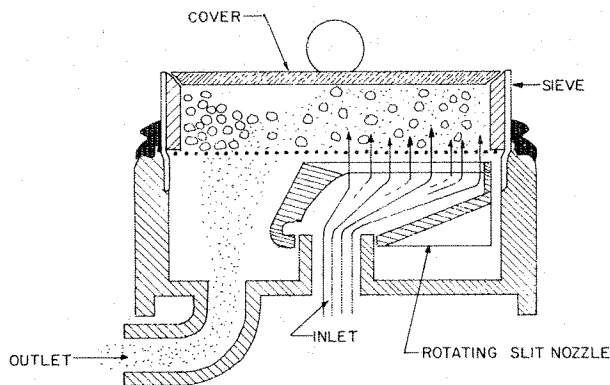

Figure 2. Cross section through Alpine Airjet Sieve Head.

-20 + 100 mesh (-850 + 150 μm) (Turner, 1985b).

The +100 mesh split was approximate only as dictated by dust collection equipment.

Expansion is the most critical aspect in determining the specific properties of each perlite product from each ore type. Expansion is attributed to softening of the aluminosilicate perlite rock (at 780 - 1100°C) followed by rapid volatilization of the combined water (of from 1 to 5%) to produce a "foam" that solidifies into a porous honeycomb structure of lightweight particles. Furnace variables such as the preheat temperature of the ore; the combined water content present at the attainment of softening temperature; the rate of heating to a temperature in excess of the softening temperature and the subsequent rate of cooling; the size distribution and nature of the perlite particles fed, can critically affect the degree of expansion, the extent of shattering and furnace problems such as perlite sticking to furnace walls. Optimal conditions are unique to each particular perlite ore. Stein and Murdock (1955) concluded that the degree of expansion is proportional to the temperature achieved in excess of the softening temperature. These same authors also concluded that the lower the softening temperature of perlite, the "more lively" was the perlite to expansion. Although such an array of control parameters would seem to demand sophisticated instrumentation such is not generally the situation. Furnace operators develop skills on the job to produce marketable perlite products. Few details of commercial furnace operations are ever published.

The finest perlite filter aid materials, which must be closely sized and only a few microns in average size, for efficient clarification of beverages such as beer and wine, require some comminution following expansion. Few details are published on this technology. To achieve the thinnest foam-bubble walls, higher temperatures and longer retention times in the furnace must be achieved to make the softened perlite more fluid. This would correlate to higher expansion factors and higher specific surface areas (which normally reside in the region of 1 square metre per gram (Barnes, 1961). Close temperature control is desirable since too high a temperature makes the perlite too fluid and it sticks to the walls of the furnace. This process is known as clinkering.

The Aurun expansion plant used a vertical furnace approximately 0.75 metres in diameter by 4.5 metres

high. The furnace was insulated inside with a perlite-containing refractory to improve heat containment and permit higher throughput. The furnace was fired with high pressure natural gas and all the necessary air was aspirated in. Furnace temperatures and airflows were regulated to control product quality.

Fines drawn off all three major product lines could be used for filter aid. Probably the best filter aid, at least for low pressure or vacuum filter use, came from expansion of the finer cryogenic feed stock which was given near maximum expansion in the furnace. For high pressure use, filter aid with thicker, more robust foam walls might be required to prevent collapse of the precoat cake structure. Close sizing of the filter aid particles also resulted in a more open structure having lower fluid drag or cake resistance.

CHARACTERIZATION OF AURUN FILTER AIDS

Aurun Mines Ltd. filter aids were used mainly for water filtration in aquariums and in swimming pools. Product data sheets indicated their UF100 grade was nominally 50 per cent 180 μm and 8 to 10 per cent 45 μm . Our analyses indicated that their UF100 product was considerably finer than this. Aurun UF50 grade was very fine (approximately 90 per cent 38 μm). Bulk dry density of Aurun filter aid varied from approximately 6 to 10 pounds per cubic foot (97 - 162 kg/m^3).

SIZING OF PERLITE FILTER AID

Screen Analyses: Rotap size analysis of the very fine fractions of expanded perlite using Perlite Institute Standard Test Method PI 115-77 (for example) with 5 minutes sieving time was found to introduce significant errors. In our studies, an Alpine Air Jet Sieve gave

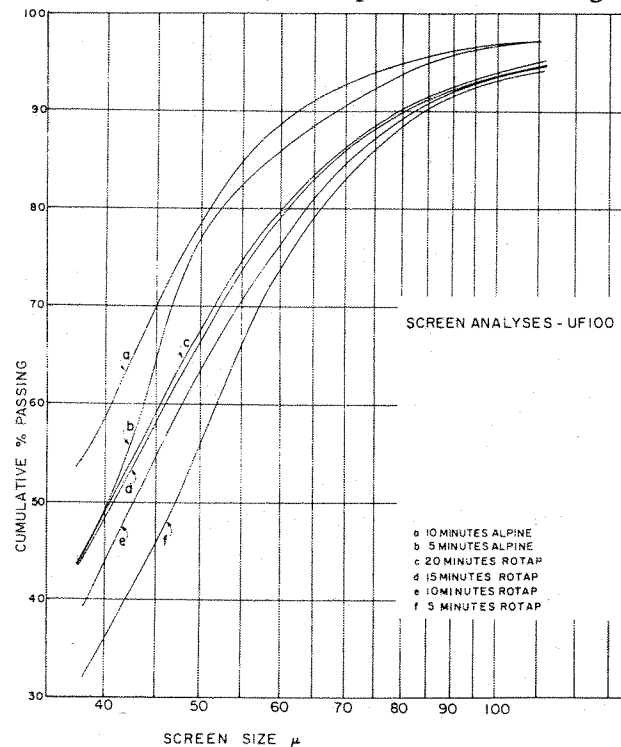

Figure 3. Comparisons of different screening techniques on UF 100.

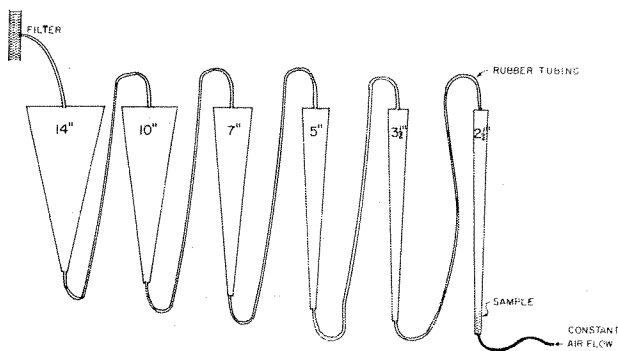

Figure 4. Haultain infrasizer.

superior size analyses down to 400 mesh ($38\ \mu\text{m}$) with insignificant comminution effects. Figure 2 is a schematic drawing of an Alpine Air Jet Sieve apparatus (Lauer, 1966). Figure 3 compares standard RoTap and Alpine Air Jet Sieve analyses of the same expanded perlite filter aid material at different sieving times. Our results indicated that the standard PI 115-77 technique introduced significant errors. The Air Jet Sieve was more efficient since screen undersize was swept up from the bed of particles and then screened through a more open section of the screen via an airstream emanating from a rotating plenum.

Hydraulic Classification was attempted using a Warman Cyclosizer (Kelsall, 1963). This equipment efficiently classifies many particulates into 5 size fractions between $50\ \mu\text{m}$ and $10\ \mu\text{m}$ using a series of closed apex inverted hydrocyclones. The high aqueous drag coefficients of typical expanded perlite particles made this technique inappropriate for subsieve sizing of this material.

Air Classification of expanded perlite proved effective for subsieve size analysis. A rather antiquated Haultain Infrasizer (see Figure 4) worked effectively (if slowly) in classifying fine dry perlite down to approximately $15\ \mu\text{m}$ in particle diameter (Haultain and Smith, 1955). Infrasizing data overlapped with Elzone electronic sizing as shown in Figure 5.

Electronic Sizing of particles down to approximately 2 micrometres in diameter was conducted using an Elzone Cycloscope (Berg, 1965). Electron microscopy provided a check on this technique.

Figure 5 shows continuous size analyses of several Aurun filter aid products using a combination of the above techniques. This demonstrates that Aurun's "UF 100" product was approximately 97 per cent $50\ \mu\text{m}$ and

TABLE 1
SPECIFIC SURFACE AREAS OF PERLITE FILTER AIDS

FILTER AID	SURFACE AREA, m^2/g
UF 100 (current)	1.3
UF 50 (current)	2.0
Aldergrove pilot plant product	0.7

28 per cent $20\ \mu\text{m}$. Their UF50 product was considerably finer being 97 per cent to 100 per cent $50\ \mu\text{m}$; 60 per cent to 98 per cent $20\ \mu\text{m}$ and 25 per cent to 65 per cent $10\ \mu\text{m}$, depending on whether horticultural or cryogenic grade materials were the main products being expanded.

Specific Surface Areas were measured using a Quantasorb B.E.T. technique (Quantasorb Operator's Manual, Quantachrome Corporation, Greendale, NY). Results are presented in Table 1.

Particle shapes and sizes were also examined using a scanning electron microscope (S.E.M.) after sputtering gold films onto the perlite to make it conductive. S.E.M. microphotographs were particularly useful in monitoring furnace expansion conditions and comminution techniques for producing suitable cellwall thicknesses and ensuring retention of three dimensional shapes.

Figure 6 shows several SEM micrographs of various Aurun filter aid products illustrating the above points. Figure 6A shows typical appearance of a -270 + 325 mesh ($-53\ \mu\text{m} + 45\ \mu\text{m}$) fraction of Aurun's UF100 filter aid. One can readily observe a uniform wall thickness of 1 to $2\ \mu\text{m}$ and retention of 3D-fragments of a honeycomb structure which would be expected to result in low pre-coat filter cake resistance. Figure 6B shows another micrograph of -325 mesh ($-45\ \mu\text{m}$) Aurun perlite filter aid whose average wall thicknesses were 2 to $3\ \mu\text{m}$ as a result of furnace adjustments. Such material resisted crushing better in high pressure filter aid applications. Figure 6C shows typical UF50 filter aid by-product which resulted from furnace expansion to produce primarily cryogenic grade perlite. Note that the cell walls were very thin and

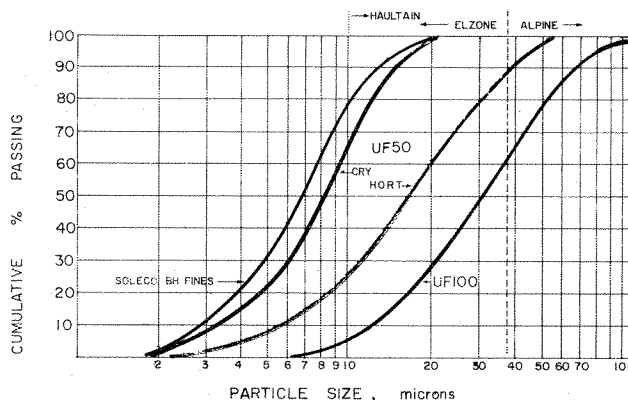

Figure 5. Size analyses of perlite filter aid materials.

the fragments had slightly less 3-dimensional structure than that shown in Figure 6A. Figure 6D shows unsized pulverized perlite illustrating almost complete elimination of the triangular 3D cell structure. Such flat shapes should be expected to exhibit poor filter aid characteristics and in fact did show high flow resistance. Far more gentle comminution was obviously required to produce a high quality fine filter aid product.

PRECOAT AND BULK FEED FILTRATION TESTS

A conventional bomb-type constant pressure filtration test apparatus similar to the filter in Figure 7 was constructed in our shops from drawings supplied by US Filter Corporation (drawing Number 12-910). To date, in

excess of 150 tests on a wide variety of filter aid materials have now been completed using this apparatus.

Our bomb filtration tests were generally conducted by adding a known weight of filter aid to 4 000 millilitres of distilled water at 22°C; pressuring the slurry to a fixed pressure (usually 100 kPa) and then timing the period required to collect each successive 100 millilitres of filtrate. At the conclusion of the filtration, air was blown through the cake whose thickness was then measured to within 0.1 centimetres. The filter cake area was 4.63 square centimetres. The cake was then weighed both wet and after thermal drying to obtain approximate measures

of wet density plus filter aid cake makeup. Normally 80 to 90 per cent of the added filter aid was recovered as cake.

Specific cake resistance α was calculated from plotting results and using the Ruth equation:

$$t/V = 1/K \cdot (V + V_i)$$

where:

V = filtrate volume at time t (cm^3)

K = Ruth constant $2PA^2/\mu\alpha C$

μ = filtrate dynamic viscosity, $\text{Pa}\cdot\text{secs}$

α = specific cake resistance, m^{-1}

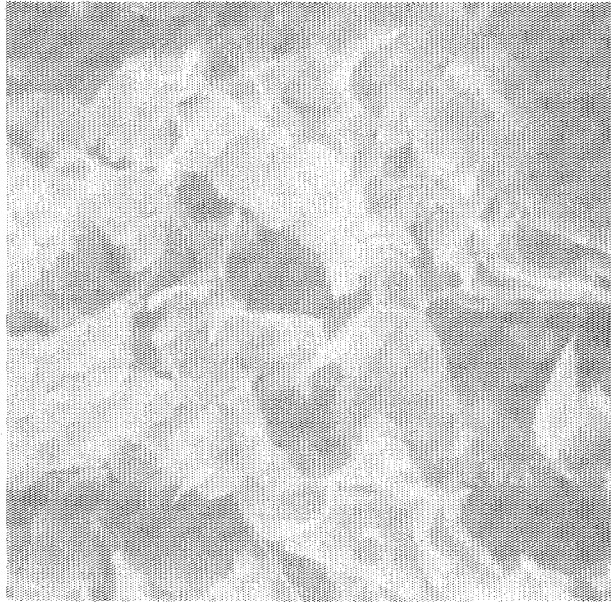

6A

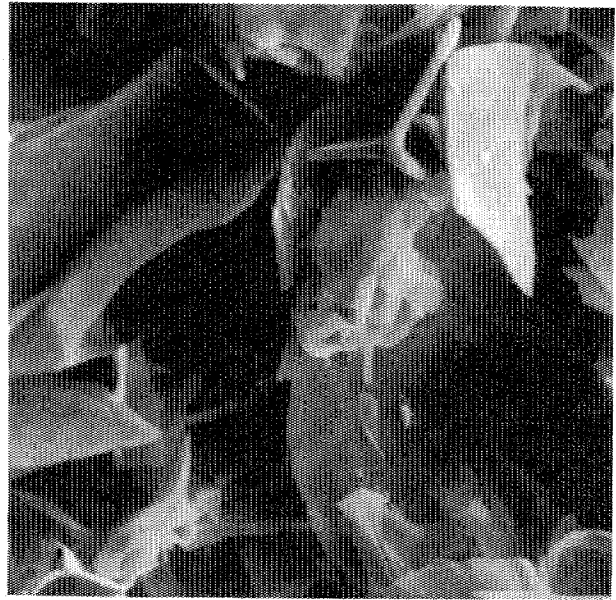

6B

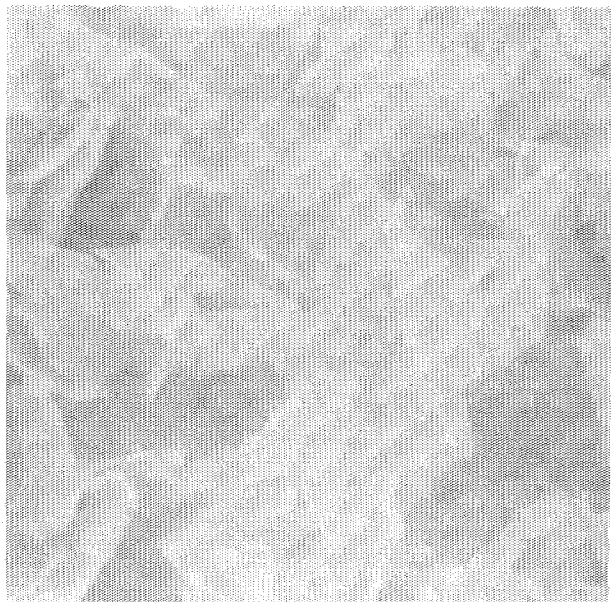

6C

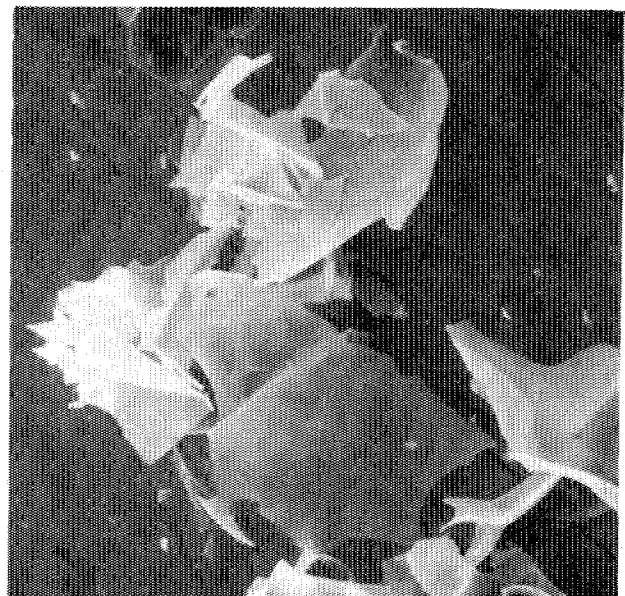

6D

Figure 6. Scanning electron micrographs of expanded perlite materials submitted for testwork. A. -270 + 325 mesh Aurun UF 100; B. -325 mesh Aurun filter aid with thicker walls; C. UF 50; D. oversized perlite pulverized too severely.

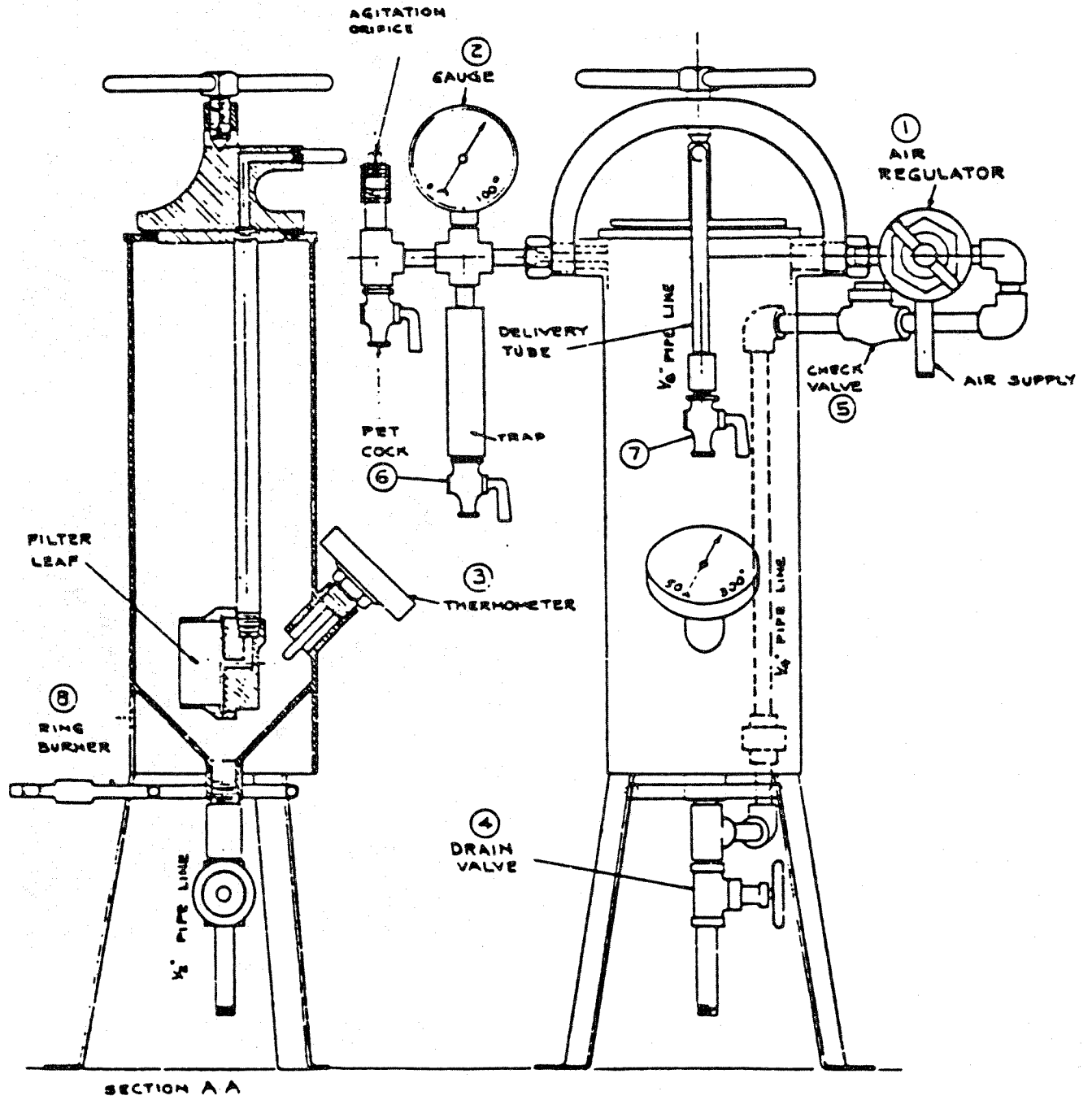
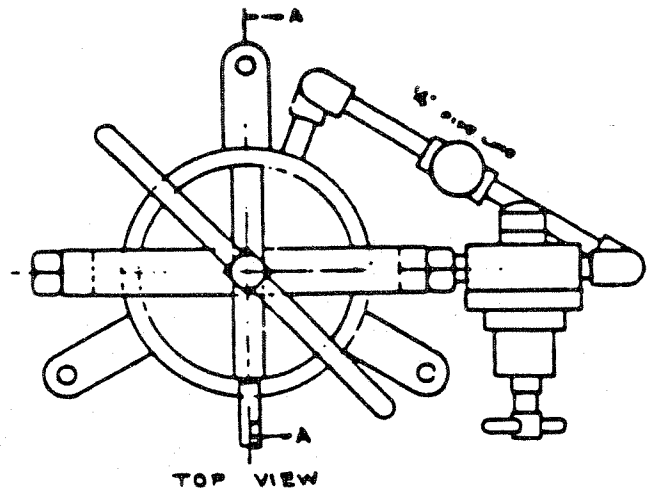

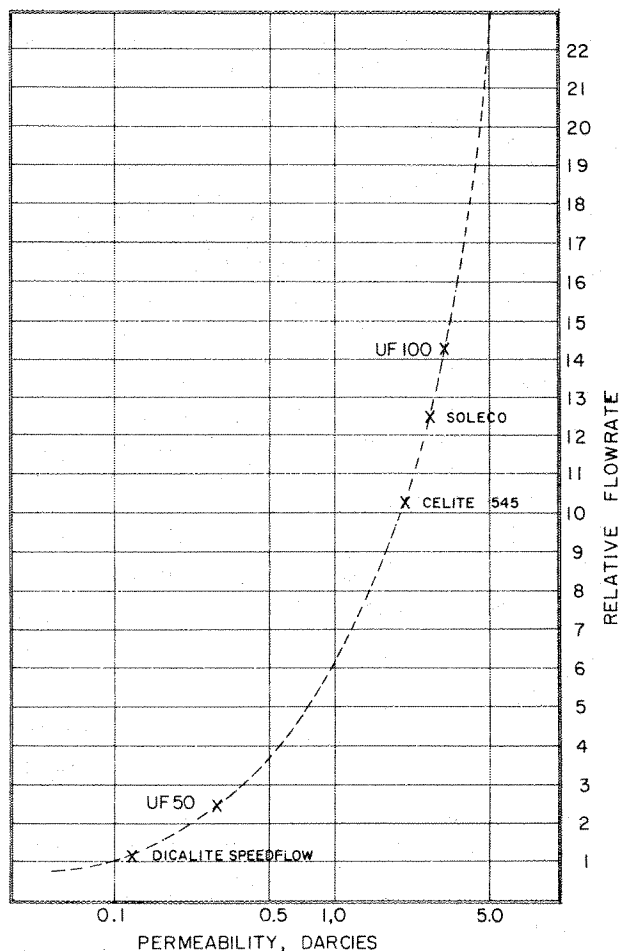

Figure 8. Permeability vs. relative flowrate for filter aids.

C = slurry concentration, kg/m^3

P = filtration pressure, Pa

A = filter area, m^2

$V_f = A R_m$

R_m = medium resistance

Theoretically, plotting t/V vs V should yield a straight line of slope $\mu\alpha C/2PA^2$ and intercept $\mu R_m/PA$. Normally such a plot is actually slightly concave upwards.

The specific cake resistance α was found to be a more easily determined parameter than the more commonly used "flow rate" used by most filter aid manufacturers when describing their products. The two are inversely related.

Testwork to date has centered on filtering both distilled water and synthetic "turbid" water.

PRECOAT FILTRATION TESTS

The bombfilter apparatus was used to conduct the majority of precoat filter tests both with and without body feed of additional filter aid. For most tests a dilute suspension of well dispersed bentonite in water at 0.1 grams per litre was used as a model turbid feed stock.

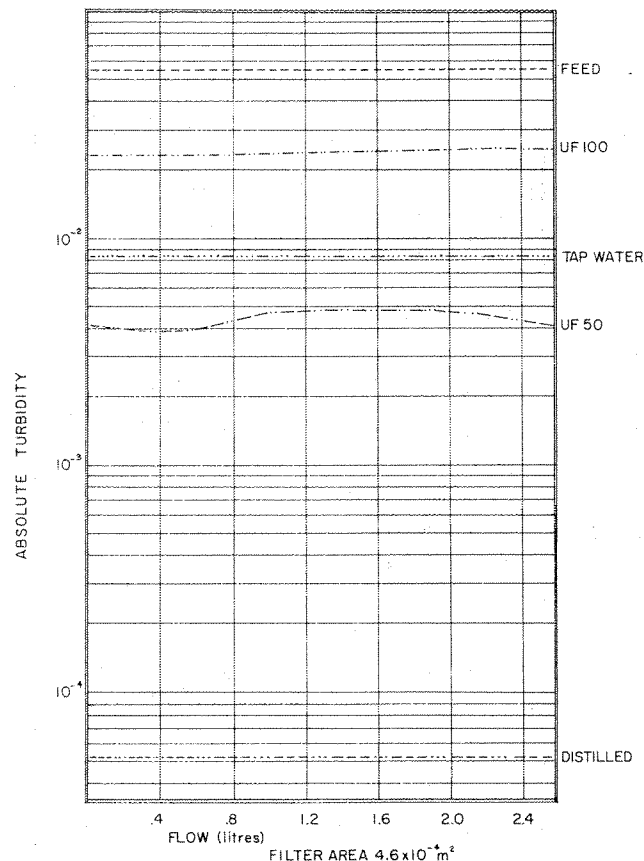

Figure 9. Precoat filtration of synthetically turbid feed water.

Clarification of this feedstock was monitored using a Brice Phoenix light scattering photometer.

Figure 8 shows a typical plot of relative flowrate versus permeability for Aurun Mines Ltd. UF 100 and UF 50 filter aid products. Test results for Dicalite speedflow and Celite 545 and a Solico filter aid product are shown on this figure for comparison purposes. This figure illustrates clearly that these two Aurun products were well within the water filtration performance rating of other popular filter aid materials. Such was not always the situation. Bomb-filter testwork on some of the early filter aid products from the Aurun Aldergrove test expansion plant fell well off the curve.

Figure 9 shows light scattering measurements of absolute turbidities of artificially turbid water (labelled "Feed") and of the filtrates derived through UF 100 and UF 50 Aurun filter aids. Turbidity measurements on Vancouver tap water and distilled water are also shown for comparison. Approximate comparison of the absolute turbidities to the more popular Nephelometric Turbidity Unit (NTU) scale can be made as follows:

NTU	ABSOLUTE TURBIDITY
10	1×10^{-2}
5	2×10^{-3}
1	4×10^{-4}

Facing Page: Figure 7. Typical laboratory scale constant pressure "bomb" filter (from Alciatore, Nev and Bouvier "Correlations Between Constant Pressure Bomb Filter and Full-scale Plant Results" Filtration and Separation, September/October 1973 p.582)

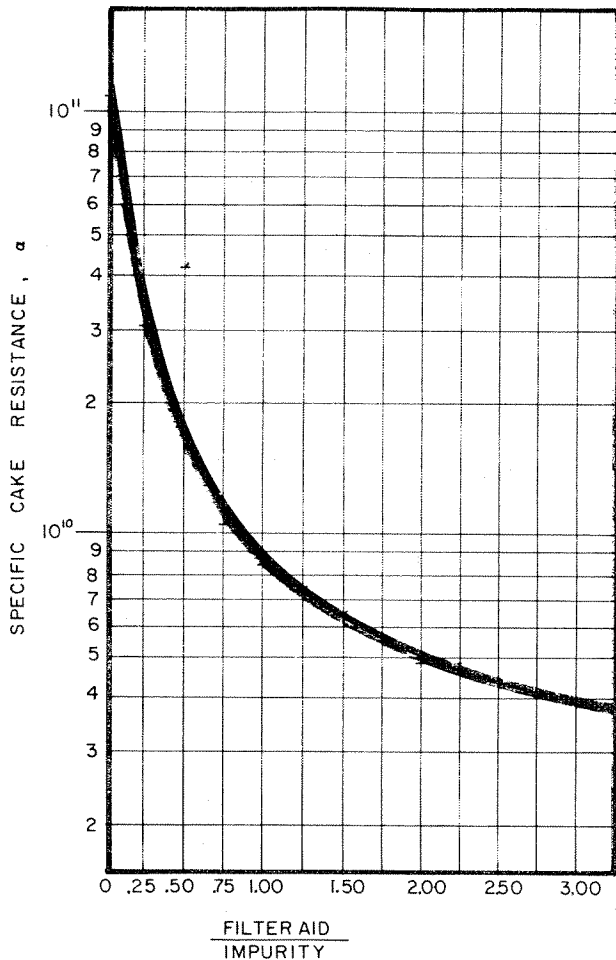

Figure 10. Influence of body-feed filter aid on specific cake resistance.

The UN target for the clarity of drinking water in developing countries is 1 NTU.

Figure 10 shows the influence of "body feed" filter aid in reducing specific cake resistance again using the synthetic turbid suspension of bentonite in water. Stock solutions of 0.1 gram per litre bentonite were filtered through precoat cakes of UF 100 initially 0.6 centimetres thickness, to provide these data. This figure clearly demonstrates the importance of achieving a reasonable ratio of weight of body feed filter aid to impurity weight. A 1.5:1 ratio is shown to reduce the resistance from an initial very high level of 1×10^{11} to 6×10^9 which is a more practical level. The specific cake resistance of clean water through a similar UF 100 precoat cake was 1.6×10^9 .

CONCLUSIONS

Perlite filter aid materials produced by Aurun Mines Ltd. could be tailored to meet a wide variety of either vacuum or pressure water filtration applications. Physical characterizations of filter aid materials by accurate sizing, scanning electron micrographs and pressure bomb filtration tests assisted Aurun Mines Ltd. in developing improved preparation and expansion technologies. Much more extensive testwork than that described above established clearly that Aurun Mines Ltd. was able to produce

filter aid products closely similar in performance characterization to other wellknown filter aids.

ACKNOWLEDGMENTS

Financial support of the Science Council of British Columbia and Aurun Mines Ltd. are much appreciated. Discussions and suggestions from John Chapman and Jack Boyde of Aurun Mines Ltd. and Gilbey Hewlett and John Rawle of the Vancouver Public Aquarium have also been appreciated. Thanks also for the typing by Debbie Craswell, Joan Milton and Marina Lee.

REFERENCES

- Barker, J.M. and Hingten, J.; Perlite Testing at the New Mexico Bureau of Mines and Mineral Resources; Presentation, *SME-AIME*, Albuquerque, N. Mexico, preprint, pages 85-420.
- Barnes, R.E. (1961): Perlite Industry; *AIME Trans*, 222, pages 180-183.
- Berg, R.H. (1965): Sensing Zone Methods in Fine Particle Size Analysis; *Mat. Res. and Stds.*, 5, pages 119-125.
- Chamberlin, P. (1985): Perlite; Chapter 12, in *SME Mineral Processing Handbook*, N.L. Weiss, ed., *AIME*, pages 29-16.
- Haultain, H.E.T., and Smith, W. Van H. (1955): The Mystery of Air Elutriation; *CIMM*, Bulletin, p.795-796.
- Kelsall, D.F. (1963): Design and Operating Characteristics of a Hydraulic Cyclone Elutriator; *Trans. Institute of Chemical Engineering*, 41, pages 84-95.
- Lauer, O. (1966): Grain Size Measurement on Commercial Powders; *Alpine, American Geographer*.
- Stein, H.A. and Murdock, J.B. (1955): The Processing of Perlite; *California Journal of Mines & Geology*, Volume 51, pages 105-116.
- Turner, L.M. (1985a): Perlite Processing and Quality Control; *SME-AIME*, Albuquerque, N. Mexico, preprint, pages 85-345.
- Turner, L.M. (1985b): NoAqua Perlite Mine; *Mining Magazine*, pages 46-52.
- Wilson, H.S., (1981): Lightweight Aggregates - Vermiculite, Perlite, Pumice - for Insulating Concretes; *CANMET*, Report 81-ISE.

ROCKS IN MOTION

By Donald F. Gunning

International Marble and Stone Co. Ltd.,
Surrey, B.C.

INTRODUCTION

This paper outlines the history and development of International Marble and Stone Company Ltd. (IMASCO), based in British Columbia, and its recent acquisition, Nanome Aggregates Inc. of Valley, Washington. The aim of this is to emphasize that the role of transportation in the industrial minerals industry is extremely significant.

IMASCO and Nanome are small producers by most standards (85 000 and 30 000 tonnes per year respectively), and serve regional markets with quite diverse product lines which are dictated by demographics and economics. Given small, single industrial mineral product demands within the region, highly specialized producing plants are generally not viable. IMASCO products include carbonate aggregate, sand, flour and fine white fillers, as well as quartzite and granite aggregate and sands.

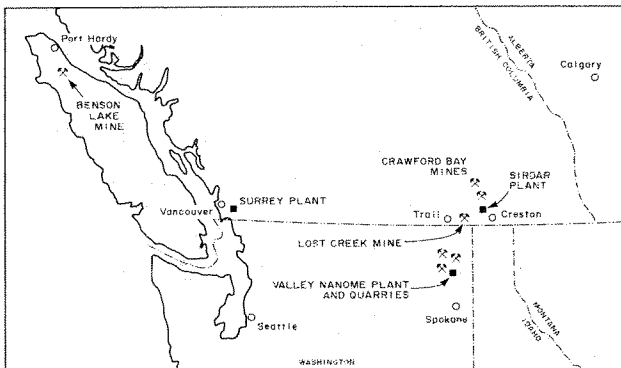

Figure 1. Location of three IMASCO plants and numerous quarries throughout British Columbia and Washington.

As with most industrial mineral operations, processes which most effect economics are transportation and materials handling, hence the title of this paper. To illustrate, the proportion of the total delivered cost-of-production for a major product, which involves physically moving the material from the quarry to the plant, through the plant and on to the customer, amounted to fully 50 per cent of the total mining and delivery costs (see Figures 1 and 2).

OPERATIONS

IMASCO was incorporated in 1961, comprising a crushing and screening plant at Sirdar, British Columbia, just north of Creston, and a head office in Calgary, Alberta. The main targeted market area was Alberta and the other prairie provinces. A viable granite deposit existed at the plant site.

Soon after its incorporation IMASCO discovered a white dolomite deposit at Crawford Bay, British Columbia about 40 kilometres north of Sirdar on the east side

of Kootenay Lake. This deposit became the mainstay for the Sirdar plant, permitting the production of white aggregates, sands and fillers. The stone is quarried underground by the room and pillar method. Rubble size rock is transported in fifth-wheel truck trailers, of over 30 tonnes capacity, to the plant at Sirdar. A CAT 980 loader is used underground to load the trucks.

The deposit is a coarse-grained white crystalline marbleized dolomite of the lower Cambrian Badshot-Mohican Formation within a sequence of calcitic and dolomitic marble, dolomite, calcareous schist and quartzites, all part of a complexly folded belt within the Kootenay Arc.

Two small pits for quartzite are also operated at Crawford Bay, and rubble-rock is trucked to Sirdar as well as dolomite. The deposits are steeply dipping, iron-stained quartzites of the Cambrian Hamill Group. The two resultant aggregate and sand products are sold as "Coppertan" and "Beige". Two other colour classifications, "Sunset" and "Pink Ice", are produced by means of elevated temperature surface-oxidation at the Sirdar plant.

A small underground granite quarry is operated at

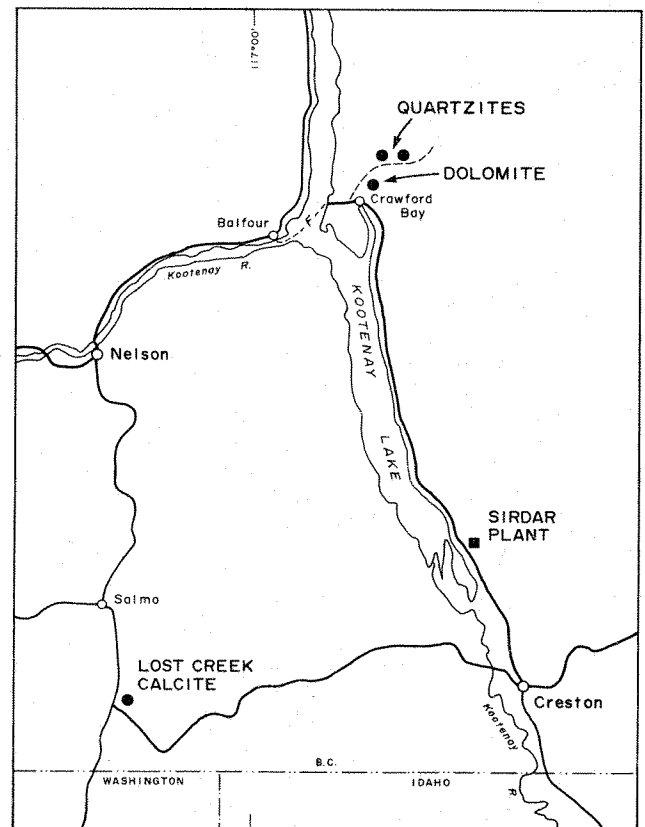

Figure 2. Detailed location map of IMASCO's Kootenay quarries and its plant in southeastern British Columbia.

the Sirdar plant. Aggregate and sand for decorative, precast and poultry grit markets are produced. The rock is part of the Bayonne Batholith, east of Duck Lake and consists roughly of equal parts of quartz, potash feldspar and plagioclase, with about 10 per cent biotite.

During the 1970s, IMASCO entered the fine-ground calcium carbonate filler market utilizing high-grade rock from the Salmo area. This is extracted by underground mining at Lost Creek. The deposit consists of massive recrystallized and marbled white limestone within the Reeves Member of the Lower Cambrian Laib Formation. Contact metamorphism is related to the intrusion of Nelson plutonic rocks - granite to granodiorite.

PLANT FACILITIES

The Sirdar plant commands a lovely view of Duck Lake, the fertile Creston Valley and the majestic Selkirk Mountains to the west. The mill sits on a hillside, and uses gravity for process purposes. The primary crushing section includes a jaw crusher, picking belt, screens and sand screws. Various intermediate products are stockpiled in this area for subsequent processing.

The plant comprises bin dryers, a second jaw, a cone, a Raymond mill, a cage mill, two ball mills, a rotary dryer, and numerous screens and air classifiers.

Packaging is achieved on four spout air-packers for sand and fillers, and custom built chute-baggers for aggregates. Product is also shipped both in one tonne bags and in bulk by truck and rail. Several truck loading docks and bays are available and pallets are manufactured at the site.

In the late 1970s, it was decided that a second IMASCO plant located on the Pacific Coast, was essential to better serve the markets for white sand, aggregates and fillers in Vancouver, Seattle, Portland and smaller centres. An exhaustive search for a viable deposit of white carbonate rock on the coast ensued, encompassing western Washington, Vancouver Island and the British Columbia Coast. These were interesting times indeed, involving the use of charter float planes and small boats, and a lot of West Coast rain forest bushwhacking. The west coast was most challenging; diamond drilling programs were carried out at several sites.

Exploration culminated with the opening of the IMASCO Benson Lake quarry on Northern Vancouver Island in 1984. The rock is very white, highly marbled limestone within the Upper Triassic Quatsino Formation. Contact metamorphism was caused by intrusions of Jurassic diorites and granodiorites.

Rock at the quarry is drilled, blasted and transported by payloader to a large jaw crusher and screening plant and then stockpiled for subsequent trucking to Port Alice. The quarry site is in remote, rough terrain and the centre of an active logging area. The rock is loaded onto a barge at Port Alice. The usual bargeload is 3 600 tonnes. It is towed to Vancouver and unloaded at a dock near the IMASCO Surrey plant and thence trucked to the plant stockpile.

The Surrey plant was built in 1984, after a thorough review of potential sites from Tacoma to Vancouver. It was designed to produce a full range of white calcium carbonate products from 1-1/2 inch aggregate down to 500-mesh fillers. The site encompasses four acres near the Fraser River and houses our new head office. The

IMASCO 100 AND 200 DOLOMITE (SIRDAR)

IMASCO dry ground dolomite ($\text{CaMg}(\text{CO}_3)_2$) fillers are produced at the Sirdar plant in 100 mesh and 200 mesh sizes. These fillers compliment our full range of white dolomite sands produced at the same plant and they are used in a wide range of manufacturing and formulating applications where a high MgO content, close sizing and high dry brightness are required.

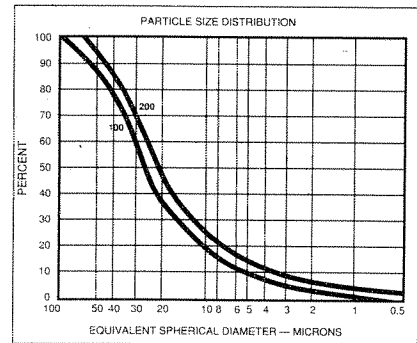

PARTICLE SIZE DATA (MICRONS)	
Top Cut (99.5%)	95
Mean Particle Size	30
Sub-micron Fraction	3%

PHYSICAL PROPERTIES

Dry Brightness — 93.05
Specific Gravity — 2.85
Mohs Hardness — 3.5-4.0
Solubility in H_2O — .001 to .002 %

TYPICAL CHEMICAL ANALYSIS

CaO	30.60%
MgO	19.84
SiO_2	3.53
Fe_2O_3	0.69
Al_2O_3	0.67
TiO_2	0.10
Na_2O	0.02
K_2O	0.27

IMASCO FINE GROUND CALCIUM CARBONATE (SIRDAR)

IMASCO fine-ground white calcium carbonate (CaCO_3) is available at our Sirdar plant in four sizes: 3H, 4H, 5H and 6H, corresponding to the Hegman grind scale. These products are high-quality dry-ground fillers for use in the coatings, plastics, paper and other manufacturing industries where consistent sizing, chemical purity and high brightness are required. IMASCO 6H is approved by the National Sanitation Foundation for use in the manufacture of potable PVC pipe.

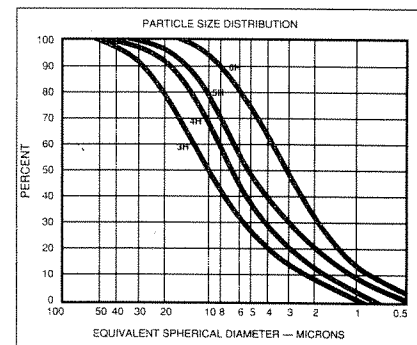

PARTICLE SIZE DATA (MICRONS)				
Top Cut (99.5% minus)	44	35	24	15
Mean Particle Size	10.0	7.0	5.5	3.2
Sub-micron Fraction	3%	4%	10%	14%

PHYSICAL PROPERTIES

Dry Brightness — 93.9 (6H)
Specific Gravity — 2.7
Mohs Hardness — 3.0
Solubility in Water — .001 to .002 %

TYPICAL CHEMICAL ANALYSIS

CaO	53.78%
MgO	1.0
SiO_2	1.33
Fe_2O_3	0.23
Al_2O_3	0.34
TiO_2	0.01
Na_2O	0.01
K_2O	0.01

IMASCO FINE GROUND CALCIUM CARBONATE (SURREY)

IMASCO fine-ground white calcium carbonate (CaCO_3) is available at our Surrey plant in four gradations: 3HX, 4HX, 6HX and 7HX, corresponding to the Hegman scale. These products are high quality dry-ground fillers for use in the coatings, plastics, paper and other manufacturing industries where consistent sizing, chemical purity and high brightness are required. These four products as well as our coarser 100X and 200X meet the requirements of the Food Chemicals Codex for "Limestone — Ground" and are approved for functional use in foods. Our 6HX and 7HX products are also approved by the National Sanitation Foundation for use in the manufacture of potable PVC pipe.

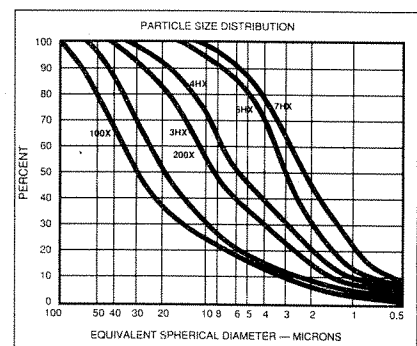

PARTICLE SIZE DATA (MICRONS)						
Top Cut (99.5% minus)	95	70	44	30	15	12
Mean Particle Size	30	21	8.8	5.8	3.0	2.2
Sub-micron Fraction	3%	5%	3%	10%	18%	24%

PHYSICAL PROPERTIES

Dry Brightness — 94.5
Specific Gravity — 2.7
Mohs Hardness — 3.0
Solubility in H_2O — .001 to .002 %

TYPICAL CHEMICAL ANALYSIS

CaO	53.67%
MgO	1.73
SiO_2	0.56
Fe_2O_3	0.06
Al_2O_3	0.11
TiO_2	0.01
Na_2O	0.02
K_2O	0.01

Figure 3. Specification sheet for IMASCO filler products, both dolomite and calcium carbonate. Data is representative of recent testing and typical of normal production.

rock is retrieved from the stockpile, crushed in a hammer mill and conveyed up and into surge tanks, then later withdrawn, dried, and ball-mill ground after the screening-off of aggregates. Several sand and flour sizes are produced, as well as four fine-ground grades down to a 2-micron mean particle size. Products can be shipped bulk or bagged, and include aggregate, sand fillers, and a proprietary premix stucco with custom colours. MASCO products are sold throughout Western Canada and the Northwest United States of America (see Figure 3).

Just over 2 years ago, Nanome Aggregates Inc. was acquired by IMASCO, this is a well established producer of coloured dolomite terrazzo chips, sand and fillers, located at Valley, Washington, just north of Spokane. Nanome has been in business for over 30 years and ships natural coloured dolomite terrazzo chips all over North America and serves regional markets for marble chips, dolomite line, white sand and fillers. Customers include precasters, manufacturers, agricultural distributors, contractors and numerous other industries. Nanome operates 9 or 10 different quarries and trucks rock to the plant at Valley, as required. Their "Superwhite" dolomite quarry is at Kelly Hill, north of Kettle Falls, on the west side of Roosevelt Lake. The rock is of high purity and brightness. "Sunlit White" rock from a quarry near Chewelah is used for lower brightness applications. The Cream/Botte quarry is just west of Chewelah, and the Watermary quarry is just west of Valley. The Nanome plant at Valley consists of a jaw crusher, screens, an

impact crusher, and a Raymond mill. Rock from each quarry is stored in a separate bunker prior to processing. Nanomes' colourful terrazzo chips can be found in airports and buildings all across North America. Product is shipped bulk by truck or rail, or in a variety of bags.

Most of the Nanome quarries are located in Cambrian, Lower Cambrian or Precambrian rocks and are principally dolomite. Several comprise the Stensgar dolomite formation. There are no underground operations.

SUMMARY

IMASCO has maintained a strong growth rate over the past decade and continues to develop new products to sustain this trend. Nanome is doing the same. Only in this way can we stay profitable in the face of volatile business cycles and increased competition. The challenges are many, but we believe we can continue to serve western industrial mineral markets effectively for many years to come.

ACKNOWLEDGEMENT

I want to thank Dave Holmes of Denver for some of the geological information I have used.

AMMOLITE, AN ORGANIC GEMSTONE FROM ALBERTA

By Rene Vandervelde

Korite Minerals Ltd., Calgary, Alberta

INTRODUCTION

It is a privilege to be able to address this Forum and to thank the organizers for extending the invitation. Although I was asked to talk about ammolite, I will touch very briefly on other gemstones in Canada as well. Gemstones are produced in Canada but among industrial minerals they do not rank very high. There are two rhodonite mines, one in the Yukon and one on Salt Spring Island, British Columbia. Jade is found in British Columbia and the Yukon. Amethyst is reported from various locations: Nova Scotia, New Brunswick, Ontario and British Columbia. Apatite is found in Ontario and Quebec. Hessonite garnet has been mined at Asbestos, Quebec for years. The newest gemstone to be produced in Canada is the subject of this paper: ammolite from southern Alberta.

The subject can be approached from several points of view: historical, geological, gemological and commercial. I will attempt to review all of them, but I must tell you that my qualifications in each are limited.

HISTORICAL

Ammolite was first described in 1917 by Dr. D.B. Dowling of the Geological Survey of Canada. Further studies by GSC geologists, including Dr. Loris Russell, Drs. Link and Childerhose, and Dr. Archibald Stalker continued up to the mid 1960s, when the Nanton rock club started to assemble stones from surface collected ammonite shell. Some of these stones reached Calgary where they attracted the attention of several people. Ammolite Minerals Co. was formed in 1969 and lasted 2 years. Calcentine Ltd. was formed in 1974 and lasted till 1981. Cavecrafts Co. in Drumheller and several individuals worked with surface collected ammonite shell. However, only Calcentine provided a decent quality stone, which was researched and developed by Santo Carbone who at the time worked for the GSC.

Korite Minerals Ltd. was formed in 1977. It was the only company which from the start owned the mineral rights. In 1988 the Alberta Government opened up all of the Bearpaw Formation outcrop on Crown lands for bids and a flurry of activity resulted in over 200 parcels being leased to corporations and individuals. We estimate that over two dozen test pits have been dug, most of these on the St. Mary River, but after 25 years of exploration and all these test pits, only one active mine exists.

GEOLOGICAL

Ammolite has been formed by the compression and alteration of ammonite shell. Ammonite fossils are found in abundance and variety in the Late Cretaceous Bearpaw Formation of Alberta, but only two species produce gem material; *Placentiaceras meeki* and *Placentiaceras intercalare*. The ammonite collapsed under a heavy sedimentary overburden and we now find it as a crushed sheet of ammonite shell in ironstone concretions, which we dig with backhoes in shale beds to a depth

of 50 feet. There are mineral-rich bentonite layers in the shale, and some of this mineralization must have been transferred to the ammonite shell because we find that some of our stones contain twice as much iron or copper as others. As Dr. Pough in his article in *Lapidary Journal* says: "A more reasonable premise is that the spectrum spreading spacing responsible for nacre's iridescence has been altered by burial, compression and alteration".

Although the Bearpaw Formation is very extensive, only in the area between the Red Deer River and the Milk River in Alberta does one find gem quality material. Even here, conditions vary widely from location to location. We have taken ammolite to every continent over the past 12 years. It appears to be a unique phenomenon of Alberta.

STRATIGRAPHY OF THE BEARPAW FORMATION

The Bearpaw Formation is recognized throughout central and southern Alberta, and extends into southwestern Saskatchewan, North and South Dakota and Montana. It is correlated with the type locality in the Bearpaw Mountains of Montana (Hatcher and Stanton, 1903). Its age is considered to be late Campanian to early Maestrichtian. The formation consists of grey, thin bedded to fissile marine shales, interbedded (in part) with several distinguishable coarse-grained sandstones that weather reddish brown. Thickness of the Bearpaw Formation in southern Alberta varies from 600 feet (180 metres) to 1100 feet (350 metres). Bentonite and ironstone concretionary beds are numerous. Portions are highly fossiliferous.

On the St. Mary River, the Bearpaw was measured at 720 feet (220 metres) in thickness (Link and Childerhose, 1931). Its basal boundary is with the uppermost member of the Oldman Formation, the "Lethbridge coal measures". The transition is marked by grey sandy shales interbedded with two major coal seams. The lower seam is a commercial coal deposit 6 feet (2 metres) thick. An *Ostrea coquina* overlies the highest coal seam. A brown weathering ferruginous sandstone bed is recognized here as the top of the Oldman Formation.

The Bearpaw Formation can be divided into two parts. The lower one-third contains well bedded dark shales devoid of sands. The upper two-thirds contains three distinct sandstone units separated by shales. Twenty-two bentonite beds are present in the formation, as well as several ironstone and calcareous concretionary zones (Link and Childerhose, 1931).

The lower shale member is distinguishable by its less sandy and fossiliferous nature. It is described as 210 feet (65 metres) of dark grey, well bedded shales. Six thin bentonite beds are present including one 6-inch (0.15 metre) bed approximately 40 feet (12 metres) above the base.

The upper member in the Bearpaw includes three sandstone units termed the Magrath, Kipp and Rye Grass sandstones. The lowest is Magrath sandstone, a

sand/shale aggregate 62 feet (19 metres) thick characterized by an abundance of well preserved *Arctica ovata*. A 100-foot (30 metres) fossiliferous shale separates the Magrath from the second sand unit, the Kipp Sandstone, a sand/shale aggregate 40 feet (12 metres) in thickness. It is characterized by an abundance of *Placentoceras*. The uppermost sand unit, the Rye Grass sandstone, is separated from the Kipp sandstone by 140 feet (43 metres) of dark grey, often sandy shales. The Rye Grass is a 90-foot (27 metres) predominantly bluish-grey sandstone, which differentiates it from the other sandstone members. The upper beds in the Bearpaw are sandy shales with an abrupt transition to the massive, coarse grey sandstone of the Blood Reserve Formation.

GEMOLOGICAL

Gemologically, the composition of ammolite is as follows:

aragonite	96%
strontium	.48%
iron	1.00%
silica	1.00%
titanium	.6%
aluminum	
barium	
chromium	
copper	
magnesium	
vanadium	

Aragonite alters to calcite in most rocks older than Pleistocene age. Although the Bearpaw Formation is of Late Cretaceous age, the aragonite appears to be entirely unaltered. The tightly packed shale beds and the bentonite layers seem to have protected the ammolite well.

The colour effect of ammolite is caused by the diffraction of white light into its constituent colours on the subsequent layers of ammonite shell. Red, green and orange colours are common, while blue colours are extremely rare.

The gemstone which has a mineralogical makeup similar to ammolite is the pearl. Both are organic in nature, formed by the secretion of nacre by molluscs. In appearance ammolite is most often compared to black opal, because of the play of colour and the iridescence of the polished stones.

COMMERCIAL

Sales of ammolite over the past 15 years have increased by about 25 per cent per year. Korite Minerals started from a very small base and sales are highly concentrated in a few markets. We are still developing new markets very slowly, but in a few years the availability of good quality rough may limit the growth of our markets.

Prices for ammolite have kept pace with inflation, but not with gemstone prices (except for diamonds). The price of diamonds was highly inflated compared to the availability of supplies in the late 1970s. Prices for a carat top colour stone tumbled from \$55 000 U.S. to \$15 000 U.S. in 1981. Since then prices have recovered, but sapphires, opals, rubies and emeralds have moved much faster than diamonds. Considering the rarity of ammolite it is grossly undervalued, but this will probably adjust

itself as demand increases and as more responsible players enter the industry.

There are very large quantities of ammolite buried under the southern Alberta plains. Some estimates are in excess of 1 billion ammonites. The problem is that ammonites are very widely dispersed. Only one commercial concentration has been found to date, but it should be remembered that the ammolite industry is only 15 years old. If we compare its production value to that of the opal industry the ratio is close to 100 to 1, but 200 years ago the opal industry was also in its infancy. Experience, better techniques, financially stronger participants, a larger market and a better price will all help to make ammolite a significant industry for Alberta.

REFERENCES

- Arem, J.E. (1987): Colour encyclopedia of gemstones; *Van Nostrand Reinhold*, New York.
- Arkell, W.J., Kummel, B and Wright, C.W. (1957): Mesozoic Ammonoidea; in Moore, R.C., *Treatise on Invertebrate Paleontology, University of Kansas Press*, pages 180-1464.
- Crowningshield, R. (1977): Gems and gemology; XV (10), pages 312.
- Fox, D.L. (1966): Pigmentation of molluscs; in Wilbur, K.M. and Youge, C.M. (ed.), *Physiology of Mollusca II, Academic Press*, New York, pages 249-250.
- Gubelin, E. (1980): Ammolite Eine never fossiler schmuckstein; *Lapis*, Vol. 4, No. 4, April 1980; Munich, pages 19-24.
- Kennedy, W.J. and Cobban, W.A. (1976): Aspects of ammonite biology biogeography and biostratigraphy, in Special papers in Paleontology, No. 17, *The Paleontological Association*, London, pages 94.
- Kraus, P.D. (1981): Korite from Alberta; *Lapidary Journal*, January 1981, pages 1994-1996.
- Link, T.A. and Childerhose, A.V. (1931): Bearpaw shale and contiguous formations in the Lethbridge area, Alberta; *American Association of Petroleum Geology, Bulletin*, Vol. 15, No. 10, pages 1227-1242.
- Pough, F.H. (1986): Ammolite; *Lapidary Journal*, January 1986, pages 35-41.
- Sinkankas, J. (1976): Gemstones of North America; Vol. 2, *Van Nostrand Reinhold*, New York, page 494.
- Stalker, A. Mac S. (1953): Surficial geology of southwestern Alberta; *Alberta Society of Petroleum Geologists*, pages 15-22.
- Ward, F.H. (1986): Macro - Paleo Bearpaw Formation, southern Alberta; *Canadian Society of Petroleum Geologists*, pages 31.
- Webster, R. (1975): Gems; 3rd edition, *Newnes Butterworths*, London, page 931.
- Wight, W. (1981): Korite - Fossil ammonite shell from Alberta, 1981; *The Journal of Gemology*, Vol. XVII, No. 6, London, pages 406-415.
- Zeitner, J.C. (1978): Callentine is ammolite is nacre; *Lapidary Journal*, Vol. 3, pages 622-628.

FOUR MARL DEPOSITS WITHIN THE SKEENA RIVER VALLEY, NORTHWESTERN BRITISH COLUMBIA (103I/16W, 103P/1W, 93M/5E)

By M.L. Malott

B.C. Ministry of Energy, Mines and Petroleum Resources, Victoria, B.C.

KEYWORDS:

Industrial minerals, marl, bog lime, Skeena River, Buccaneer of the North, Gee Kid, Robinson Lake, Wilson Kettle

INTRODUCTION

Marl deposits have been known from the Skeena drainage, in the Terrace-Hazelton region, since the early 1930s. Several deposits were identified at that time as possible sources of lime for neutralizing acidic soils. Although only minor amounts of marl have been mined, these occurrences have received more attention recently. Marl has a potential use in neutralizing acid mine drainage and acidic cycles of mill processes.

The four marl deposits discussed in this article, Buccaneer of the North, Gee Kid/Lime Lake, Wilson Kettle and Robinson Lake are all within a few kilometres of the Skeena River between Terrace and Old Hazelton (Figure 1). The term marl is used in this report to indicate a friable mixture of greater than 40 per cent calcium oxide (70 per cent calcium carbonate equivalence) together with insoluble detritus and noncarbonate plant material. The colour is usually white or buff, but grey to brown or black shades occur as the organic content increases. Bog lime is an alternate term for marl.

REGIONAL GEOLOGIC SETTING

The Skeena drainage lies within the Stikine Terrane,

a component of the Intermontane Belt. Lower Jurassic volcanic rocks outcrop over a large area to the south of the marl deposits. In forming the Bowser basin to the north, Jurassic and Lower Cretaceous siltstones, argillites and greywackes underlie a veneer of Quaternary Fraser glaciation related landforms which host the marl deposits discussed in this article. The Fraser glaciation beginning 25 000 to 30 000 years ago, was the most recent glacial advance (Clague, 1984). During this time, coalescent piedmont glaciers moved southwestward through the study region. Commencing approximately 15 000 years ago, as the glacial age waned, the coalescent ice mass downwasted forming several separate glaciers within the Skeena Valley. These isolated glaciers gradually lost mobility and stagnated, leaving behind, as they melted, fluvio-glacial deposits and other landforms such as kettle depressions and kame terraces.

BUCCANEER OF THE NORTH MARL DEPOSIT (MINFILE 103I 001)

A marl deposit known as Buccaneer of the North (or Bockner of the North), occurs 46 kilometres north-northwest of Terrace and approximately 1 kilometre west of the Canadian National Railway Ritchie siding on the west side of the Skeena River (Figure 1). Access is by crossing the Skeena River from a sand bench beyond the north edge of the Kwa-tsa-lix Indian Reserve 4 at Klootch Canyon. A trail on the west bank of the Skeena leads 1 kilometre to the deposit. Alternatively, an old

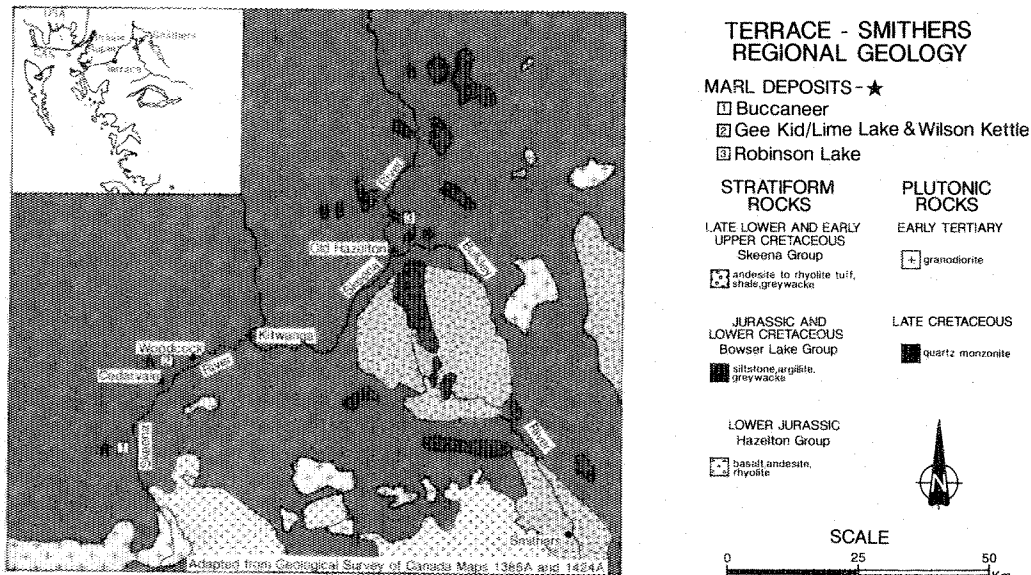

Figure 1. Geology of the Terrace-Smithers region.

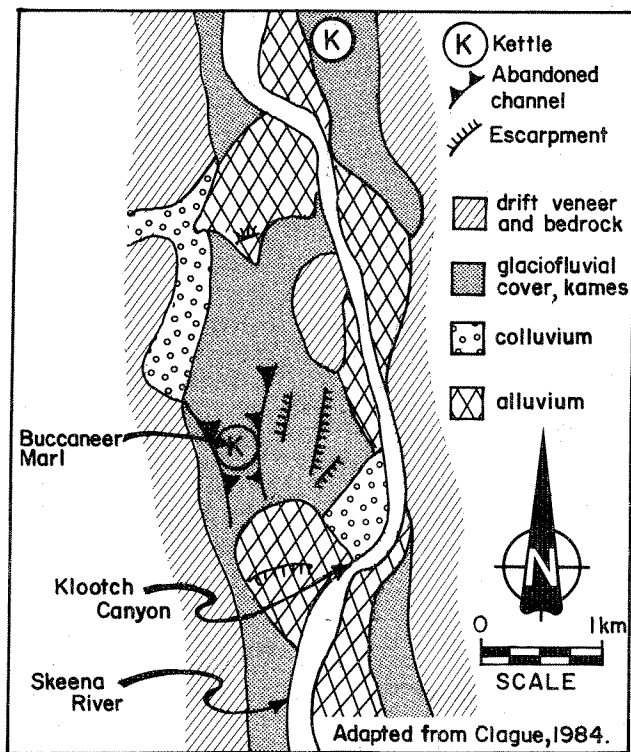

Figure 2. Surficial geology in the Buccaneer of the North area.

road can be followed southwestward from Ritchie siding.

The property was first staked in 1931 and discussed in the British Columbia Minister of Mines Annual Reports of 1931 (p. A72), 1932 (p. A90) and 1935 (p. C34). Duffel and Souther (1964) report that several railcar loads of marl were shipped to Terrace in 1935 and used for soil dressing.

TOPOGRAPHY AND SURFICIAL GEOLOGY

The marl deposit lies at an elevation of 130 metres in an ephemeral kettle lake within an abandoned channel of the Skeena River (Figure 2). To the east there is a bench 100 metres wide which gives way to kames that rise gradually 50 metres, separating the lake from the Skeena River channel (Figure 3). The glaciofluvial sedimentary cover which blankets the area consists of gravel and sand, thicker than 10 metres, deposited during the waning stages of the Fraser glaciation (Clague, 1984). Post glacial accumulations of alluvium and colluvium flank the glacial deposits on the north, east and south.

VEGETATION

Aspen and birch fringe the lake amidst a mature stand of lodgepole pine 20 to 30 metres tall. Marsh grasses and horsetails, *Equisetum* sp., fill the intermittent lake site. Nucules from the alga family Characeae have been identified (J. White, GSC, personal communication, 1989) from the marl and the algae are assumed to be present in the lake.

HYDROLOGY

The deposit lies within a depression that collects runoff locally, and from an intermittent stream, (dry at

the time of the property visit) which enters in the southwest corner (Figure 2). An earlier report (B.C. Minister of Mines Annual Report, 1935, p.C34) indicates that a stream cutting through calcareous argillites to the west of the marl disappears into the glacial debris flanking the meadow. This stream may be the dry creek mentioned above, or may be an additional source of water for the catchment basin which has no known outlet. The water supply appears to have a yearly cycle. In the fall, winter and spring, water collects and then completely evaporates or percolates away during the late spring to early fall.

SIZE

The deposit lies within a depression approximately 110 metres wide by 115 metres long. The marl underlies the depression and extends at least 70 metres beyond it to the south-southeast, beneath a gently dipping bench. The depth of the marl on the bench, in the vicinity of an old dragline cut (Figure 3), is known to be 1.5 metres for a length of 70 metres. In the 1935 report the marl is described as being 10 metres deep at the eastern end of the bench. The present owner reports that hand drilling has encountered marl to a depth of 9 metres within the depression.

Systematic sampling to define the extent of the marl within the depression and bench has not been attempted. A rough estimate in the 1935 report suggests approximately 65 000 tonnes of wet crude marl could be present in the 90 by 90 by 9 metre bench area based on the marl occupying 0.5 cubic metre per tonne. Using a linear

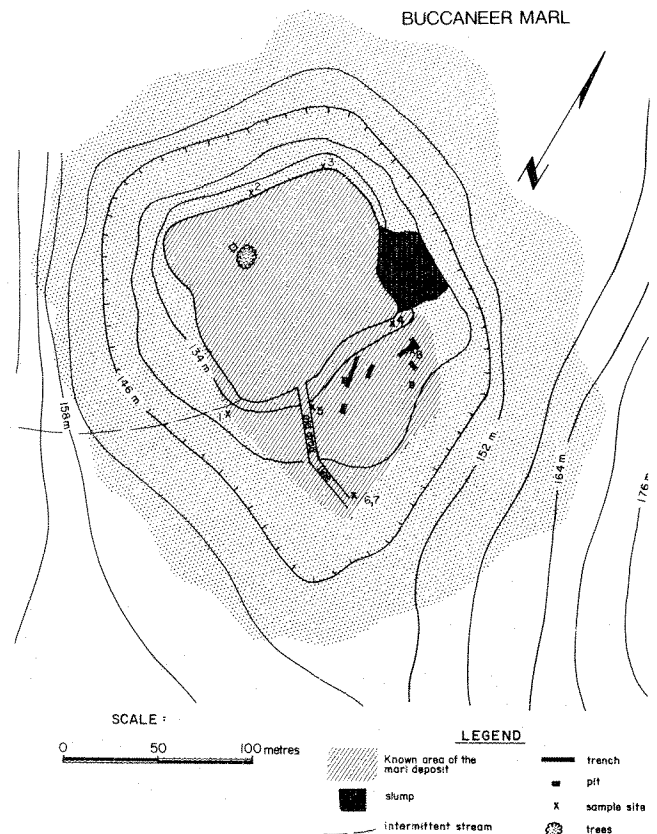

Figure 3. Topography and deposit configuration of Buccaneer of the North.

TABLE 1
CHEMICAL ANALYSES OF GRAB SAMPLES FROM THREE MARLS

Field Number	SiO ₂	TiO ₂	Al ₂ O ₃	Fe ₂ O ₃ (T)	MnO	MgO	CaO	Na ₂ O	K ₂ O	P ₂ O ₅	BaO	LOI**	SUMS	CaCO ₃ *	CO ₂	S	FeO
Buccaneer																	
1	3.33	0.03	0.61	0.31	<0.01	0.55	49.10	0.33	0.22	0.01	0.02	43.16	97.69	87.64	41.0	0.03	0.44
2	14.50	0.18	3.29	1.27	0.01	0.68	39.09	0.77	0.40	0.06	0.04	37.69	97.96	69.78	34.8	0.03	1.32
3	12.50	0.09	2.67	0.74	0.02	0.78	44.61	0.42	0.18	0.06	—	38.04	100.11	79.61	38.5	0.04	1.61
4	13.57	0.18	3.32	1.49	0.02	0.75	39.92	0.78	1.17	0.27	0.04	37.27	98.78	71.25	35.2	0.04	1.24
5	7.61	0.09	1.83	0.78	0.01	0.40	45.54	0.50	0.30	0.04	0.03	41.09	98.22	81.28	37.7	0.03	1.10
6	3.71	0.03	0.78	0.14	0.02	0.97	51.39	0.10	0.04	0.03	—	42.62	99.83	91.73	41.7	0.03	0.73
7	2.70	0.02	0.46	0.28	<0.01	0.50	49.92	0.32	0.17	0.01	0.02	42.13	96.54	89.11	40.1	0.02	0.28
8	5.60	0.07	1.33	0.61	0.01	0.40	47.47	0.43	0.25	0.02	0.03	41.58	97.79	84.73	38.8	0.02	1.06
Average	7.94	0.09	1.79	0.70	0.01	0.63	45.88	0.55	0.34	0.06	0.03	40.45	—	81.89	38.48	0.03	0.97
Wilson Kettle																	
9	8.12	0.05	1.80	0.48	0.03	0.86	42.68	0.32	0.11	0.05	—	45.34	99.84	76.18	40.6	0.38	6.05
Robinson Lake																	
10	63.95	0.85	16.40	6.98	0.06	1.71	0.99	2.22	1.41	0.02	—	5.28	99.87	1.77	1.96	0.06	4.06
11	46.37	0.63	13.79	4.71	0.07	0.99	2.34	1.52	0.90	0.18	—	28.45	99.95	4.18	29.0	0.38	—

Note: Samples 1-9 are an unconsolidated, nongritty, crumbly paste containing organics (detrital moss, root and algal fibre). Field descriptions are:

- Sample 1 - light grey, slightly moist, 10% organics
- Sample 2 - mottled light and medium green-grey, slightly moist, 10% organics
- Sample 3 - mottled light and medium green-grey, slightly moist, 10% organics
- Sample 4 - mottled light and medium green-grey, very moist, 10% organics
- Sample 5 - light grey, very slightly moist, 5% organics
- Sample 6 - white with light grey layers, dry, 15% organics
- Sample 7 - light grey, dry, 10% organics
- Sample 8 - light grey, dry, 15% organics
- Sample 9 - light grey-brown, moist paste, 20% organics
- Sample 10 - dark grey, clay rich, gritty, very moist paste
- Sample 11 - black, clay-rich, gritty, very moist paste

* all values are percentages

(T) Total Iron

** LOI values (± 2 per cent absolute) are elevated due to the high calcium carbonate content and predominantly represent volatiles such as CO₂, H₂O, F and Cl.

* Calcium Carbonate Equivalence

relationship (Figure 4) between the moisture content of crude marl and tonnes of dry marl per cubic metre, (Macdonald, 1982) an estimate can be made of the dry marl under the bench and depression. A volume of 63 250 cubic metres of marl may exist within the depression assuming dimensions are 110 by 115 by 5 metres. Assuming a moisture content varying between 30 and 50 per cent then the depression may contain between 30 000 and

41 000 tonnes of dry marl. Again assuming the same variable moisture content, 43 600 to 47 400 tonnes of dry marl may exist on the bench. The deposit may therefore contain between 64 600 and 88 400 tonnes of dry marl in total.

ANALYSIS AND COMPOSITION

Oxide analyses revealed that the samples are all marls with the total CaO content ranging from 39 to 51 per cent and averaging 45 per cent (Table 1). The CaCO₃ equivalence of these values ranges between 70 and 92 per cent with an average of 82 per cent. Small quantities of contaminants such as silica, aluminum and iron are present in quantities averaging less than 8.0, 2.0 and 0.7 per cent respectively. Other elements, as determined by spectrographic analysis, are present in amounts ranging from 0.5 percent to traces (Table 2). Dispersal of the marl in a detergent solution indicated the presence of numerous organics. Root fragments and small wood fragments, some charred, are abundant. Fragments of aquatic mosses as well as pelecypod and gastropod shells are more abundant than Characeae nucules or the more rare calcareous charophyte axes (J. White, GSC, personal communications, 1989).

GEE KID/LIME LAKE AND WILSON KETTLE MARLS

Several marl localities are situated about 1.5 kilometres northwest of the Skeena River and approximately 6 kilometres to the northeast of Cedarvale (Figure 1). One is known in the literature as the Gee Kid, or locally as Lime Lake. The second is a dry lake bed 750

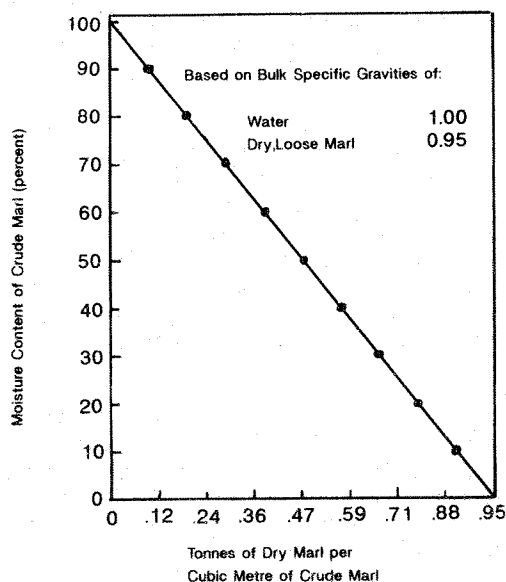

Figure 4. Estimation of dry marl available in the wet crude (from Macdonald, 1982).

TABLE 2
SPECTROGRAPHIC ANALYSES OF GRAB SAMPLES FROM THREE MARLS

Sample	Si	Al	Mg	Ca	Fe	Pb	Cu	Zn	Mn	Ag	V	Ti	Ni	Co	Na	K	W	Sr	Ba	Cr	Ga	Zr
Buccaneer																						
3	7.0	5.5	0.7	>10	1.0	—	Tr	Tr	0.1	—	—	0.06	—	—	0.5	<0.3	—	Tr	Tr	Tr	—	—
6	1.5	2.0	0.4	>10	0.4	—	Tr	Tr	0.06	—	—	0.03	—	—	0.3	<0.3	—	Tr	Tr	—	—	—
Wilson Kettle																						
9	>10	2.0	0.3	>10	0.6	—	Tr	—	0.09	Tr	—	Tr	—	—	0.3	<0.3	—	Tr	Tr	—	—	—
Robinson Lake																						
10	>10	4.0	0.6	0.25	2.7	—	Tr	—	0.1	Tr	—	0.06	—	—	1.0	<0.3	—	Tr	Tr	—	—	—
11	>10	>10	1.6	1.2	7.0	—	Tr	—	0.12	Tr	0.02	0.3	Tr	Tr	>2	>2	—	Tr	0.1	—	Tr	Tr

* all values are percentages

metres to the southwest of Gee Kid and here named the Wilson Kettle marl. Both are accessible by gravel road from Kitwanga. On the north side of Wilson Creek gravel pit travel west approximately 1 kilometre on a logging road. Taking a northeast fork at this point will lead to Lime Lake; it is about 1.2 kilometres by road then by foot 200 metres east of the end of the road. Back at the main road travel west 250 metres beyond the northeast fork and Wilson Kettle is 30 metres to the east in a flooded depression. The Gee Kid marl was staked in 1936 and discussed by Kindle (1937). The presence of marl in Wilson Kettle has not been reported previously.

TOPOGRAPHY AND SURFICIAL GEOLOGY

Gee Kid lies at 340 metres elevation with the Nass Range mountains rising to the north and west. The marl occurrence is situated 1.5 kilometres north of the Skeena River, on a 1000 by 250 metre bench blanketed with glacial drift more than a metre in thickness. Wilson Kettle is at about 325 metres elevation. Approximately 500 by 300 metres of the area is a depression, probably a kettle, in the glacial drift covering the area.

VEGETATION

The forest in the vicinity of the Gee Kid occurrence has been clear cut. Mature 30-metre lodgepole pine and spruce with some aspen surround Wilson Kettle which is flooded and has a number of dead spruce near the periphery.

HYDROLOGY AND SIZE

The Gee Kid occurrence collects local runoff in a lake measuring about 230 by 110 metres which drains into the Skeena River through an outlet creek on the southeast side. A beaver dam crossing the northeast section of the lake has raised the water level.

Wilson Kettle is oval in shape, measures approximately 170 by 100 metres with a small stream entering on the north. There is presently a beaver dam on the south which floods the depression. (It was close to dry at the time of the field visit). Since the visit, local residents reported that the small beaver dam at the southern end gave way and exposed approximately half a metre of a white to light grey marl. This indicates that the marl deposit may extend the 170 metre length of the kettle, but its depth is unknown.

SAMPLING AND ANALYSIS

With the extensive flooding, caused by the beaver dam across Lime Lake (Gee Kid), the water level has risen to such a level that sampling can only be done by boat. A boat was not available at the time of the field visit

and repeated attempts to sample the present lake shore encountered only gravel. However, the presence of a high calcium carbonate content in the water is suggested by the abundance of several species of freshwater snails along the present shoreline.

Wilson Kettle was sampled in the middle of the northeast end. At this location approximately 50 centimetres of dark brown to black, wet peat overlies a wet light grey to brown marl with abundant organics. The oxide analyses of this sample indicates a 43 per cent CaO content (or 76 per cent CaCO₃ equivalence) together with 8 per cent SiO₂ and 2 per cent Al₂O₃ contaminants (Table 1).

ROBINSON LAKE (MINFILE 93M 103)

Ten kilometres northeast of Old Hazelton a marl deposit is reported in Robinson Lake (Kindle, 1954; Figure 1). Access is by the Silver Standard/Nine Mile Mountain gravel road which begins 3.2 kilometres north of the Hagwilget Bridge. At a point 8.5 kilometres along the Silver Standard road an old logging road provides access on foot to the northeast corner of the lake, 200 metres to the north.

TOPOGRAPHY AND SURFICIAL GEOLOGY

The lake is at 470 metres elevation on the eastern margin of the Skeena River valley. Till greater than 1 metre thick blankets the area and the lake occupies a depression 630 metres long, with an average width of 120 metres.

VEGETATION

Mature 20 to 30-metre spruce surround the lake, except for the northwest section which has been clear-cut. Small patches of birch and aspen together with a stand of 30 to 40-metre hemlock and cedar border the northeast shore. Marsh grasses are abundant along the edge of the lake. As well as the grasses, Sphagnum sp. moss, Labrador tea and especially horsetails, Equisetum sp., are abundant in the wet northern portion.

HYDROLOGY

Robinson Lake collects local runoff and is drained to the southwest by Two Mile Creek from which the town of Hazelton draws its water. Beaver dams across the northeast and the southwest ends of the lake have considerably raised the water level and created an extensive marshy area to the northeast.

SIZE

Kindle (1954) reports that the shallower parts of the

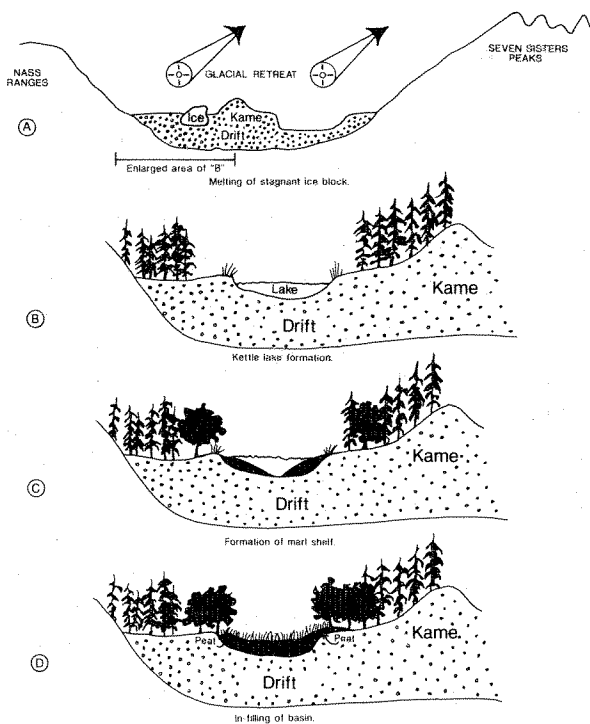

Figure 5. Development stages of a marl lake (adapted from Macdonald, 1982).

lake are bottomed by marl, particularly in the south where it was at least 4 metres deep. At present the beaver dams have raised the water level to such an extent that the dimensions of the deposit can only be determined by sampling from a boat.

SAMPLING AND ANALYSIS

Attempts to sample the marl along the southeast shoreline encountered a dark grey, clay-rich, gritty paste. Analysis shows about 1 per cent CaO with SiO₂, Al₂O₃ and Fe₂O₃ being the principal components (Table 1, Sample 10). Another sample was taken in the northeast above the beaver dam, where a number of mounds of light grey sediment dot the lake bottom. These mounds appear to be deeper sediment, possibly marl, brought to the surface by gases, noticeably rich in hydrogen sulphide. The gas is likely produced from decaying organics deeper in the sediments. Penetrating only 35 centimetres with a shovel, not enough to reach the light grey material, obtained a sample of black, slightly gritty, clay-rich paste (Table 1, Sample 11). Although CaO is present, SiO₂, Al₂O₃ and Fe₂O₃ are major constituents (Table 2).

DISCUSSION AND SUMMARY

MARL FORMATION

Marl deposits usually have four features in common: they are associated with present or past groundwater discharge areas; they are located in topographically low, poorly drained sites; they have highly permeable recharge areas nearby and they are fed by groundwater with high Ca⁺⁺ and (HCO₃)⁻ ion concentrations (Macdonald, 1982). A study by Thiel (1930) revealed that high, irregular morainal topography favours marl accumulation. He found the greatest number of large marl deposits located in coarse outwash sands and gravels.

The marl deposits in the Skeena drainage are situated in depressions on permeable glaciofluvial landforms which facilitate groundwater discharge. Adjacent areas of high relief allow rapid recharge within the water cycle and contain permeable sediments rich in calcium carbonate. A number of theories have been put forward to explain the formation of marl in lakes. Generally they fall into two broad categories: physiochemical processes such as carbon dioxide degassing and thermal stratification or biologically linked processes, such as calcium carbonate precipitation by the algal family Characeae, and by blue-green algae, or through accumulation of invertebrate remains. Duston et al (1986) concluded that calcium carbonate precipitation is probably the result of a complex interaction between these physiochemical and biological processes. Physiochemical factors certainly play a role in the formation of the deposits discussed here and biological processes also appear to be active. Characeae are known to be present and gastropods have been found associated with at least one deposit.

DEPOSIT CLASSIFICATION

Marl deposits can develop through a series of stages, as depicted in Figure 5. The Buccaneer deposit typifies the gradual in-filling of a kettle depression since the last glacial retreat approximately 10 000 years ago.

A seepage-ponded classification (Macdonald, 1982) best characterizes the Buccaneer deposit. The kettle depression collects local runoff, with the water level fluctuating according to annual precipitation and evaporation cycles. The precipitation of calcium carbonate is facilitated by the hummocky terrain with, presumably, short groundwater-flow systems. Groundwater flows occur through permeable, and reportedly calcium carbonate rich sedimentary rocks and permeable surficial sediments. In conjunction with these physical features, the presence of the alga Characeae and the physiochemical factors of thermal stratification and carbon dioxide degassing probably cause the precipitation of calcium carbonate. Grasses cover the ephemeral lake and the locality is presumably in the late stages of the development of a marl deposit. Gee Kid and Wilson Kettle marls are also best described as seepage-ponded deposits. Both sites appear to be kettle depressions which collect water and favour the deposition of marl. Precipitation of marl may be on-going in Lime Lake due to the raised water level. Wilson Kettle was only intermittently wet and covered by grasses. It is now flooded by a beaver dam and marl precipitation may continue (Figure 5).

The Robinson Lake marl may be a shoreline-fringe deposit, as classified by Macdonald (1982). Adjacent to a high relief area to the north and east, the lake collects local groundwater flow and calcium carbonate is precipitated in shallow water by thermal stratification, probably aided by the biological carbonate-fixing ability of Characeae.

SUMMARY

Of the four marl deposits studied, two, Buccaneer of the North and Wilson Kettle, contain good quality marl. The other two, Gee Kid and Robinson Lake reportedly contain marl, but are presently flooded and need further study.

The Buccaneer is estimated to contain as much as 88

400 tonnes of dry marl averaging 82 per cent calcium carbonate with a low percentage of contaminants. After removal of the thin vegetative cover, the marl could readily be scooped out and trucked to the railway only a kilometre away. The Wilson Kettle deposit contains marl of good quality with only a small percentage of contaminants, but further sampling is needed to determine its dimensions and overall quality. An all-weather road passes within a kilometre of the deposit. The extent and quality of the Gee Kid and Robinson Lake deposits was not ascertained because of extensive flooding, but exploitation of the Robinson Lake marl would be difficult as the town of Hazelton draws its water from the lake. In summary the marl in the Terrace-Hazelton area is of good quality, adjacent to transportation, readily removable, and at least one site has significant estimated reserves.

ACKNOWLEDGEMENTS

Dave Lefebure and Bob MacKillop are thanked for their assistance in the field. Dave Lefebure is especially acknowledged for his enthusiastic and constructive support throughout the project and his critical review of the manuscript. John Newell's critical comments of the original manuscript are greatly appreciated.

REFERENCES

- Clague, J.J. (1984): Quaternary Geology and Geomorphology, Smithers-Terrace-Prince Rupert Area, British Columbia; *Geological Survey of Canada*, Memoir 413, 71 pages.
- Duffell, S. and Souther, J.G. (1964): Geology of Terrace Map-Area, British Columbia; *Geological Survey of Canada*, Memoir 329, 117 pages.
- Duston, N.M., Owen, R.M., and Wilkinson, B.H. (1986): Water Chemistry and Sedimentological Observations in Littlefield Lake, Michigan: Implications for Lacustrine Marl Deposition; *Environmental Geology and Water Sciences*, 8:4, pages 229-236.
- Kindle, E.D. (1937): Mineral Resources, Usk to Cedarvale, Terrace Area Coast District, B.C.; *Geological Survey of Canada*, Memoir 212, 63 pages.
- Kindle, E.D. (1954): Mineral Resources, Hazelton and Smithers Areas, Cassiar and Coast Districts, British Columbia; *Geological Survey of Canada*, Memoir 223, 148 pages.
- Macdonald, D.E. (1982): Marl Resources of Alberta; *Alberta Research Council*, Earth Sciences Report 82-1, 94 pages.
- Thiel, G.A. (1930): A Correlation of Marl Beds with Types of Glacial Deposits; *Journal of Geology*, Vol. 38, pages 717-728.

1992 FORUM ON THE GEOLOGY OF INDUSTRIAL MINERALS, WEST VIRGINIA

By Claudette M. Simard

*West Virginia Geological & Economic Survey,
Morgantown, WV*

ABSTRACT

The 28th Forum on the Geology of Industrial Minerals, sponsored by West Virginia Geological and Economic Survey, will be held in Martinsburg, West Virginia in early May 1992. Martinsburg is located in the State's eastern panhandle, an area of the most diverse industrial mineral production in West Virginia.

The four-day meeting will be comprised of two days of technical sessions and two days of field trips. The field trips will include tours of four nearby mineral operations, unique in the State. Capitol Cement, rated at 900 000 ton capacity, quarries the folded and faulted Ordovician Chambersburg and new Market Limestones and Martinsburg Shale to produce portland and masonry cement. Nearby Continental Brick Company quarries the Martinsburg Shale to produce face brick for buildings of all types. Millville Quarry, Inc., the largest aggregate producer in West Virginia, produces over 2.5 million tons of aggregate from the high-purity Cambrian Tomstown Dolomite. The last field trip will be a tour of the U.S. Silica Company quarry and processing plant. U.S. Silica quarries, crushes and grinds the 98 per cent pure Devonian Oriskany Sandstone into silica sand, ground silica, and micron-sized silica mainly for use by the glass industry.

APPENDIX 1

ALBERTA MINERAL DEPOSITS AND OCCURRENCES / GSIS

*Wylie Hamilton, Monica Price, Dennis Chao,
Barry Fildes, Jennie Lutz
Alberta Geological Survey
Alberta Research Council
Edmonton, Alberta*

More than 30 different kinds of economic minerals are found in Alberta, mostly industrial (nonmetallic) minerals but with some notable metallics, in at least 1 500 known occurrences. Data on geologic setting and resource attributes of these mineral occurrences have been captured systematically by the Alberta Geological Survey in a computer-based file termed the Alberta Mineral Deposits and Occurrences (AMDO) file. The file provides ready access to the data using automated file searching methods. Access currently is developed in two modes, each catering to software and system capabilities of particular user segments. The first of these is HyperCard, a software package for Macintosh computers. The second is IBM-PC, standard operating tool of the minerals industry. "User friendly" elements of HyperCard have been developed on the DOS platform by use of a package called ToolBook, a software construction set for Windows.

Another means of access to Alberta minerals data is through a Geoscience Information System (GSIS) currently in development. Based on ArcInfo software, the system has online query and display capabilities that allow integration of the minerals data with other resource information, for graphic output on maps. A GSIS pilot study was completed for the Bow Valley Corridor region of Alberta, a featured site of the 1991 FGIM field trips.

The Bow Valley Corridor is a region richly developed in industrial minerals, for which an abundance of resource data exists. The pilot study has two principal products: (1) a hard-copy mineral deposits map on 1:50 000 scale, presenting the deposits in combination with various layers of geologic and geographic information; and (2) an online query and display package that displays the map on a screen with capabilities to (a) zoom in an area, (b) retrieve and display all data related to any selected deposit, and (c) allow selection by various criteria (e.g. geologic age, formation, township-range, etc). The procedures developed from this pilot are being applied on a province-wide basis to produce an operational GSIS package and Minerals Map for Alberta.

MINFILE - A MINERAL DEPOSIT INFORMATION SYSTEM

Larry Jones

*B.C. Ministry of Energy, Mines
and Petroleum Resources
Geological Survey Branch
Victoria, British Columbia*

Information on mineral deposits in a country or province is valuable to the mining industry and essential for government planning, particularly when it is easily stored, searched and distributed. The British Columbia Geological Survey Branch maintains a comprehensive mineral inventory database of over 10 500 metallic, industrial mineral and coal occurrences, known as MINFILE. This database has evolved over the past 20 years from a simple card-based file to a powerful mainframe and microcomputer-based geoscience information system. Each occurrence record contains 43 data elements which describe mineral deposits in terms of geography, geology and economics. The data elements are organized within a relational database management system and application development software, and operate micro-computer environments. The strength of the MINFILE system is its ability to efficiently and easily search, sort and manipulate data in various information fields, which include *location, tectonic belt, commodity, mineralogy, host-rock name and age, deposit type, lithology, production, and reserves*. An expanded geological description in text form is in the *capsule geology* and information sources are included in the *bibliography*.

The MINFILE database is available to a diverse and vast user-community through MINFILE/pc, a menu-driven data-entry, search and report program for the IBM/PC-compatible computer. This program is used to provide answers to specific queries, such as the relationship between mineralization and geologic features of an area, thus forming a basis for prospecting, ground acquisition and other geoscience and environmental research. MINFILE/pc helps provide solutions in mineral exploration, land-use planning and mineral resource management. Industry geologists may use MINFILE to better predict the location of new mineral deposits; land-use experts query MINFILE and channel extracted data into external support systems to make informed land-use decisions. A comprehensive mineral inventory database is an invaluable tool for academic research in metallogeny and related disciplines. MINFILE information may be used in other programs such as word processors, plotted using computer-aided mapping systems, and integrated with conventional Geographic Information Systems. MINFILE data are sold in both hard-copy and digital formats and the MINFILE system is licensed for sale worldwide for use by other geological surveys.

ALKALIC DIATREMES, CARBONATITES AND ALKALINE SYENITES IN BRITISH COLUMBIA

Jennifer Pell **

*B.C. Ministry of Energy, Mines
and Petroleum Resources
Geological Survey Branch
Victoria, British Columbia*

A previously poorly documented alkaline igneous province is present in the eastern Canadian Cordillera. It comprises carbonatites, nepheline and sodalite syenites, some ijolite series rocks, one kimberlite locality and numerous ultramafic and lamprophyric diatreme breccias, all of which intruded the Cordilleran miogeoclinal succession prior to the deformation and metamorphism associated with the Jura-Cretaceous Columbian orogeny.

CARBONATITES AND SYENITE GNEISSES

Carbonatites and syenite gneisses crop out in three belts parallel to the Rocky Mountain trench. The intrusions in the Eastern Rocky and Cassiar Mountain Belt, are Middle Paleozoic, predominantly Devonian-Mississippian in age, hosted in Lower to Middle Paleozoic strata and therefore are relatively high-level intrusions. They can be large and elliptical in shape and have significant alteration halos (for example, Aley carbonatite), simply consist of metasomatic alteration zones (for example, Rock Canyon Creek showing), or be extensive linear belts comprising numerous, and lithologically varied, sill, dykes and plugs (for example the Wicheeda Lake and Kechika River showings). The carbonatites in the Eastern Belt can be significantly enriched in niobium, fluorine, yttrium and rare earth elements.

The Central Belt lies within the Omineca Belt, immediately west of the Rocky Mountain Trench. The intrusions in this belt are also Devonian-Mississippian in age, but are hosted in Precambrian strata; they were not emplaced as high in the stratigraphic succession as those in the Eastern Belt. The carbonatites in the Omineca Mountains are thin, discontinuous, sill-like intrusions generally with fenite alteration halos. With one example, they do not tend to be as enriched in niobium, fluorine or rare earth elements as their eastern counterparts.

The Western Belt, also within the Omineca Mountains, comprises intrusive and extrusive carbonatites and nepheline syenite gneisses hosted in the autochthonous cover sequence of the Frenchman Cap gneiss dome. The extrusive carbonatites are located relatively high in the mantling gneiss stratigraphy, and are probably Eocambrian in age.

The carbonatite intrusions are sill-like bodies with extensive fenitic aureoles. Work done to date indicates moderate enrichment in rare earth elements with or without niobium.

Commercial grade nepheline syenite could potentially be produced from the Trident Mountain syenite. Other compositionally similar syenites are present in British Columbia, but are also in remote locations and remain untested.

From an economic standpoint, the Aley carbonatite has within its core extensive zones containing between two-thirds and three-quarters of a per cent niobium contents and local concentrations of over two per cent Nb₂O₅. Wicheeda Lake carbonatite complex hosts rare earth minerals and pyrochlor. Rock Canyon Creek showing contains wide-spread fluor spar with rare earth carbonates and phosphates. The complex of alkaline rocks in Kechika River area has been explored for its yttrium and rare earth potential.

KIMBERLITES, LAMPROPHYRES AND OTHER ULTRABASIC DIATREMES

Ultrabasic diatremes have been recognized in five areas of British Columbia; the Kechika River and the Ospika River areas of northern British Columbia, the Golden are of south-central British Columbia and the Bull River-Elk River and Elkford areas of southern British Columbia. In the Ospika River area, north of Mackenzie and in the Columbia Icefields area north of Golden, the diatremes are characterized by macrocryst-rich breccias and dykes.

Microdiamonds have reportedly been recovered from heavy mineral separates taken from two of the pipes in the Golden - Columbia Icefields area. Preliminary investigations suggest that these rocks are neither kimberlites nor lamproites, the two lithologies currently known to contain economic concentrations of diamonds.

***Now Geological Consultant
1356 Kingsview Road
RR5
Duncan, British Columbia
V9L 4T6*

LIMESTONE AND DOLOMITE RESOURCES IN BRITISH COLUMBIA

P. Fischl

*B.C. Ministry of Energy, Mines
and Petroleum Resources
Geological Survey Branch
Victoria, British Columbia*

Limestone and dolomite are found in abundance throughout most of British Columbia. Carbonate deposits ranging in age from Proterozoic to Jurassic can be found in all five of the tectonic belts that make up the Canadian Cordillera (Insular, Coast, Intermontane, Omineca and Foreland). The more dolomitic deposits are largely restricted to the Omineca and Foreland belts.

Purer limestone units, with generally minor contamination by chert and dolomite, are confined to extensive platformal and shelf deposits in the Upper Triassic of the insular Belt, the Permo-Carboniferous of the Intermontane Belt and the Mississippian and Upper Devonian of the Foreland Belt. Limestones associated with island arc sequences such as the Buttle Lake Group of the Insular Belt and the Nicola and Takla groups of the Intermontane Belt are commonly siliceous, argillaceous and limited in size. The Coast and Omineca belts contain limestones commonly contaminated with dolomite and various metamorphic silicates.

Extensive bedded dolomite deposits are confined to northeastern and southeastern British Columbia within Proterozoic and Paleozoic miogeosynclinal rocks of the Omineca and Foreland belts. Silt is a frequent contaminant in such deposits and chert is prevalent in some units. Smaller deposits of secondary origin occur sporadically in roof pendants of the Coast Belt, and adjacent to intrusions and faults in the Insular and Intermontane belts. Some of these deposits are contained within magnesian limestone units with sporadic dolomitization.

Limestone production in British Columbia is dominated by three major quarries on northern Texada Island, where some 4.2 million tonnes of limestone are currently mined each year. Approximately 400 000 tonnes of limestone are produced annually from six operations in the interior of the province and from one quarry on northern Vancouver island. Two Texada Island quarries produce limestone for commercial suppliers of cement and lime, while one quarry east of Kamloops supplies limestone for cement manufacturing. A second interior quarry, at Marble Canyon (Pavilion Lake), produces limestone for lime manufacturing. The two Texada Island quarries and two quarries in the interior supply chemical-grade limestone to pulp mills. White limestone is currently quarried at three sites on the coast and at one location in the interior for fillers, extenders and pigments.

White dolomite is currently produced at a rate of 40 000 tones annually from two operations in southeastern British Columbia for agricultural, decorative and pigment applications. Several other dolomite deposits have been assessed in the past as a source of magnesium metal, but there has been no production for this use.

DIMENSION STONE IN BRITISH COLUMBIA

*G. White ***

*B.C. Ministry of Energy, Mines
and Petroleum Resources
Geological Survey Branch
Victoria, British Columbia*

At the turn of the century, British Columbia produced a wide variety of quality dimension stone for both domestic and foreign markets. The industry flourished until the 1930's when many of the producing quarries closed. Our project examined formerly producing quarries to evaluate their development potential and document the stone's physical characteristics. At the same time were also documented the historical buildings where the original stone was used. White Nelson granite and Marblehead marble can be observed at the Revelstoke courthouse. Okanagan granite provided stone for the Vernon courthouse and the courtyard of the Royal British Columbia Museum in Victoria.

Granite from several coastal quarries on Nelson, Kelly, Fox and Hardy Islands has been used for construction of numerous buildings and structures in Vancouver and Victoria. Haddington Island andesite has been the most preferred stone for large buildings. Parliament Buildings, Royal British Columbia Museum and the Bank of Montreal building in Victoria are the typical examples. The maps of individual quarry sites and corresponding fracture density diagrams indicate that there is a potential for renewed granite and marble production in British Columbia.

*** Now at the Science Institute of the Northwest Territories
Inuvik Research Centre
P.O. Box 1430
Inuvik, Northwest Territories
X0E 0T0*

**MOUNT BRUSILOF MAGNESITE DEPOSIT,
SOUTHEASTERN BRITISH COLUMBIA**

*G. Simandl and K. Hancock
B.C. Ministry of Energy, Mines
and Petroleum Resources
Geological Survey Branch
Victoria, British Columbia*

For abstract see the paper in this volume.

GYPSUM OCCURRENCES IN BRITISH COLUMBIA

*S.B. Butrenchuk **
B.C. Ministry of Energy, Mines
and Petroleum Resources
Geological Survey Branch
Victoria, British Columbia*

Gypsum is a low cost, high bulk commodity that finds major usage in the manufacture of wallboard and cement and therefore is closely related to the construction and housing industry. Presently, there are two producers in British Columbia, producing in excess of 500 000 tonnes annually. Markets for this gypsum are located in Alberta and Vancouver with very minor amounts of anhydrite shipped to the United States.

At present there are sufficient reserves for 200 years based on current production rates. Westroc Industries and Domtar Industries control both the source and market for gypsum. Another source of gypsum is located at the O'Connor River deposit located in the northwestern corner of the province. This deposit could conceivably replace the imports providing lower costs and suitable contracts can be achieved. Deposits at Falkland are now nearly depleted and a deposit at Forgetmenot Creek is not likely to be developed because of its location with respect to the Willmore Wilderness Area in Alberta.

The best potential for gypsum in British Columbia is in the Stanford Range where extensive gypsum deposits of Devonian Burnais Formation can be traced from Stoddart Creek to the north end of the Top of the World Park. The resource potential for the Stanford Range between Stoddart Creek and Top of the World Park is now estimated to have a potential for 210 million tonnes. It is known that much of the area previously thought to be underlain by the Burnais Formation and therefore gypsum is underlain by carbonate strata of the Cedared Formation.

Elsewhere in the province there is a potential for 10 million tonnes at the O'Connor River deposit and 3 to 20 million tonnes at Forgetmenot Creek. Because of their locations it may be some time before these deposits are developed.

*** Now with Mountain Minerals Co. Ltd.
P.O. Box 700
Lethbridge, Alberta
T1J 3Z6*

FELDSPATHIC MINERALS IN BRITISH COLUMBIA

*G. White ** and M. MacLean
B.C. Ministry of Energy, Mines
and Petroleum Resources
Geological Survey Branch
Victoria, British Columbia*

There is currently no production of feldspathic minerals in Western Canada; British Columbia imports feldspathic sand from Idaho and nepheline syenite from Ontario.

A field study was carried out by the British Columbia Geological Survey Branch of potential and known deposits of feldspathic minerals. The sites chosen for evaluation are all in southern British Columbia and close to transportation links. Mineral processing studies were conducted by CANMET laboratories of Energy, Mines and Resources in Ottawa, Ontario.

Of the eleven prospects studied, four sites (Lumby, Hellroaring Creek, Scuzzy Creek and Trident Mountain) can produce a feldspathic product comparable to material currently being imported.

A market study of feldspathic minerals to be produced in B.C. indicates that local producers would enjoy a marked freight advantage over present suppliers.

It is estimated that about 29 700 tonnes per year of feldspar or 23 400 tonnes per year of nepheline syenite could be marketed in northwestern North America with an additional 23 400 tonnes nepheline syenite per year for Pacific Rim countries. The possibility also exists for penetration of nepheline syenite into the aplite market in Japan.

*** Now at the Science Institute of the Northwest Territories
Inuvik Research Centre
P.O. Box 1430
Inuvik, Northwest Territories
X0E 0T0*

PHOSPHATE POTENTIAL IN BRITISH COLUMBIA

*S.B. Butrenchuk **
B.C. Ministry of Energy, Mines
and Petroleum Resources
Geological Survey Branch
Victoria, British Columbia*

British Columbia is well endowed with phosphate deposits, both sedimentary and igneous. These deposits are all located in the Rocky Mountains east of the Rocky Mountain Trench. Some isolated occurrences occur west of the trench but none are of economic significance. Sedimentary phosphate occurs in a variety of forms but only pelletal varieties offer potential for future development. Grades greater than 15 per cent P_2O_5 , the threshold of economic interest, occur only in the Triassic Whistler member of the Sulphur Mountain Formation, in the Jurassic Fernie Formation and locally in Permian strata. In the future, as production in Florida decreases and mining of lower grade phosphate from the Phosphoria Formation becomes necessary, phosphate deposits in British Columbia may become economically viable.

PERMIAN

Phosphate deposits are present in several stratigraphic units of Permian age. These deposits are best developed in southeastern British Columbia, in strata of the Johnston Canyon and Ranger Canyon formations.

Two areas of pelletal phosphorite, Weigert and Nordstrum Creek appear to have limited areal extent although phosphate grades are in excess of 12 and 24 per cent respectively.

In northeastern British Columbia the best potential for Permian phosphate is in the Mowitch Formation where there is an estimated potential for 113 million tonnes with a phosphate grade averaging approximately 12 per cent P_2O_5 .

TRIASSIC

Phosphate deposits of Triassic age include predominantly nodular varieties in the Toad Formation and pelletal phosphorite in the Whistler member of the Sulphur Mountain Formation. The Toad Formation may have a resource potential in excess of 2 billion tonnes with grades of 3 to 5 per cent P_2O_5 . The Whistler member is estimated to have a resource potential of 113 million tonnes with grades of 15 to 20 per cent P_2O_5 , assuming the best possible parameters. Included in this resource is the potential for grades of approximately 64 ppm of lanthanum and 42 ppm of cerium. These deposits, because of their high carbonate content, present beneficiation problems in addition to difficult mining conditions. Although most of these deposits would have to be mined underground there appears to be some open-pit potential in the Wapiti Lake area.

JURASSIC

The best potential for an economic sedimentary

phosphate deposit occurs at the base of the Jurassic Fernie Formation. This phosphorite bed is estimated to have a maximum resource potential of 340 million tonnes grading 15 to 20 per cent P_2O_5 with approximately 195 ppm of lanthanum, 130 ppm of cerium, 480 ppm of yttrium and represents a significant source of these metals.

Beneficiation of the Fernie phosphate will require grinding to either 65- or 100-mesh depending on grain size, desliming to remove the clay fraction and flotation. Calcining will be required in areas where the carbonate or organic content is high. Exploration of these deposits should concentrate on the eastern and southeastern margin of the Fernie Basin. Phosphate grades and, to some extent, trace element contents are generally higher in these areas while the carbonate content tends to be much lower.

Carbonatites also represent a significant source of phosphate in the province. At present only the Aley carbonatite has significant phosphate potential. Other phosphate-bearing carbonatites do occur and the potential for locating more of these deposits is excellent.

*** Now with Mountain Minerals Co. Ltd.
P.O. Box 700
Lethbridge, Alberta
T1J 3Z6*

GARNET AND KYANITE IN BRITISH COLUMBIA

*Jennifer Pell ***

*B.C. Ministry of Energy, Mines
and Petroleum Resources
Geological Survey Branch
Victoria, British Columbia*

Garnet and kyanite group minerals occur mainly in two belts in the Cordillera, the Omineca crystalline belt and the Coast Mountain belt. Within these belts, pelitic metasedimentary rocks containing small percentages (less than 5 per cent) of these minerals are extremely abundant. Rocks containing significant concentrations of these minerals, however, are considerably less frequently found.

This study deals with potential hardrock sources of garnet and aluminosilicate minerals. Virtually no information exists in the literature regarding secondary placer concentrations of these minerals. Common sense, however, dictates that the general areas in which hardrock enrichment occurs should also have good potential for placer accumulations. Secondary deposits could be economic with considerably lower concentrations of desired mineral species; as little as a few per cent may be all that is necessary, as opposed to 10 to 15 per cent kyanite and 25 to 40 per cent garnet in hardrock sources. Such garnet-rich placers were recently reported by a prospector from the Revelstoke area.

Gneisses with up to 40 per cent garnet have been described from Passmore dome area (NTS 82F), schists from the Kinbasket Mountain - Sullivan River area (NTS 82N) and from Douglas Channel (NTS 103H) contain locally up to 50 per cent garnet. Garnet contents in the range from 20 to 30 per cent are common in many places of both belts of metamorphic rocks as well as concentrations of kyanite and locally sillimanite.

High concentrations of andalusite have been described from the Leech River area on Vancouver Island (NTS 92B), Prince Rupert area (NTS 103G), Nahatlatch River (NTS 92H) and Frenchman Cap dome (NTS 82M).

***Now Geological Consultant
1356 Kingsview Road
RR5
Duncan, British Columbia
V9L 4T6*

MAGNETITE IN BRITISH COLUMBIA

*K. Hancock
B.C. Ministry of Energy, Mines
and Petroleum Resources
Geological Survey Branch
Victoria, British Columbia*

Magnetite is found in several types of mineral deposits in British Columbia. The most common is skarns in which magnetite varies from the main component to a trace mineral. Other types of magnetite occurrences are usually smaller; they include differentiated magmatic, stratabound, ultramafic and placer deposits. From a production standpoint, only the skarn bodies have been mined in the past.

Historically, magnetite was produced as an iron ore with the greatest production period in the 1950's and 1960's. At present, magnetite is currently produced from a stockpile at the now closed Craigmont mine near Merritt. All of this magnetite is used in the coal processing plants of British Columbia and as the supply is limited, a new source of magnetite will be required.

Magnetite has been long overlooked as a secondary economic mineral. It is readily separated from other ores by simple methods and is easy to process. The best example is the Craigmont mine where the primary ore was chalcopyrite but now the magnetite tailings are providing continued income for the operators.

Skarn deposits provide the greatest potential source of magnetite in B.C. The west coast of Vancouver Island and the Queen Charlotte Islands, the Greenwood - Deadwood and Rossland mining camps have the largest number of recorded magnetite occurrences. As well, several iron mines closed before their ore reserves were exhausted and many copper and base metal mines discarded magnetite with the mill tailings. These are potential magnetite sources as the infrastructure is still present or readily available.

Magnetite is a subsidiary component in many mines, for example asbestos, copper and base metal mines. The tailings of these mines could be an important source of magnetite. Many mines had magnetite concentrations on the order of 10 per cent, such as the Cassiar, Granduc or Phoenix mines.

There is potential for Banded Iron Formations in B.C. One such prospect north of MacKenzie is the Falcon property.

INDUSTRIAL MINERALS POTENTIAL OF BRITISH COLUMBIA TERTIARY BASINS

P. Read

*Geotec Consultants Limited
1200 - 100 West Pender Street
Vancouver, British Columbia
V6B 1R8*

Z.D. Hora

*B.C. Ministry of Energy, Mines
and Petroleum Resources
Geological Survey Branch
Victoria, British Columbia*

This geological investigation concentrated on areas of sediment-dominated successions of Eocene age with occurrences of industrial minerals. Most of the areas lie close to major transportation routes and to nearby markets.

The Princeton and Tulameen basins share a common Eocene stratigraphy. The most extensive clinoptilolite-rich zeolite occurrences (eight showings) and the only bentonite past producer in the province (one past producer and seven showings) are in the Princeton basin.

The Merritt basin contains four widely separated, sediment-dominated sequences of the Eocene Coldwater Formation. Bentonite (two showings) is the only industrial mineral known in the basin.

Along the southern edge of the Cache Creek and Arrowstone Hills, from the village of Cache Creek to Battle Creek, tuffaceous sediments and rhyolite tephra form several sedimentary lenses up to 100 metres thick. The basal sedimentary lenses contain four heulandite-clinoptilolite showings, and where the intermediate tephra is waterlain near the base, it is bentonite-rich (two showings). In the Arrowstone Hills, the Chilcotin Group consists of up to 500 metres of olivine basalt flows of the Chasm Formation overlying up to 400 metres of rhyolite tuff and ash, and tuffaceous, fluvial and locally lacustrine sediments composing the Deadman River Formation. The sediments and rhyolite tephra fill mainly northwestward-flowing Miocene drainage channels up to 450 metres deep and 5 kilometres wide, which were mapped for over 45 kilometres from southeast of Deadman River to northwest of Bonaparte River, but probably extend much farther. Diatomite-bearing sediments are restricted to the channel fillings and intercalations among the immediately superjacent basalt flows (one producer and 23 showings).

At Hat Creek, over 1600 metres of Eocene and (?) Oligocene sediments overlie up to a few hundred metres of Eocene volcanics and as many as 400 metres of mid-Cretaceous sediments. The Eocene rocks form two northerly trending synclines and contain bentonitic horizons (one bentonite showing).

Along the Fraser River from north of Lillooet to Gang Ranch, the Fraser fault slices through Eocene and older rocks. A 200-metre-thick panel of easterly dipping

Eocene volcanic rocks and waterlain ash lies between Slok Creek and Fraser faults for at least 12 kilometres between the mouths of Fountain and Slok Creeks (one bentonite showing). A few kilometres to the north, a thin westerly dipping panel of Eocene volcanic rocks and ash underlies a 10-kilometre-long wedge east of the fault (two bentonite showings).

Most of the industrial mineral occurrences are in waterlain rhyolite (nine heulandite-clinoptilolite showings) and intermediate tephra (eight bentonite showings) in the upper part of the Eocene volcanic succession. Volcanic glass (three showings) and perlite (two showings and one past producer) form in rhyolite flows and hypabyssal intrusions.

The geological setting of the previously known occurrences, combined with the known or inferred chemical and physical conditions of the 63 occurrences discovered during this study, lead to the following conclusions:

Of the areas investigated, industrial zeolite occurrences are restricted to the Princeton and Tulameen basins, basal sedimentary lenses near McAbee, and waterlain rhyolite tephra along the Fraser River. In the Princeton basin, zeolitized tephra horizons are up to 3.5 kilometres long and 30 metres thick. Some samples have cation exchange capacities (CEC) similar to those of the products from operating deposits in the western United States. Along the Fraser River, a few intermediate CEC values suggest an industrial zeolite potential.

Bentonite is widespread in sedimentary and adjacent volcanic rocks of Eocene age. Although few of the areas have been explored, drilling at Hat Creek has outlined significant thicknesses. From a few exchangeable cation analyses, divalent cations dominate except for showings in the south end of the Princeton basin and a showing in the Deadman River valley.

Known kaolinite occurrences in British Columbia are the result of subtropical weathering of gra-

nitic or compositionally equivalent volcanic rocks on unconformities ranging in age from Early Cretaceous to Late Eocene. Kaolinite occurrences are in sediments overlying such an unconformity developed on granitic rocks, but sediments are absent within the area investigated. They occur to the southwest in the Georgia Basin and may have developed to the northwest in the Chilcotin-Nechako region.

Perlite develops in glassy rhyolite which is part of the little-altered Eocene volcanic sequence along the Fraser River. Similar rocks may occur farther north along and west of the river.

Diatomaceous earth occurs in Miocene and younger rocks in the sedimentary fill of the deep drainage channels buried beneath the widespread basalt flows of the Chilcotin Group. All of the showings in Arrowstone Hills are in the sediments of this northwestward-flowing drainage system, and those north of Gang Ranch are in sediments in a north-draining channel. This Miocene drainage system subparallels the Fraser and undoubtedly has tributaries to the west, in the Chilcotin-Nechako area.

Although not a subject of this investigation, the discovery of a major northwesterly to northerly flowing Miocene drainage system opens the possibility of Miocene placer gold and provides a framework to guide the prospecting for such occurrences.

OLIVINE POTENTIAL IN BRITISH COLUMBIA

*G. White ** Z.D. Hora
B.C. Ministry of Energy, Mines
and Petroleum Resources
Geological Survey Branch
Victoria, British Columbia*

The dunite core of the Tulameen ultramafic complex is composed of variably serpentized olivine. Detailed sampling has identified three zones of fresh unaltered olivine located on Grasshopper Mountain near the confluence of Britton Creek and Tulameen River. The zones exhibit loss of ignition less than 2 per cent.

Olivine samples from the fresh rock were tested for suitability in foundry sand applications. After positive results on a laboratory scale, a full series of tests with five separate metal castings were made. In each trial the Grasshopper Mountain olivine sand performed equally as well as the standard product available on the market. The olivine from the Tulameen complex compares favourably with other deposits worldwide and represents a development opportunity.

*** Now with the Science Institute of the Northwest Territories
Inuvik Research Centre
P.O. Box 1430
Inuvik, Northwest Territories
X0E 0T0*

THE PEAT RESOURCE IN BRITISH COLUMBIA

*D.E. Maynard, Consultant
13-251 West 14th Street
North Vancouver, British Columbia
V7M 1P4*

It is estimated that approximately 1 per cent of the total land area of British Columbia is covered by peatland, much of which occurs in remote areas.

The dominant peatlands of British Columbia are mainly classed as bogs or fens. Bogs are ombrotrophic peatlands with high water tables. The surface of bogs is virtually unaffected by nutrient-rich groundwater from surrounding mineral soils and thus is usually acidic and low in nutrients. Dominant materials are poorly to moderately decomposed sphagnum moss and woody peat, underlain at times by sedge peat. Fens are meadow-like, minerotrophic peatlands with high water tables. They are richer in nutrients and less acidic than bogs. Dominant materials are moderately to well-decomposed sedge or brown moss-peat of variable thickness.

Three general regions of the province are identified by the peatland inventory as being the principal locations of the resource: central and north coast area, central Interior Plateau and northeastern Great Plains. The largest deposits occur in the northeast. Large peat deposits also occur on certain coastal lowlands. Interior peatlands are usually smaller, but occur in clusters.

Peatlands are a common landform north of 50 latitude along a coastal strip 30 to 100 kilometres wide. The large peat deposits consist mainly of flat and slope bogs located on the Queen Charlotte Lowland, on the flat, mid-coast islands, in the Nootka Sound area and near Prince Rupert. They usually have a thin surficial cover of sphagnum moss overlying well-humified, sedge-dominated peat. On Vancouver Island and the adjacent mainland coast, peatlands are mainly undifferentiated organics and fens which are usually small in area and isolated from one another. Sedge-dominated peats are common in these areas.

Peatlands of the Interior Plateau are mainly fens, other sedge or brown moss-dominated organics and undifferentiated organics. Sphagnum bogs are uncommon. The north-trending core of the plateau, west of the Fraser River between Williams Lake and Prince George, has the highest concentration of organics.

Peat deposits occupy extensive tracts of level or depressional ground in the Peace River and Fort Nelson lowlands. Fairly deep sphagnum bogs predominate in these regions but fens are also common south of the Peace River. Bogs in the Fort Nelson area consist of an upper layer of partially decomposed fibric mosses overlying moss, sedge and woody peat of more advanced decomposition. Permafrost within 1 metre of the ground surface is a common feature of these extensive bogs. The Fort St. John - Dawson Creek area features clusters of contiguous and isolated bogs and fens in the south. Further north, vast level areas are nearly continuous bogs and bog-fen complexes. The bogs are similar to those in the Fort Nelson area but are unlikely to contain perennially frozen layers.

WOLLASTONITE IN BRITISH COLUMBIA

P. Fischl

*B.C. Ministry of Energy, Mines
and Petroleum Resources
Geological Survey Branch
Victoria, British Columbia*

Wollastonite, a calcium silicate pyroxenoid used in ceramics, paints, plastics and in asbestos replacements, is known to occur at several sites in British Columbia as a major component of skarn bodies of contact metamorphic and metasomatic origin. There is potential for wollastonite to occur in significant quantities in carbonatite deposits, although it has yet to be identified in the numerous carbonatites that are known within the province.

Tremolite, an amphibole of similar origin and with the potential for similar uses as wollastonite, is found in similar geologic environments throughout the province.

Mapping, sampling and a review of the MINFILE database has identified seven skarn occurrences containing significant wollastonite and two with significant tremolite. Of these occurrences, only Snake Bay is in the advanced exploration stage with drill-indicated reserves.

Testing by CANMET of bulk samples from four of the wollastonite occurrences and one tremolite occurrence revealed that wollastonite and tremolite with only low to moderate aspect ratios could be produced using conventional grinding and beneficiation techniques. Of the five deposits tested, marketable wollastonite-tremolite concentrates (less than 1 per cent Fe_2O_3 and ignition loss) could be produced from three of the occurrences with wet, high-intensity magnetic separation and reverse anionic flotation.

PERLITE AND VERMICULITE IN BRITISH COLUMBIA

*G. White ***

*B.C. Ministry of Energy, Mines
and Petroleum Resources
Geological Survey Branch
Victoria, British Columbia*

Perlite deposits in British Columbia selected on the basis of their accessibility to established transportation networks were assessed for their development potential. As a benchmark was used the Frenier deposit near Empire Valley in central British Columbia, which saw production from 1985 through 1985 and has a proven record of high quality expanded product. The deposits were mapped and sampled to correlate their expansion properties. The results indicate, that perlites from Frenier deposit, Uncha Lake, Francois Lake and Ootsa Lake in B.C. interior and Blackwater Creek on Queen Charlotte Islands have similar expansion rates between 258 and 450 kilograms per cubic metre. The Gold Creek sample from Queen Charlotte Islands, however, expanded significantly more reaching a bulk density of 166 kilograms per cubic metre. The Gold Creek site location is particularly attractive because of its location near tidewater in the Port Clements area.

Jurassic intrusives in the Fort St. James - Fraser Lake area contain mica flakes which swell when heated with a propane torch. While the laboratory testing did not produce vermiculite with bulk densities meeting ASTM specifications for loose insulation, there is still a potential in filler or aggregate uses for this resource.

*** Now with the Science Institute of the Northwest Territories
Inuvik Research Centre
P.O. Box 1430
Inuvik, Northwest Territories
X0E 0T0*

TALC INVENTORY OF BRITISH COLUMBIA

M. MacLean

*B.C. Ministry of Energy, Mines
and Petroleum Resources
Geological Survey Branch
Victoria, British Columbia*

The geology of British Columbia offers potential for the discovery of a quality talc deposit. Generally, the highest purity talc is derived from deposits associated with magnesium carbonate rocks, and the talcs of lesser purity come from altered ultrabasic igneous rocks. Two properties studied by the industry in recent years have identified talc meeting the pulp and paper industry standards.

At the present time there are no operating talc mines in British Columbia; all of the province's talc is imported.

In British Columbia the greatest demand for talc comes from the pulp and paper industry where it is used for pitch control, and as a filler for paper coating. The twenty-five pulp mills in the province and five mills in Alberta use as much as 2.3 tonnes of talc per day. Tens of thousands of tonnes of talc are required by the industry each year.

There are many ultramafic belts in British Columbia which are ideal settings for a higher purity talc deposit. Other favourable host rocks which warrant exploration are also documented.

The number of known talc occurrences, together with favourable geology and laboratory research, indicates that talc meeting the industry's standards can be produced in British Columbia.

Of the four British Columbia pyrophyllite showings, the largest, at Kyoqout Sound, is hosted in dacitic to andesitic volcanics, with abundant associated alunite.

CHROMITE IN BRITISH COLUMBIA

*K. Hancock
B.C. Ministry of Energy, Mines
and Petroleum Resources
Geological Survey Branch
Victoria, British Columbia*

This poster records the most significant mafic-ultramafic-associated chromite occurrences in British Columbia.

Exploration for chromite in British Columbia has not been extensive. It was primarily done in the early 1930's through to the late 1940's. The primary targets in exploration for chromite mineralization are the mantle portions of ophiolite bodies and ultramafic intrusions. Regionally, the most significant settings for ultramafic rocks are the Cache Creek terrane, the Anarchist Group rocks and their equivalents, the Shulaps ultramafic complex and the Hozameen Groups as well as the Alaskan-type mafic-ultramafic intrusions.

Ophiolite complexes comprise a sequence of metamorphic to plutonic though hypabyssal volcanic and extrusive to sedimentary rocks. In British Columbia there are several ultramafic complexes which are the ultramafic, plutonic or upper mantle sections of a typical ophiolite sequence. These include the Shulaps ultramafic complex, ultramafic sections of the eastern facies in the Cache Creek terrane, and the Blue River ultramafite. Many of these bodies host minor chromite mineralization.

Alaskan-type ultramafic-mafic complexes occur in orogenic belts and are believed to have formed in subvolcanic magma chambers in volcanic arcs over subduction zones. These complexes are intrusive and may be crudely zoned from ultramafic lithologies in the 'core' to gabbroic rocks near their margin.

Each complex may not contain a full suite of rock types which may make recognition of an Alaskan-type body difficult. In B.C. the Polaris and Tulameen complexes contain all of the typical rock types but others, such as the intrusions at Johanson Lake and Menard Creek, only have some of the characteristic lithologies.

Alaskan-type complexes in British Columbia fall into two discrete groups based on age and tectonic setting. Several complexes in Alaska have been dated at 100 Ma by potassium-argon methods, some complexes in British Columbia have been dated between 175 Ma and 156 Ma by potassium-argon methods.

Alaskan-type complexes may show prominent contact aureoles, usually of amphibolite grade, but they are commonly fault-bonded. The intrusions are usually small in size, a few kilometres across but may reach 20 kilometres in length (e.g. Tulameen). Faulting of the complexes can significantly distort their original shape and orientation.

FLUORSPAR AND FLUORINE IN BRITISH COLUMBIA

*Jennifer Pell ***

*B.C. Ministry of Energy, Mines
and Petroleum Resources
Geological Survey Branch
Victoria, British Columbia*

Fluorspar mineralization in British Columbia occurs in a wide range of geologic environments and tectonic settings. Fluids (volatiles) are always important in the mineralizing process. Where fluorspar is associated with igneous systems, the late-stage differentiated fluids that were fractionated during crystallization are often enriched in incompatible elements (be it in granitic or alkaline systems) and play an important role.

Five significant fluorspar prospects are known in British Columbia. The Rock Candy mine, a vein deposit of probable late Tertiary age associated with the Coryell intrusions, occurs in the southern Omineca Belt and has a history of past production. The Eaglet fluorspar property consists of veins and replacements, of possible Cretaceous age, in the Quesnel Lake gneiss at the western margin of the Omineca Belt in central British Columbia. The Rexspar deposit, which is located along the western margin of the Omineca Belt in south-central British Columbia, comprises separate zones of fluorspar and uranium mineralization of volcanogenic origin, related to alkaline tuffs. Mineralization at Rexspar is considered to be syngenetic and Devonian-Mississippian in age. The Deep Purple prospect on Rock Canyon Creek, in the Foreland Belt of southern British Columbia, is a metasomatic replacement deposit interpreted to be related to carbonatite-alkaline rock system. Mineralization at Deep Purple is probably Devonian-Mississippian to Early Mississippian in age. The Foreland Belt of northern British Columbia contains the carbonate-hosted Liard fluorspar showings which are apparently related to carbonate-hosted lead-zinc deposits further to the south and formed by dewatering of the sedimentary basin in the Late Devonian.

A number of showings containing abundant fluorspar are also known. The Redbird property, located in the eastern Intermontane Belt, contains veins of epithermal fluorite and chalcedonic quartz hosted by Triassic Nicola Group volcanics. The Gypo (Oliver Silica) quarry near Oliver, the Whiteman Creek property near Vernon and the Galena Farm property near Silverton are all examples of quartz-fluorite and quartz-fluorite-lead-zinc-silver veins associated with Jurassic or Cretaceous granites and quartz monzonites in the Omineca Belt.

Numerous other showings occur throughout the province, but the major deposits and significant showings are confined to the Foreland and Omineca belts and eastern portions of the Intermontane Belt, which suggests that these areas are most favourable for future exploration. Some deposits with abundant fluorspar are reported from the Atlin area in the northern Intermontane Belt; this area also warrants exploration attention. The majority of fluorite deposits in British Columbia are underlain by crust with Mesozoic or Cenozoic $\text{Sr}^{87} / \text{Sr}^{86}$ initial ratios of greater than 0.704. Areas with ratios of 0.707 or greater are underlain by Precambrian crust that has been incorporated into younger magmas; initial ratios of between 0.704 and 0.707 are indicative of areas underlain by reworked Precambrian basement of Proterozoic, continent-derived sediments. Initial ratios of less than 0.704 are indicative of areas underlain by ensimatic Phanerozoic crust (Armstrong, 1985). The fluorite deposits are formed, preferentially in areas underlain by continental (sialic) basement or continent-derived basement rocks. Areas with $\text{Sr}^{87} / \text{Sr}^{86}$ initial ratios of less than 0.704 are unlikely to host fluorspar deposits and, as such, are not favourable exploration targets.

***Now Geological Consultant
1356 Kingsview Road
RR5
Duncan, British Columbia
V9L 4T6*

INDUSTRIAL MINERAL DEVELOPMENTS IN NEWFOUNDLAND AND LABRADOR

*Jamie Meyer and Ambrose Howse
Geological Survey Branch
Newfoundland Department of Mines and Energy
95 Bonaventure Avenue
P.O. Box 8700
St. John's, Newfoundland A1B 4J6*

The 1990's hold great promise for the ongoing production of industrial minerals in Newfoundland and Labrador, and the development of new and exciting deposits. Several of the more promising developments are now briefly discussed.

The lower Paleozoic carbonate sequences of western Newfoundland host important deposits of limestone, marble and dolomite. The newly developed high-volume limestone aggregate quarry at Lower Cove on the Port au Port peninsula (Newfoundland Resources and Mining), is the largest current producer. Smaller tonnages are quarried for agricultural limestone and cement manufacturing. There is increased interest in the extremely pure limestone reserves within this belt, particularly for use in pollution control systems.

In western Labrador there are a number of large, extremely pure quartzite ridges near Labrador City, representing immense reserves of high quality silica. One of these ridges was drilled in 1986. In the same area, there is a unique deposit of very high purity, friable quartzite. This deposit was drilled, and is estimated to contain a minimum of 4 million tonnes silica sand. Initial beneficiation studies have reduced impurity levels to 0.01% Al_2O_3 and 0.01% Fe_2O_3 .

Exploration for graphite in western Labrador by the Department of Mines and Energy, located a significant graphite prospect in 1989. A 25 kilogram sample, obtained from a 15 metre long trench, contains 41.9% carbon, although all flakes are finer than 300 micrometres. The deposit was staked by local prospectors in Labrador City, and carried out a small exploration program in 1990.

An investigation of the heavy-mineral placer potential of the Lake Melville area in Labrador, was begun in 1989 by the Department of Mines and Energy, and continued in 1990 with help from the placer section of the Centre for Coal Ocean Resources and Engineering (C-CORE). The numerous rivers entering Lake Melville and the coastal zone between Groswater Bay and Sandwich Bay, drain hinterlands underlain by gabbro-anorthosite massifs containing disseminated ilmenite. A 20 kilometre long coastal beach system had the highest concentration of heavy minerals seen during the sampling program, up to 50% over 1 metre in thickness.

The dimension stone potential of Newfoundland and Labrador has been highlighted in recent years through demonstration projects, and exploration by government and industry. The most advanced project was carried out in 1990 by the Mt. Peyton Granite Company. They

quarried 3 to 7 tonne rough blocks of "black granite" from the Mt. Peyton gabbro in Central Newfoundland, and 6 to 15 tonne blocks of pink granite from the Pass Island granite on the South Coast. Many other granite prospects are being investigated. A large marble prospect in the Deer Lake area contains many different colours and textures of stone and could potentially host several quarries. In 1986 the Department of Mines and Energy carried out sampling of three dimension stone prospects in the Nain anorthosite, on the northern Labrador coast. A productive visit to the area by an Italian quarrying company in 1990 may lead to the formation of a joint venture company with the Labrador Inuit Development Corporation. Test blocks were quarried in the fall of 1990, and shipped to Italy.

Eastern Newfoundland possesses several deposits of excellent quality slate located at tidewater, some of these were worked in the late 1800's. An old slate quarry at Nut Cove, Trinity Bay, was reactivated in 1986 but large scale production has yet to be achieved. Welsh and American slate experts who have visited slate prospects in the province have agreed that the green and purple slate is of top quality, and that there is potential for red and grey slate as well.

BARITE IN BRITISH COLUMBIA

*S.B. Butrenchuk ***

*B.C. Ministry of Energy, Mines
and Petroleum Resources
Geological Survey Branch
Victoria, British Columbia*

Commercial production of barite in British Columbia dates back to 1940 with shipments having been recorded from 10 deposits. Presently, barite in significant amounts is only produced from a single underground mine at Parson by Mountain Minerals Company, Ltd. There is some intermittent production from three other deposits.

Barite (BaSO_4) is a chemically inert mineral with an ideal specific gravity of 4.5 whose major usage is as a weighting agent for drill muds. Therefore, major markets are closely associated to the oil and gas industry. Potential market areas are oil and gas exploration wells in the Arctic Islands, Western Canada Sedimentary Basin and British Columbia offshore with the first being the largest potential market.

Potential new large sources of barite are located in shale and carbonate hosted bedded deposits in northeastern British Columbia. Stratigraphically these deposits occur in rocks of Devonian to Lower Mississippian age. Deposits like Cirque when developed for silver/lead/zinc production will have abundant barite as a by-product. In southeastern British Columbia vein and replacement type deposits present in rocks of Proterozoic and Lower Paleozoic age represent another potential source of barite. By-product barite may also be recovered from the mining and milling of volcanogenic massive sulphide deposits. The vein and replacement barite has usually higher purity and brightness and may be therefore more suitable for higher value barite products in filler/extender applications.

*** Now with Mountain Minerals Co. Ltd.
P.O. Box 700
Lethbridge, Alberta
T1J 3Z6*

MANITOBA INDUSTRIAL MINERALS

*Jim Bamburak
Manitoba Energy and Mines
555 - 330 Graham Avenue
Winnipeg, Manitoba
R3C 4E3*

The poster consists of seven elements: a 1:1 000 000 location map of Industrial Mineral Producers and six selected commodity descriptions (text, map and photo). Total value of production in 1989 of silica sand, dimension stone, peat, high-calcium limestone and gypsum accounted for \$24 million.

Traction sand, foundry sand, sandblast sand and construction products are produced from Ordovician silica sand; silicon metal may be a future product.

Dimension stone from three Precambrian quarries and one Ordovician quarry have been utilized in buildings in Canada and United States.

Almost 90 per cent of horticultural sphagnum from southeastern Manitoba bogs is shipped to the United States.

Cement and chemical grade lime is produced from high-calcium limestone quarries in Devonian-age formations.

Wallboard is produced from Jurassic-age sediments located on the west side of Lake Manitoba.

High-magnesium dolomite, with more than 19 per cent MgO, is not in production, but has a wide areal extent in the Interlake area.

WESTERN INDUSTRIAL CLAY PRODUCTS LTD.

*Peter Ayles
714 East Sarcee Street
Kamloops, British Columbia
V2H 1E7*

Western Industrial Clay Products Ltd., in Kamloops, B.C., was chosen as the recipient for the 1990 Federal Business Development Bank's award in the Product Enhancement category.

Western Industrial Clay Products Ltd. is the only Canadian company who is locally mining, milling, and packaging diatomaceous earth for industrial absorbent applications. Their Can-Dry industrial absorbent is one of the highest quality products available on the market today.

Recently, Western Industrial Clay Products Ltd. introduced a new product, W.C. Cat, a new Canadian cat litter. Although a relatively recent arrival on the market, W.C. Cat is already enjoying a positive consumer response and is rapidly winning customer acceptance throughout Western Canada. Because of its inherent composition of diatoms and clay, W.C. Cat is able to effectively absorb odours without any chemical or deodorant additives, unlike other brands of cat litter. And because of this naturally occurring combination of elements, W.C. Cat is also able to absorb its own weight in water which means less litter is wasted.

Western Industrial Clay Products Ltd. has good reason to be proud of their achievements, not only because they have created a product literally from the earth, but because their products are also completely natural, and best of all, always environmentally friendly.

DIMENSION STONE AERIAL PHOTOGRAPH STUDY

*Jay Page
Westex Exploration Ltd.
Vancouver, British Columbia*

An aerial photograph study was proposed as a cost effective means of providing a public database to promote the exploration for and development of new dimension stone quarries. Many essential features of successful quarries are visible on aerial photographs, and these areas can be located for a fraction of the cost of ground searches. In October, 1990 Westex Exploration Ltd. was contracted by the Ministry of Energy, Mines and Petroleum Resources to carry out an aerial photograph study of selected intrusions in southwestern British Columbia.

The aerial photograph study focused on granite intrusions of the types identified as having market potential in the 1989 Geological Survey Branch publication British Columbia Dimension Stone Market Study. The initial area considered for the study was the Southern Coast Range, and within this area all granodiorite and gabbro intrusions were examined. Quartz diorite intrusions in the Squamish and Duffy Lake road areas were also included in the study.

The technique of using aerial photograph to locate potential quarry sites integrates information from a variety of sources, of which the photographs are primarily used to locate areas of solid rock. Other information such as geology, access, elevation, etc. is obtained from geological, topographic and land-use maps. The basic assumption when using this technique is that areas of solid rock with moderate topography and reasonable access are potential quarry sites. The study was carried out in two phases; the first phase was a regional study using intermediate scale (1:31 680 to 1:40 000) photographs to locate areas of solid rock. This was then followed by a detailed study of each area using larger scale (1:15 000) photographs.

The aerial photograph study successfully identified a number of potential granite dimension stone quarry sites. A total of 725 stereo pairs of photographs were examined in the regional photograph study, and 165 sites were chosen for detailed study. The detailed study identified 30 sites as economically interesting, which were then rated according to a set of evaluation criteria.

THE AGGREGATE MARKET OF THE EASTERN UNITED STATES

*Richard Poulin
University of British Columbia
Dept. of Mining and Mineral Process Engineering
Vancouver, British Columbia*

The aggregate market of the Eastern United States is quantitatively modelled and the interaction of its components measured. Concrete and paving aggregate were the selected types for the purposes of this study. Using 1987 as base year, production is segmented into geographic units by using information obtained from the Mine Safety and Health Administration. The quarry price is given by an empirical relation, accounting for urbanization, and based on an extensive telephone survey. The global demand is determined by econometric procedures. The break-down by geographic unit is performed using construction data in an input/output manner. Transport, which is multi-modal, is simulated by linear programming. These concepts are consolidated by the optimisation of aggregate distribution. The model developed is used to simulate different situations, demonstrating the reliability of the obtained solutions.

IMASCO INDUSTRIAL MINERALS

*D. Gunning, President
International Marble & Stone Co. Ltd.
Surrey, British Columbia*

For abstract see the paper in this volume.

THE ORTHOSHOP

John Kende

The Orthoshop - Calgary

A Division of McMurchy Warne Surveys (Alberta) Ltd.

Calgary, Alberta

The Orthoshop provides surveying, mapping and consulting services to the mining, petroleum, resource, development industries and environmental studies worldwide.

The Orthoshop employs Survey and Photogrammetric Engineers, Professional Photogrammetrists, Cartographers, Computer Programmers and Photographic Technicians.

The Orthoshop is at the forefront of automated photogrammetric companies. Utilizing 3 million dollars worth of photogrammetric equipment and a large library of software, the Company produces both digital and orthophoto maps.

The company uses the Digital Elevation Modelling (D.E.M.) method exclusively for digital map production. This necessitates obtaining 3 dimensional coordinates for gridding and break lines. For most of the projects the client is given the raw data tape for their in-house use. Digital mapping is cost effective, accurate and useful in future digital manipulation. The raw data can be used for volumetric computation, cross-section plots and for various engineering studies.

The Orthoshop has the most up to date software and hardware to produce orthophotos. Orthophoto is a most informative product, it is used in exploration, planning, environmental studies, or for presentation. It is produced quickly and economically.

The Orthoshop operates a CADD system to ensure the final product meets the highest possible standard.

APPENDIX 2

Registrants
27th Forum On The Geology Of Industrial Minerals
Banff, Alberta, May 5 to May 10, 1991

- Abel, John C.**, Kerford Limestone Co., P.O. Box 81201, Lincoln, NE 68501, USA. (402)-476-0129. Fax: (402)-476-3310.
- Arenberg, Eric**, Dupont, Rt 2 Box 2688, Melrose, FL 32666, USA. (904)-475-5057
- Austin, George S.**, New Mexico Bureau of Mines & Min. Res., Campus Station, Socorro, NM 87801, USA. (505)-835-5230. Fax: (505)-835-6333
- Bamburak, James D.**, Manitoba Energy and Mines, 555 - 330 Graham Avenue, Winnipeg, Manitoba R2Y 1A9, Canada. (204)-945-6534. Fax: (204)-945-0586.
- Barker, James M.**, New Mexico Bureau of Mines & Min. Res., Campus Station, Socorro, NM 87801, USA. (505)-835-5114. Fax: (505)-835-6333
- Barsotti, Aldo**, U.S. Bureau of Mines Minerals Availability Field Office, Building 20, Denver Federal Center, Denver, CO 80225, USA. (303)-236-5210. Fax: (303)-236-4208.
- Bartlett, Stanley C.**, Canada Tungsten Mining Corp. Ltd., 1600 - 1066 W. Hastings St., Vancouver, B.C. V6E 3X1, Canada. (604)-689-0046. Fax: (604)-688-8370
- Bates, Robert L.**, 180 Canyon Drive, Columbus, OH 43214, USA. (614)-268-4989
- Bebensee, Lloyd**, Skaha Petroleum Ltd., 317 Weldwood Dr. SW, Calgary, Alberta T3C 3E4, Canada. (403)-264-6836. Fax: (403)-264-6838.
- Benkis, Ronald A.**, Monenco Consultants Limited, 400 Monenco Consultants Limited, 801 - 6th Ave. SW, Calgary, Alberta T2P 3W3, Canada. (403)-298-4195. Fax: (403)-298-4125
- Bentzen, Edwin H.**, Hazen Research Inc., 4601 Indiana Street, Golden, CO 80403, USA. (303)-279-4501. Fax: (303)-278-1528.
- Berg, Dick**, Montana Bureau of Mines and Geology, Butte, MT 59701, USA. (406)-496-4172. Fax: (406)-496-4133.
- Bergeron, Michel**, Energy, Mines & Resources, 460 O'Connor Street, Ottawa, Ontario K1A 0E4, Canada. (613)-992-5474. Fax: (613)-992-5893.
- Blender, Doug**, Domtar Gypsum, 12509 - 116 Ave., Surrey, B.C. V3V 3S6, Canada. (604)-580-0638. Fax: (604)-580-1073.
- Boisvert, Doug**, Alberta Geological Survey, Box 8330 Station F, Edmonton T6H 5X2, Canada. (403)-438-7638. Fax: (403)-438-3364.
- Bond, James E.**, Lafarge Canada Inc., 6150 Royalmount Ave., Montreal, Quebec H4P 2R3, Canada. (514)-738-1202. Fax: (514)-738-1124.
- Bond, Martha**, Consulting Geologist, 2715 Keller Boulevard, Saint-Laurent, Quebec H4K 1L8, Canada. (514)-956-0677.
- Bourne, H.L.**, Consulting Geologist, P.O. Box 293, Northville, MI 48167, USA. (313)-462-0005. Fax: (same)
- Burgh, Ernest E.**, EEB Inc., 55 Terry Ct., Chicago Heights, IL 60411, USA. (708)-754-8466.
- Butrenchuk, Stephen B.**, Mountain Minerals Co. Ltd., P.O. Box 700, Lethbridge, Alberta T1J 3Z6, Canada. (403)-329-0443. Fax: (403)-328-9110.
- Campbell, Dr. John D.**, Jaycon Reconnaissance, 10908 - 65A Street, Edmonton, Alberta T6A 2P7, Canada. (403)-466-0109. Fax: (403)-469-0930.
- Cardinal, Dan**, Highland Talc Minerals Ltd., P.O. Box 594, Hope, B.C. V0X 1L0, Canada. (604)-869-9825. Fax: 9604)-869-9408.
- Century, Jack**, Industrial Minerals Recovery Inc., 1170, 340 12th Ave SW, Calgary, Alberta T2R 1L5, Canada. (403)-262-2835. Fax: (403)-262-2835.
- Chao, Dennis**, Alberta Geological Survey, P.O. Box 8330 Station F, Edmonton, Alberta T6H 5X2, Canada. (403)-438-7637. Fax: (403)-438-3364.
- Chapman, John A.**, J.A. Chapman Mining Services, #30 1725 Southmere Cr., Surrey, B.C. V4A 7A7, Canada. (604)-682-4700. Fax: (604)-682-0606.
- Clardy, Benjamin F.**, Arkansas Geological Commission, 3815 West Roosevelt Road, Little Rock, AR 72204, USA. (501)-324-9165.
- Clement, Stephen C.**, Dept. of Geology, College of William and Mary, Williamsburg, VA 23185, USA. (804)-221-2442. Fax: (804)-221-3540.
- Coats, Ken**, American Aggregates Corp., 6450 Sand Lake Road, Dayton, OH 45414, USA. (513)-454-1128. Fax: (513)-454-2900.
- Cochrane, Kathryn J.**, Alberta Energy (Research and Technology Branch), 11 th Floor, 9945 - 108 St., Edmonton, Alberta T5K 2G6, Canada. (403)-427-8042. Fax: (403)-422-0975.
- Coffin, Eric and David**, Vanguard Consulting Ltd., 710 - 1185 W Georgia St., Vancouver, B.C. V6E 4E6, Canada. (604)-681-3234. Fax: (604)-688-4218.

- Crosby, Keith S.**, International Minerals Corp. (Canada) Limited, Esterhazy, Saskatoon, Saskatchewan S0A 0X0, Canada. (306)-745-5252. Fax: (306)-745-5255.
- Cross, Don**, Cross & Associates Ltd, 472 Berkley Crescent N.W., Calgary, Alberta T3K 1A8, Canada. (403)-295-8872.
- Currie, Philip**, The Royal Tyrrell Museum of Paleontology, Drumheller, Alberta T0J 0Y0. (403)-823-7707
- Dalheim, Peggy**, The Mineral Lab, Inc., 2700 Youngfield Street, Suite 105, Lakewood, CO 80215, USA. (303)-232-8708
- Das, B. (Manas)**, Western Economic Diversification, P.O. Box 2025, Saskatoon, Saskatchewan S7K 3S7, Canada. (306)-975-4816. Fax: (306)-975-5484.
- Dean, Lyndon**, Material Service Corporation, 4226 Lawndale Ave., Lyons, IL 60534, USA. (708)-442-4624. Fax: (708)-442-0294
- Dolhun, Wes**, Inland Cement Limited, 12640 - 156 St, Edmonton, Alberta T5V 1K2, Canada. (403)-447-1450. Fax: (403)-447-1923
- Edwards, Dixon**, Alberta Geological Survey, Box 8330 Station F, Edmonton, Alberta T6H 5X2, Canada. (403)-438-7636. Fax: (403)-438-3364
- Farris, Lauch F.**, Fargo Resources Limited, 10th Floor 900 W. Hastings Street, Vancouver, B.C. V6C 1E5, Canada. (604)-684-4246. Fax: (604)-684-9959
- Fowler, John H.**, Nova Scotia Department of Mines and Energy, P.O. Box 1087, Halifax, Nova Scotia B3J 2X1, Canada. (902)-424-4161. Fax: (902)-424-0528.
- Fox, Campbell**, Industrial Mineral Consultant, R.R. #4, Huntsville, Ontario P0A 1K0, Canada. (705)-635-1538. Fax: (705)-635-1538
- Fuenning, Paul**, Paul Fuenning and Associates Ltd, 7027 Kenossee Place SW, Calgary, Alberta T2V 2L6, Canada. (403)-255-6232
- Fuller, J. Osborne**, Ohio State, 3928 Fairlingron Dr., Columbus, OH 43220, USA. (614)-451-0070
- Ganis, G. Robert**, Tethys Consultants Inc., 2001 N. Front St., Suite 234, Bldg #3, Harrisburg, PA 17102, USA. (717)-233-7625. Fax: (717)-233-5054
- Gent, Malcolm**, Saskatchewan Energy and Mines, Sed. Geodata Branch, 1914 Hamilton St., Regina, Saskatchewan S4P 4V4, Canada. (306)-787-2646. Fax: (306)-787-2488.
- Goldsmith, M. Clare**, 3M Company, 900 Bush Ave., St. Paul, MN 55133, USA. (612)-778-4962. Fax: (612)-778-6054
- Grisafe, David A.**, Kansas Geological Survey, 1930 Constant Avenue, University of Kansas, Lawrence, KS 66047, USA. (913)-864-3965. Fax: (913)-864-5317
- Grond, H.C.**, Polestar Exploration Inc., 701 - 675 Hastings St., Vancouver, B.C. V5K 1C4, Canada. (604)-684-6287. Fax: (604)-684-6270.
- Gulick, Charles**, Department of Natural Resources/Geology, MS:P4-12, Olympia, WA 98504, USA. (206)-459-6372. Fax: (206)-459-6380.
- Guliov, Paul**, Saskatchewan Energy & Mines, 1914 Hamilton St., Regina, Saskatchewan S4P 4V4, Canada. (306)-787-2583. Fax: (306)-787-7338
- Gunning, Donald F.**, International Marble & Stone Co. Ltd., 19287 98A Avenue, Surrey, B.C. V3T 4W2, Canada. (604)-888-3848. Fax: (604)-888-5671
- Halabura, Steve P.**, North Rim Exploration Ltd., suite 106, 1001 3rd Avenue N, Saskatoon, Saskatchewan S7K 2K5, Canada. (306)-244-4878. Fax: (306)-653-1619.
- Hamilton, Wylie N.**, Alberta Geological Survey, Box 8330 Station F, Edmonton, Alberta T6H 5X2, Canada. (403)-438-7634. Fax: (403)-438-3364.
- Hancock, Kirk**, B.C. Geological Survey, 300 - 756 Fort St., Victoria, B.C. V8W 3A3, Canada. (604)-387-3243. Fax: (604)-356-8153
- Harper, Glen**, Golden Rule Resources Ltd., #410, 1122 - 4th St. S.W., Calgary, Alberta T2R 1M1, Canada. (403)-233-7898. Fax: (403)-266-2606.
- Harrison, Rand**, Alberta Geological Survey, Box 8330 Station F, Edmonton, Alberta T6H 5X2, Canada. (403)-438-7615. Fax: (403)-438-3364.
- Hart, Mitchell J.**, Monsanto Co., P.O. Box 816, Soda Springs, ID 83276, USA. (208)-547-3391. Fax: (208)-547-3312.
- Harvey, Dr Colin**, Haydn Murray and Associates, Bloomington, Indiana, USA.
- Heter, John C.**, P.W. Gillibrand Co., 5131 Tapo Cyn. Rd., Simi Valley, CA 93063, USA. (805)-526-2195. Fax: (805)-522-4031.
- Hill, Robert L.**, California Division of Mines & Geology, 107 South Broadway, Suite 1065, Los Angeles, CA 90012, USA. (213)-620-3560.
- Hinton, John L.**, Georgia Minerals Company, 24 Nathan Circle, Alpharetta, GA 30201, USA. (404)-442-8962. Fax: (404)-664-8285.
- Hodgins, John A.**, Morgan Hydrocarbons Inc., Suite 2200, 205 5 Ave. S.W., Calgary, Alberta T2P 2V7, Canada. (403)-298-8300. Fax: (403)-298-8390

- Hogg, Verne**, Ranchmans Stable Products Ltd., #2112, 13045 - 6 St SW, Calgary, Alberta, Canada. (403)-238-4964.
- Holmes, David A.**, Dunn-Behre Dolbear & Co., Inc., 1601 Blake street, Suite 510, Denver, CO 80202, USA. (303)-620-0020. Fax: (303)-620-0024.
- Holter, Milton E.**, Minprobe Consultants Ltd., 1052 Lake Christina Way S.E., Calgary, Alberta T2J 2R3, Canada. (403)-278-0546. Fax: (403)-278-9370.
- Holtz, Willard I.**, Energy, Mines and Resources, Mineral Policy Sector, 520 - 1809 Barrington St., Halifax, Nova Scotia B3J 3K8, Canada. (902)-426-3790. Fax: (902)-426-7332.
- Hopkins, David A.**, J.E. Baker Co., 320 North Baker Rd., York, PA 17404, USA. (717)-792-3683. Fax: (717)-792-2309.
- Hora, Z.Danny**, B.C. Geological Survey, 3657 Doncaster Drive, Victoria, B.C. V8P 3W8, Canada. (604)-356-2846
- Horne, Emmet**, Terracon Geotechnique Ltd., Suite 800, 633 - 6th Ave. SW, Calgary, Alberta T2P 2Y5, Canada. (403)-266-1150. Fax: (403)-233-0841
- Howard, J. Michael (Mike)**, Arkansas Geological Commission, 3815 W. Roosevelt Road, Little Rock, AR 72204, USA. (501)-324-9165.
- Hudson, Brian**, Alberta Department of Energy, 9915 - 108 Street, Edmonton, Alberta T5K 2C9, Canada. (403)-427-7749. Fax: (403)-422-1123
- Hunt, C. Warren**, Industrial Coal & Minerals Ltd, 1119 Sydenham Rd. SW, Calgary, Alberta T2T 0T5, Canada. (403)-244-3004. Fax: (403)-229-1661
- Huss, Fred**, Mountain Minerals Co. Ltd, P.O. Box 700, Lethbridge, Alberta T1J 3Z6, Canada. (403)-329-0443. Fax: (403)-328-9110
- Inverarity, C.W.**, Hunter Resources Ltd., 3916 - 17 St. SW, Calgary, Alberta T2T 4P2, Canada. (403)-243-5605
- Ionides, George N.**, Temanex Consulting Inc., President, 1403 Bewicke Avenue, N. Vancouver, B.C. V7M 3C7, Canada. (604)-986-7523. Fax: (604)-986-7152.
- Jarrett, F.W. (Rick)**, Westroc Industries Limited, P.O. Bpox 217, Invermere, B.C. V0A 1K0, Canada. (604)-342-9410. Fax: (604)-342-6311.
- Jenkins, David**, Grefco Inc., P.O. Box 939, Lompoc, CA 93438, USA. (805)-736-4581. Fax: (805)-736-5994.
- Johnson, Gordon E.**, Great Lakes Mineral Corp., 3339 Clyde Drive, Port Huron, MI 48060, USA. (313)-385-4859
- Kane, Malcolm**, Mountain Minerals Co. Ltd, P.O. Box 700, Lethbridge, Alberta T1J 3Z6, Canada. (403)-329-0443. Fax: (403)-328-9110
- Kende, John**, The Orthoshop, 1723 - 27 Avenue NE, Calgary, AB T2E 7E1, Canada. (403)-250-7830. Fax: (403)-291-9327.
- Kitzan, Paul**, Shell Canada Limited, 1043 Edgemont Rd. NW, Calgary, Alberta T3A 2J5, Canada. (403)-691-3229. Fax: (403)-269-6768
- Klosterman, Gregory E.**, American Aggregates Corp., 6450 Sand Lake Rd., Dayton, OH 45414, USA. (513)-454-1128. Fax: (513)-237-4791
- Krueger, Al**, Dravo Basic Materials, Box 2068, Mobile, AL 36652, USA. (205)-432-2651.
- Lacombe, Randall**, Highland Talc, 165 Hardin St., Ft. McMurray, Alberta T9H 2G1, Canada. (403)-790-2036
- Lefebure, David**, B.C. Geological Survey Branch M.E.M.P.R., Rm 200 - 756 Fort Street, Victoria, B.C. V8W 3A3, Canada. (604)-356-2834. Fax: (604)-356-8153
- Linkous, Mike**, U.S. Borax, 6516 Falls of Neuse Rd. #100, Raleigh, NC 27615, USA. (919)-954-0147. Fax: (919)-954-0143
- Lizak, John**, The Millington Group, P.O. Box 407, Millington, NJ 07946, USA. (201)-580-3910. Fax: (201)-580-3909
- Loyd, Ralph**, California Division of Mines & Geology, 650-B Bercut Drive, Sacramento, CA 95814, USA. (916)-323-8562
- Lutz, Jennie**, Alberta Research Council, Box 8330 Station F, Edmonton, Alberta T6H 5X2, Canada. (403)-438-7571. Fax: (403)-430-0839
- Madunicky, Mika**, Alberta Research Council, Box 8330 Station F, Edmonton, Alberta T6H 5X2, Canada. (403)-438-7609. Fax: (403)-438-3364
- Manz, Ronald L.**, Wicked River Resources Ltd., P.O. Box 5668 Station A., Calgary, Alberta T2H 1Y1, Canada. (403)-264-8262
- Marcille-Kerslake, Virginia**, University of Guelph, Land Resource Science, Guelph, Ontario N1G 2W1, Canada. (519)-824-4120. Fax: (519)-824-5730.
- Mathieu, Gilles**, Dept. of Energy, Mines & Resources, 552 Booth St., Ottawa, Ontario K1A 0G1, Canada. (613)-995-3693. Fax: (613)-992-9389.
- Meijer Drees, N.C.**, ISPG, 3303 - 33 St. NW, Calgary, Alberta T2L 2A7, Canada.
- Meyer, Jamie**, Newfoundland Department of Mines and Energy, 98 Bonaventure Ave., P.O. Box 8700, St.

- John's, Newfoundland A1B 4J6, Canada. (709)-576-5968. Fax: (704)-576-3443.
- Mills, Doral S., Dry Branch Kaolin Co., Rt. 1 Box 468 D, Dry Branch, GA 31021, USA. (912)-750-3650. Fax: (912)-750-3643
- Montgomery, Joe, Polestar Exploration Inc., 701 - 675 W. Hastings St., Vancouver, B.C. V6B 1N2, Canada. (604)-684-6287.
- Morel-a-PHuissier, Patrick, Mineral Policy Sector, EMR, Room 622, 460 O'Connor Street, Ottawa, Ontario K1A 0E4, Canada. (613)-992-3258. Fax: (613)-992-5893
- Morton, Paul, P.K. Morton & Associates, P.O. Box 11448, Costa Mesa, CA 92627, USA. (714)-642-9805
- Mossop, Grant, Alberta Geological Survey, Box 8330 Station F, Edmonton, Alberta T6H 5X2, Canada. (403)-438-7657. Fax: (403)-438-3364
- Macgregor, D.H.G., BC Trade Development Corp., 999 Canada Place, Suite 130, Vancouver, B.C., Canada. Fax: (604)-660-2457.
- MacLean, Mary, B.C. Ministry of Energy, Mines and Petroleum Resources, 756 Fort Street, Rm 300, Victoria, B.C. V8V1X4, Canada. (604)-356-2845. Fax: (604)-356-8153.
- McArthur, Gilbert, B.C. Geological Survey, 200 - 756 Fort St., Victoria, B.C. V8V 1X4, Canada. (604)-356-2839. Fax: (604)-356-8153
- McClave, Michael A., ASARCO, Inc., E.920 Wolverton Ct., Spokane, WA 99207-2784, USA. (509)-489-7870. Fax: (509)-483-0131
- McCosh, Rick, F.D. McCosh Resource Consultants Ltd., 15 Templemont Drive N.E., Calgary, Alberta T1Y 4Z5, Canada. (403)-280-2053
- Newman, Tom, J.M. Huber Corp, Box 4005, Quincy, IL 62305, USA. (217)-224-1100. Fax: (217)-224-7957
- Nikols, Dennis, Alberta Geological Survey, P.O. Box 8330 Station F, Edmonton, Alberta T6H 5X2, Canada. (403)-438-7622. Fax: (403)-438-3364
- O'Connor, Bruce J., Georgia Geologic Survey, 19 M.L. King Jr. Dr. SW, Atlanta, GA 30087, USA. (404)-656-3214
- O'Neil, Patrick R., Unified Chemistry, 658 Ioco Rd., Port Moody, B.C., Canada. (604)-469-1751.
- Olmsted, Bill, School District #03, 604 Moyie St., Kimberley, B.C. V1A 2N9, Canada. (604)-427-3627
- Olson, Richard H., Industrial Minerals Evaluations, Inc., 1536 Cole Blvd. Suite 320, Golden, CO 80401, USA. (303)-239-9250. Fax: (303)-232-0501
- Ouellette, Dennis, Geological Services, NAP, 200 Range Road, Whitehorse, Yukon Y1A 3V1, Canada. (403)-667-3205. Fax: (403)-668-4070.
- Page, Jay W., Westex Exploration Ltd, 515 - 510 West Hastings Street, Vancouver, BC V6B 1L8, Canada. (604)-687-5064
- Papke, Keith G., Consultant, 2180 Schroeder Way, Sparks, NV 89431, USA. (702)-358-3095
- Peach, Allister R., 812 Coach Bluff Cres. S.W., Calgary, Alberta T3H 1A8, Canada. (403)-246-6534
- Peel, Don, Alberta Forestry, Lands and Wildlife, 802 , 10531 - 90 Street, Edmonton, Alberta T5H 4E7, Canada. (403)-427-6597. Fax: (403)-422-4244
- Pell, Jennifer, Formosa Resources, 3011 Quadra, Victoria, B.C. V8T 4G2, Canada. (604)-385-6463.
- Pickering Jr., Sam M., 1414 Twin Pines Dr., Macon, GA 31211, USA. (912)-743-9323. Fax: (912)-743-9323
- Poling, George W., B.C. Mining Association, #860 - 1066 West Hastings St., Vancouver, B.C. V6E 3X1, Canada. (604)-684-9918. Fax: (604)-681-5305.
- Poulin, Richard, University of British Columbia, Dept. of Mining and Min. Proc. Eng., 6350 Stores Road, Vancouver, B.C. V6T 1Z4, Canada. (604)-822-4725. Fax: (604)-822-5599
- Power, W.R. (Bob), P.O. Box 704, Frisco, CO 80443, USA. (303)-668-3616
- Prentice, Mike, Alberta Geological Survey, Box 8330 Station F, Edmonton, Alberta T6H 5X2, Canada. (403)-438-7619. Fax: (403)-438-3364
- Prentice, John E., Eastwood, Gt. Comberton, Pershore, Worcestershire WR10 3DT, England. 038-674-244
- Price, Monica, Alberta Geological Survey, Box 8330 Station F, Edmonton, Alberta T6H 5X2, Canada. (403)-438-7631
- Rafuse, Ivan N., Indian and Northern Affairs, Les Terrasses de la Chaudiere, Ottawa, Ontario K1A 0H4, Canada. (819)-997-8363. Fax: (819)-953-3323.
- Richardson, Rick, Alberta Geological Survey, P.O. Box 8330 Station F, Edmonton, Alberta T6H 5X2, Canada. (403)-438-7623. Fax: (403)-438-3364.
- Riordan, Richard F., Geomapping Assoc. Ltd., 2674 Robidoux Rd., Sandy, Utah 84093, USA. (801)-943-3062. Fax: (801)-943-4110
- Rogan, Mervyn, Ram Industrial Minerals Ltd, Box 300, Morinville, Alberta T0G 1P0, Canada. (403)-939-3033. Fax: (403)-939-3044

- Root, Robert L.**, Consultant, P.O. Box 16156, Las Cruces, NM 88004, USA. (505)-524-1649
- Santini, Ken**, Santini and Associates, 1917 Sage Circle, Golden, Colorado 80401, USA. (303)-277-1807. Fax: (303)-278-0092.
- Scafe, Don**, Alberta Geological Survey, Box 8330 Station F, Edmonton, Alberta T6H 5X2, Canada. (403)-438-7633. Fax: (403)-438-3364
- Schultes, Dr. Hagen**, Baymag, 800 10655 southport Road SW, Calgary, Alberta T2W 4Y1, Canada. (403)-271-9400. Fax: (403)-271-0010
- Scott, Dale**, Ontario Ministry of Natural Resources, 10 Irongate Place, Brantford, Ontario N3R 5V5, Canada. (416)-965-6712. Fax: (416)-324-6714
- Sears, Dr. Tim**, Baymag, 800 Southport Road, Calgary, Alberta T2W 4Y1, Canada. (403)-271-9400. Fax: (403)-271-0010
- Shayna, Michael**, I-XL Industries Ltd., P.O. Box 70, Medicine Hat, Alberta T1A 7E7, Canada. (403)-526-5901. Fax: (403)-526-7680.
- Shelden, Jim**, U.S. Forest Service, Region 1 Box 7669, Missoula, MT 59807, USA. (406)-329-3577. Fax: (406)-329-3347
- Simandl, George J.**, Geological Survey Branch, Ministry of Energy, Mines and Petroleum Resources, Parliament Buildings, Victoria, B.C. V8V 1X4, Canada. (604) 387-3242. Fax: (604)-356-8153
- Simard, Claudette**, West Virginia Geological Survey, P.O. Box 879, Morgantown, WV 265070879, USA. (304)-594-2331. Fax: (304)-594-2575
- Singh, Ronald**, Mountain Minerals Co. Ltd, P.O. Box 700, Lethbridge, Alberta T1J 3Z6, Canada. (403)-329-0443. Fax: (403)-328-9110
- Smyth, Walter (Ron)**, B.C. Geological Survey, B.C. Ministry of Mines, Parliament Bldgs., Victoria, B.C. V8V 5W9, Canada. (604)-387-0687. Fax: (604)-356-8153.
- Spilsbury, Wayne**, Teck Exploration Ltd., 1199 West Hastings St., Vancouver, B.C. V6E 2K5, Canada. (604)-687-1117. Fax: (604)-687-6100.
- Steuart, Charles**, Malvern Minerals Co., P.O. Box 1238, Hot Springs, AR 71902-1238, USA. (501)-623-8893. Fax: (501)-623-5113
- Sweet, Palmer C.**, Virginia Division of Mineral Resources, P.O. Box 3667, Charlottesville, VA 22903, USA. (804)-293-5121. Fax: (804)-293-2239
- Termuende, Robert**, RWT Project Management, P.O. Box 7, Ft. Steele, B.C. V0B 1N0, Canada. (604)-426-6000.
- Termuende, Tim**, Toklat Resources, Inc., 1701 Mt. Nelson Cres., Cranbrook, B.C. V1C 5V6, Canada. (604)-426-3112. Fax: (604)-426-6899.
- Timmons, Bobby J.**, Timmons Associates, P.O. Box 50606, Jacksonville Beach, FL 32240, USA. (904)-246-4533, 241-4907. Fax: (904)-249-0459
- Vandenbussche, Brad**, Norwest Mine Services, 400 205 - 9 Ave. SE, Calgary, Alberta T2G 0R3. (403)-237-7763. Fax: (403)-263-4086
- Vandervelde, Rene**, Korite Minerals Ltd., 532 38A Ave. SE, Calgary, Alberta T2G 1X4, Canada.
- Watson, Barry N.**, U.S. Borax, 6516 Falls of Neuse Rd. #100, Raleigh, NC 27615, USA. (919)-954-0149. Fax: (919)-954-0143
- Webb, Tim**, New Brunswick Dept. of Natural Resources and Energy, P.O. Box 6000, Fredericton, New Brunswick E3B 5H1. (506)-453-2206. Fax: (506)-453-3671.
- Westcott, James F.**, A.P. Green Industries (retired), 7 Branchwood Rd., Mexico, MO 65265, USA. (314)-581-3732.
- Wheeler, Alfred H.**, Magnesium Company of Canada, Ste 1120 10201 Southport Rd. SW, Calgary, Alberta T2W 4X9, Canada. (403)-652-3997 Fax: (403)-652-3998
- White, Melvyn G.**, Public Lands Div., Forestry, Lands and Wildlife Alberta, 11226 - 52 St., Edmonton, Alberta T5W 3H9, Canada. (403)-427-3570 Fax: (403)-422-4251.
- Williams, Barrett J.**, Norfolk Southern Corporation, 185 Spring St. S.W., Atlanta, GA 30303, USA. (404)-529-1853 Fax: (404)-529-1057
- Wise, Sandy**, Western Industrial Clay Products Ltd., 714 East Sarcee Street, Kamloops, B.C. V2H 1E7, Canada. (604)-372-1600. Fax: (604)-372-3777.
- Wood, Brad**, Unit 6 1112 Russell St., Thunder Bay, Ontario P7B 5N2, Canada. (807)-623-9377 Fax: (807)-623-7202.
- Zdunczyk, Mark J.**, Dunn Geoscience Corporation, 12 Metro Park Road, Albany, NY 12205, USA. (518)-458-1313. Fax: (518)-458-2472.